

Datasheet

CFM600S Series

FORTEC
UNITED STATES

FORTEC
INTEGRATED

FORTEC
UNITED KINGDOM

The information contained in this document has been carefully researched and is, to the best of our knowledge, accurate. However, we assume no liability for any product failures or damages, immediate or consequential, resulting from the use of the information provided herein. Our products are not intended for use in systems in which failures of product could result in personal injury. All trademarks mentioned herein are property of their respective owners. All specifications are subject to change without notice.



CFM600S SERIES 600 WATT AC-DC POWER SUPPLY WITH PFC

Features

- Universal Input Range 80~264V_{ac}
- High Efficiency up to 94.5%
- 3"x 5" Compact Size
- Class I & Class II
- No Load Power Consumption<1W
- Approval IEC/EN/UL 62368-1
- Approval EN 55032, 47 CFR FCC Part 15
- Active PFC Meets EN 61000-3-2
- Design Meets IEC/EN 60335-1
- Operating Altitude 5000m
- High Power Density up to 25.97W/Inch³
- Up to 510W Natural, 600W Conduction Convection
- Over Temperature Protection
- PS On/Off Remote Control
- Power Good & Power Fail Signal
- +5V Stand-by, 12V Fan Output
- Low Inrush Current



MODEL NUMBER	OUTPUT VOLTAGE	OUTPUT CURRENT			VOLTAGE ACCURACY NOTE1	RIPPLE& NOISE NOTE2	VOLTAGE ADJ. RANGE	LINE REGULATION NOTE3	LOAD REGULATION NOTE4	%EFF. (Typ.)
		FAN	COVER	OPEN						
CFM600S120	12 V	50.00 A	32.08 A	26.25 A	±1%	120 mV	11.4~12.6 V	±0.5%	±1%	92.5%
CFM600S150	15 V	40.00 A	25.67 A	21 A	±1%	150 mV	14.25~15.75 V	±0.5%	±1%	93.0%
CFM600S180	18 V	33.33 A	21.39 A	17.5 A	±1%	180 mV	17.1~18.9 V	±0.5%	±1%	93.5%
CFM600S240	24 V	25.00 A	18.33 A	16.875 A	±1%	180 mV	22.8~25.2 V	±0.5%	±1%	94.5%
CFM600S280	28 V	21.42 A	15.71 A	14.46 A	±1%	200 mV	26.6~29.4 V	±0.5%	±1%	94.5%
CFM600S300	30 V	20.00 A	14.67 A	13.5 A	±1%	200 mV	28.5~31.5 V	±0.5%	±1%	94.5%
CFM600S360	36 V	16.66 A	12.22 A	11.25 A	±1%	200 mV	34.2~37.8 V	±0.5%	±1%	94.5%
CFM600S480	48 V	12.50 A	9.17 A	8.44 A	±1%	250 mV	45.6~50.4 V	±0.5%	±1%	94.5%
Stand-by Output Voltage										
CFM600SXXX	+5V	1A			±3%	100 mV	---	±1%	±5%	---
CFM600SXXXC		0.5A			±3%	100 mV	---	±1%	±5%	---
CFM600SXXXF	+5V	0.5A			±3%	100 mV	---	±1%	±5%	---
Fan Output Voltage										
All	+12V	0.5A (NOTE 5)			11.6 ~ 13.5V (NOTE 6)	---	---	---	---	---

Note:

1. Voltage accuracy is set at 100% full load and 25°C Ta.
2. Add a 0.1uF ceramic capacitor and a 10uF E.L. capacitor to output for ripple & noise measuring @20MHz BW.
3. Line regulation is measured from high line to low line with 100% full load.
4. Load regulation is measured from 10% to 100% full load.
5. Fan output can only operate normal when the stand-by output is above 0.5A.
6. CFM600SXXX & CFM600SXXXC: Stand-by output load 1A, fan output load 0.5A.
CFM600SXXXF: Stand-by output load 0.5A, fan output load 0.5A.



CFM600S Series

PART NUMBER

Series	Number of Outputs	Nominal Output Voltage	Type	Output Terminal
CFM600	X	XXX	X (Option)	-X(Option)
CFM600	S : Single	120 : 12V 150 : 15V 180 : 18V 240 : 24V 280 : 28V 300 : 30V 360 : 36V 480 : 48V	None : With Baseplate C : With Cover F : With Fan	None : Vertical R : Horizontal

Part Number Example:

CFM600S120: With Baseplate, 600W, 12Vdc Output, Vertical Type Terminal

CFM600S120C: With Cover, 600W, 12Vdc Output, Vertical Type Terminal

CFM600S120F: With Fan, 600W, 12Vdc Output, Vertical Type Terminal

CFM600S120-R: With Baseplate, 600W, 12Vdc Output, Horizontal Type Terminal



CFM600S Series

TECHNICAL SPECIFICATIONS

(All specifications are typical at nominal input, full load at 25°C unless otherwise noted.)

ABSOLUTE MAXIMUM RATINGS

PARAMETER	NOTES and CONDITIONS	Device	Min.	Typ.	Max.	Units
Input Voltage	Safety approvals only to the AC input	All	80		264	V _{ac}
Operating Temperature	See derating curve	All	-40		85	°C
Maximum Case Temperature	At the Center of Base Plate (T _c =Case temperature)	All	-40		90	°C
Storage Temperature		All	-40		85	°C
Operating Altitude		All			5000	m

INPUT CHARACTERISTICS

PARAMETER	NOTES and CONDITIONS	Device	Min.	Typ.	Max.	Units
Operating Voltage Range		All	100		240	V _{ac}
Input Frequency Range		All	47		63	Hz
Maximum Input Current	100% Full Load, V _{in} =100V _{ac}	All			7.2	A
Power Factor	V _{in} =230V _{ac}	All		0.97		
Leakage Current (Earth)		All			300	uA
Leakage Current (Touch)		All			100	uA
Inrush Current	V _{in} =240V _{ac} , Cold start at 25°C	All		8.5		A

OUTPUT CHARACTERISTICS

PARAMETER	NOTES and CONDITIONS	Device	Min.	Typ.	Max.	Units
Output Voltage Set Point	V _{in} =Nominal V _{in} , I _o =I _o max., T _c =25°C	CFM600S120	11.88	12	12.12	V _{dc}
		CFM600S150	14.85	15	15.15	
		CFM600S180	17.82	18	18.18	
		CFM600S240	23.76	24	24.24	
		CFM600S280	27.72	28	28.28	
		CFM600S300	29.70	30	30.30	
		CFM600S360	35.64	36	36.36	
		CFM600S480	47.52	48	48.48	
Operating Output Current Range	V _{in} =80V _{ac} ~264V _{ac} , see derating curve	CFM600S120			50.00	A
		CFM600S150			40.00	
		CFM600S180			33.33	
		CFM600S240			25.00	
		CFM600S280			21.42	
		CFM600S300			20.00	
		CFM600S360			16.66	
		CFM600S480			12.50	
Holdup Time	V _{in} =115V _{ac}	All		12		ms
Output Voltage Regulation						
Load Regulation	10% to 100% full load	All			±1.0	%
Line Regulation	V _{in} =High line to low line	All			±0.5	%
Over Voltage Protection	Latch off (AC recycle to reset)	CFM600S120			16	V _{dc}
		CFM600S150			25	
		CFM600S180			25	
		CFM600S240			35	
		CFM600S280			35	
		CFM600S300			35	
		CFM600S360			50	
		CFM600S480			60	



CFM600S Series

PARAMETER	NOTES and CONDITIONS	Device	Min.	Typ.	Max.	Units
Over Current Protection	Auto recovery	All	120		190	%
Short Circuit Protection	Auto recovery	All				
Over Temperature Protection	Auto recovery	All				
Output Ripple and Noise	1. Add a 0.1uF ceramic capacitor and a 10uF aluminum electrolytic capacitor to output 2. Oscilloscope is 20MHz bandwidth 3. Ambient temperature=25°C	CFM600S120 CFM600S150 CFM600S180 CFM600S240 CFM600S280 CFM600S300 CFM600S360 CFM600S480			120 150 180 180 200 200 200 250	mV
Load Capacitance	1. $V_{in}=115V_{ac}$ and $230V_{ac}$ 2. Output is 100% full load 3. Ambient temperature=25°C	CFM600S120 CFM600S150 CFM600S180 CFM600S240 CFM600S280 CFM600S300 CFM600S360 CFM600S480			50000 40000 33000 25000 21420 20000 16670 12500	uF
Efficiency	1. $V_{in}=230V_{ac}$ 2. Output is 100% full load 3. Ambient temperature=25°C	CFM600S120 CFM600S150 CFM600S180 CFM600S240 CFM600S280 CFM600S300 CFM600S360 CFM600S480		92.5 93.0 93.5 94.5 94.5 94.5 94.5		%
PS-On Signal (Absolute Maximum Rating:60V)	Power on	All	0		2	V_{dc}
	Power off (PS-ON and GND open)			4		
	Power on (PS-ON and GND short)			10		mA
	Power-off (PS-ON and GND open)			0		
Power Good (PG)	1. $V_{in}=80V_{ac}\sim 264V_{ac}$ 2. Output is 100% full load 3. The TTL goes high after power set up	All	100		500	ms
Power Fail (PF)	1. $V_{in}=80V_{ac}\sim 264V_{ac}$ 2. Output is 100% full load 3. The TTL goes low before V_o below 90% rated value	All	1	5		ms

ISOLATION CHARACTERISTICS

PARAMETER	NOTES and CONDITIONS	Device	Min.	Typ.	Max.	Units
Input to Output	1 Minute	All			4000	V_{ac}
Input to Earth (Ground)	1 Minute (without dielectric breakdown)	All			1800	V_{ac}
Output to Earth (Ground)	1 Minute (without dielectric breakdown)	All			1800	V_{ac}
Isolation Resistance	Input to output	All	100			MΩ

FEATURE CHARACTERISTICS

PARAMETER	NOTES and CONDITIONS	Device	Min.	Typ.	Max.	Units
Switching Frequency	$P_{out}=\text{max. rated power}$	All		65		kHz
Output Voltage Adjustment		All	-5		+5	%



CFM600S Series

GENERAL SPECIFICATIONS

PARAMETER	NOTES and CONDITIONS	Device	Min.	Typ.	Max.	Units
MTBF	$I_o=100\%$; $T_a=25^\circ\text{C}$ per MIL-HDBK-217F	All		145		k hours
	$I_o=100\%$; $T_a=25^\circ\text{C}$ per Telcordia SR332	CFM600SXXX CFM600SXXXC		1230		
		CFM600SXXXF		1100		
Humidity	Non-condensing	All			93	% RH
Shock	Meet MIL-STD-810F Table 516.5, Table 516.5-I 10ms, each axis 3 times ($\pm X \cdot \pm Y \cdot \pm Z$ axis)	All		75		g
Vibration	Meet MIL-STD-810F Table 514.5C-VIII, 15~2000Hz, X · Y · Z axis, 1 hour (each axis), Total 3 hrs.	All		4		g
Weight	Baseplate versions	CFM600SXXX		520		g
	Covered versions	CFM600SXXXC		640		
	Fan versions	CFM600SXXXF		710		
Dimensions	Baseplate versions	CFM600SXXX	5.00x3.00x1.539 Inches (127.0x76.2x39.10 mm)			
	Covered versions	CFM600SXXXC	5.35x3.43x1.673 Inches (136.00x87.0x42.50 mm)			
	Fan versions	CFM600SXXXF	5.35x3.43x2.68 Inches (136.0x87.0x68.1 mm)			

GENERAL SPECIFICATIONS

Safety	Class I, IEC/EN/UL 62368-1	Ed 3.0
EMC Emission	EN 55032, EN 61000-6-3 Class B EN 61000-6-4, 47 CFR FCC Part 15 Subpart B (Class B) EN 61204-3, EN 61000-3-2, EN 61000-3-3	
Conducted Disturbance	EN 55032, EN 61000-6-3, Class B EN 61000-6-4, 47 CFR FCC Part 15 Subpart B (Class B)	Class B
Radiated Disturbance	EN 55032, EN 61000-6-3, Class B EN 61000-6-4, 47 CFR FCC Part 15 Subpart B (Class B) (Class II Only Meets to Class A, Class B Must Add Parts, Refer to Application Note)	Class B
Harmonic Current Emissions	IEC 61000-3-2:2014	Class A, C
Voltage Fluctuations & Flicker	IEC 61000-3-3:2013	
EMC Immunity	EN 55035, EN 61000-6-1, EN 61000-6-2 EN 61204-3, IEC 61000-4-2, 3, 4, 5, 6, 8, 11	
Electrostatic Discharge (ESD)	IEC 61000-4-2, Level 3: Air Discharge: $\pm 8\text{kV}$, Contact Discharge: $\pm 4\text{kV}$	Criterion A
Radio-Frequency, Continuous Radiated Disturbance	IEC 61000-4-3, Level 3: 80~1000MHz, 10V/m	Criterion A
Electrical Fast Transient (EFT)	IEC 61000-4-4, Level 3: $\pm 1\text{kV}$, $\pm 2\text{kV}$	Criterion A
Surge	IEC 61000-4-5, Level 4: L-N: $\pm 0.5\text{kV}$, $\pm 1\text{kV}$, $\pm 2\text{kV}$, L-E(Ground): $\pm 0.5\text{kV}$, $\pm 1\text{kV}$, $\pm 2\text{kV}$, $\pm 4\text{kV}$	Criterion A
Conducted Disturbances, Induced by RF Fields	IEC 61000-4-6, Level 3: 0.15~80MHz, 10V	Criterion A
Power Frequency Magnetic Field	IEC 61000-4-8, Level 3: 50Hz or 60Hz, 1A/m, 3A/m, 10A/m	Criterion A
Voltage Dips	IEC 61000-4-11, Dip: 30% Reduction, Dip >95% Reduction	Criterion A
Voltage Interruptions	IEC 61000-4-11, >95% Reduction	Criterion B
Application Note Link	CFM600S Series App Notes	



CHARACTERISTIC CURVE

Power Derating Curve

Forced Air Flow

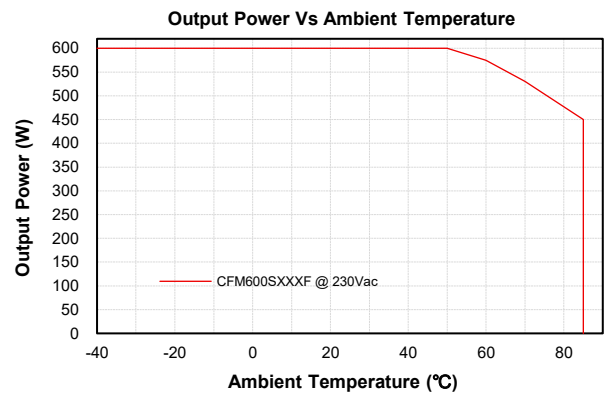
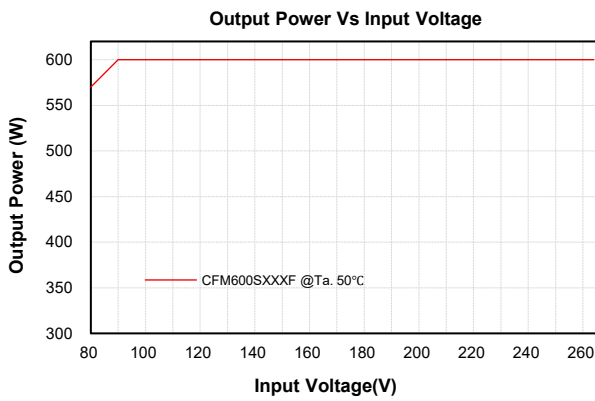
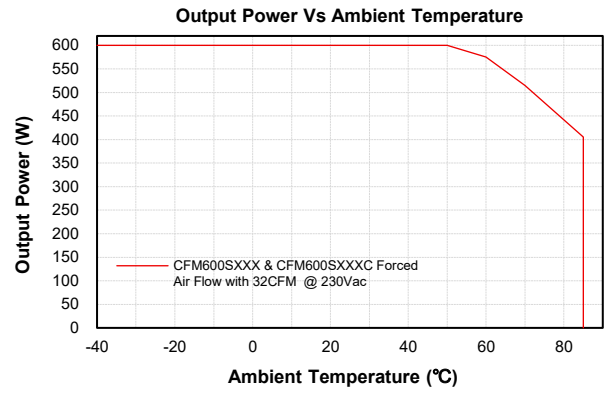
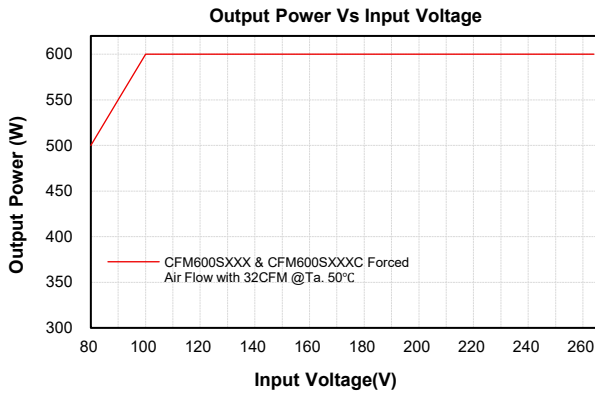



CFM600S Series

Natural Convection

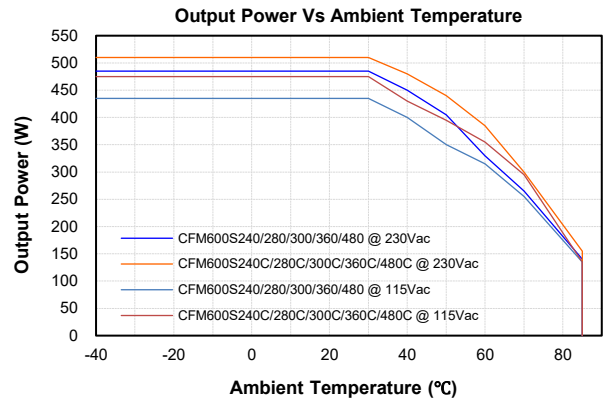
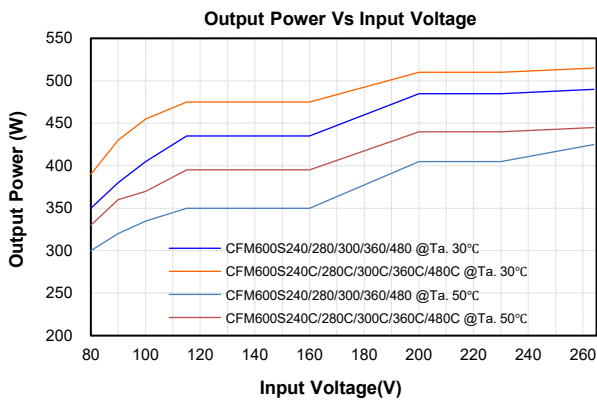
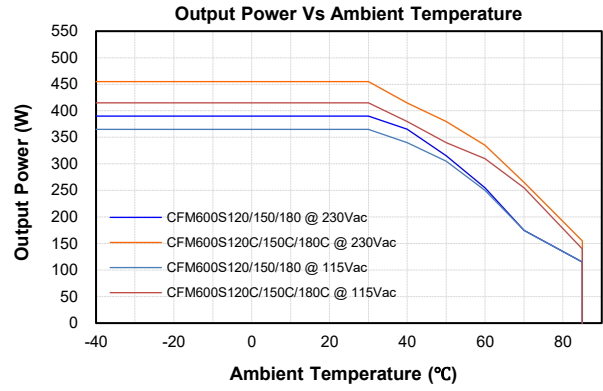
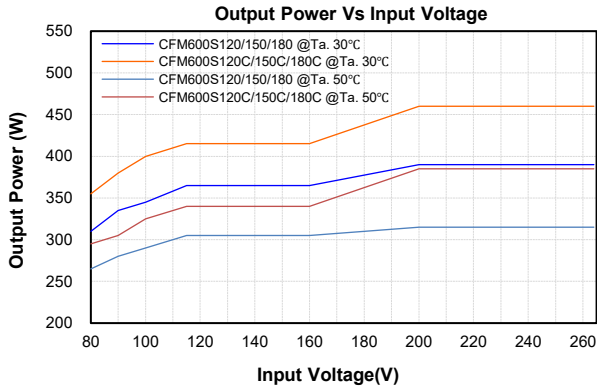



CFM600S Series

Conduction Convection with External Baseplate (43x43x0.2cm)

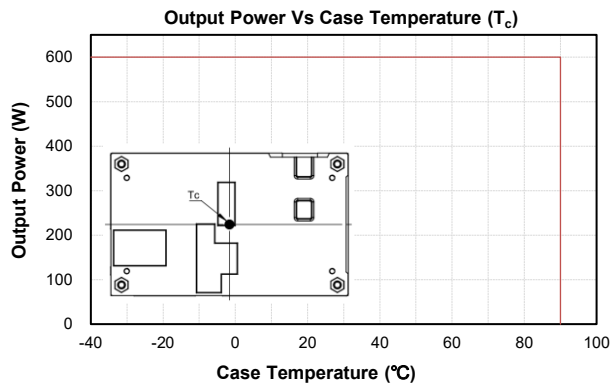
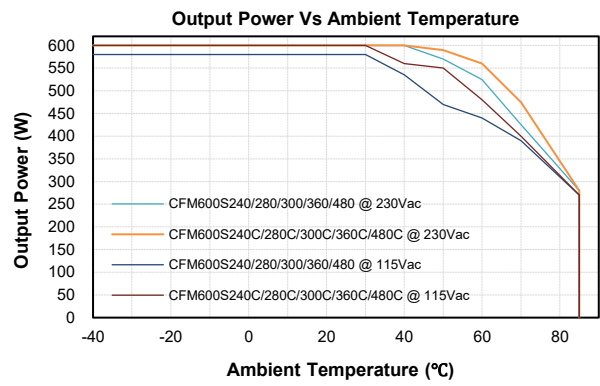
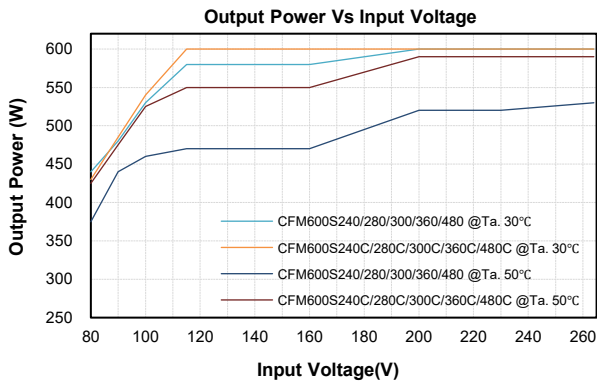
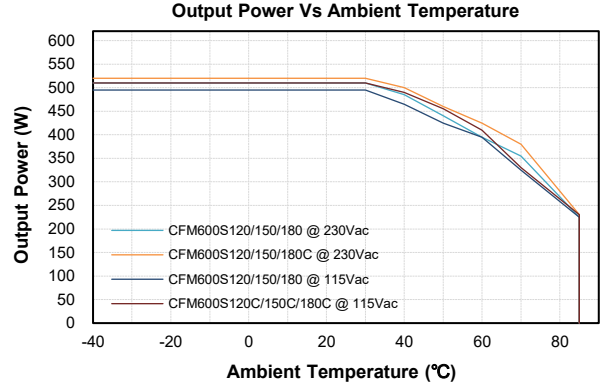
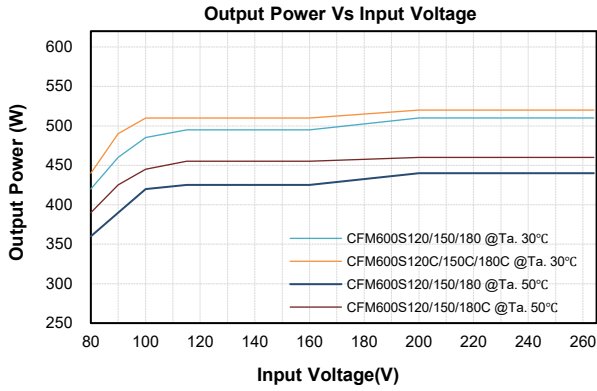



CFM600S Series

Performance Data

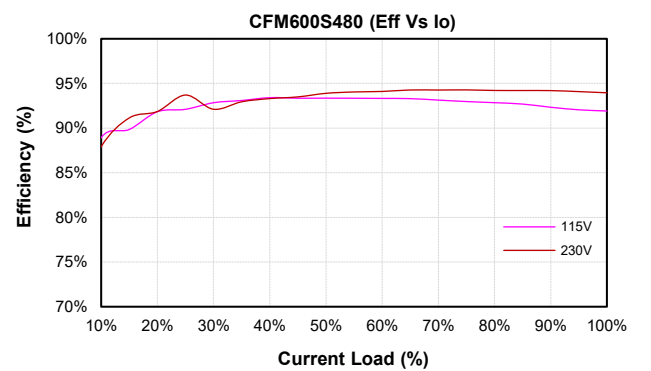
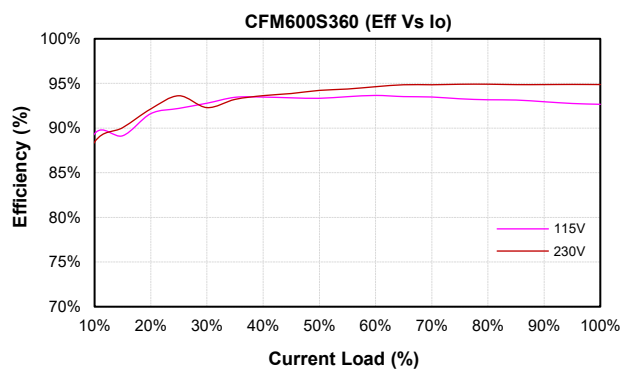
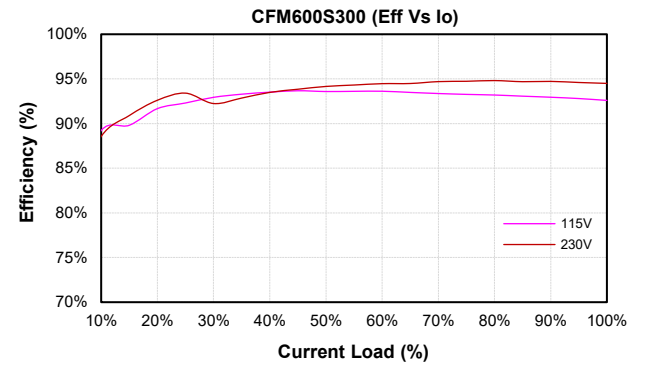
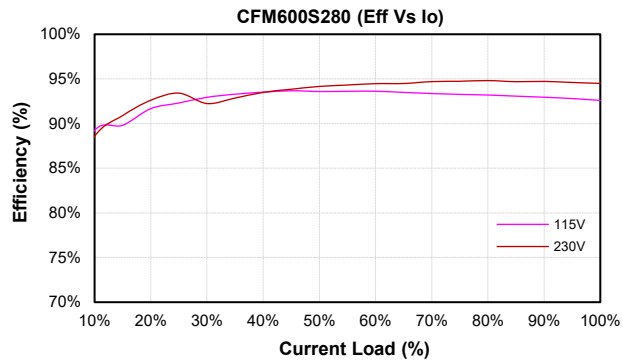
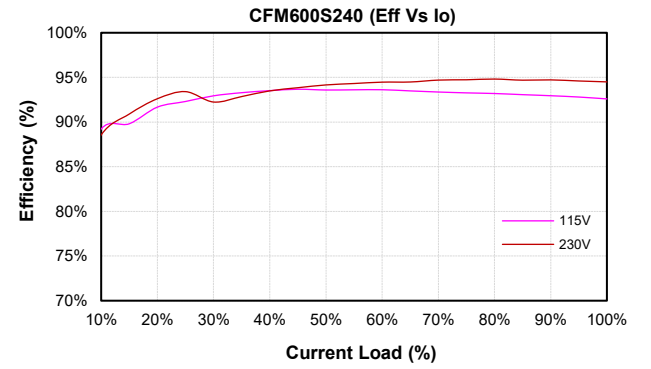
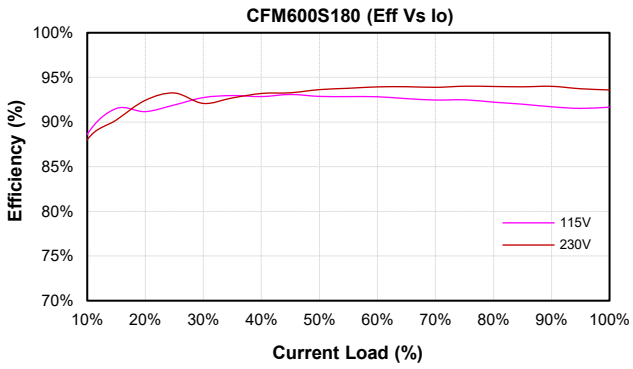
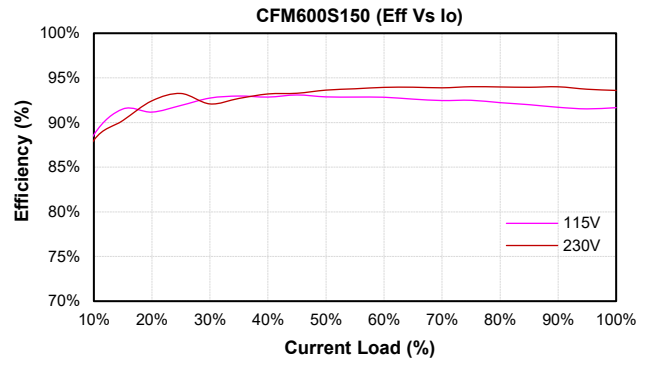
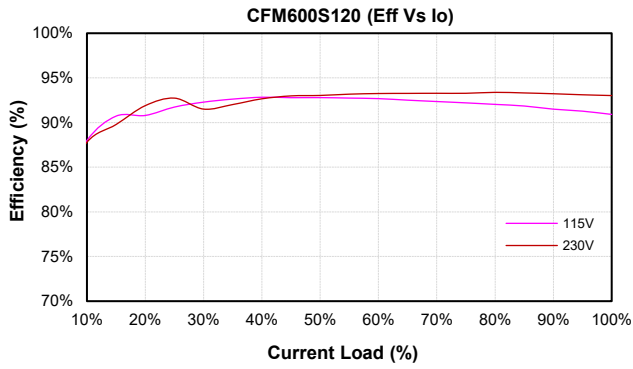

MECHANICAL SPECIFICATION

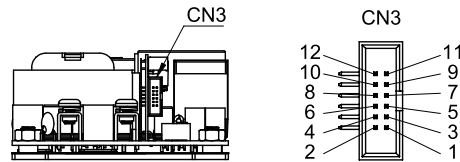
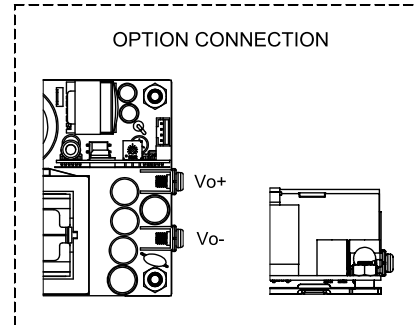
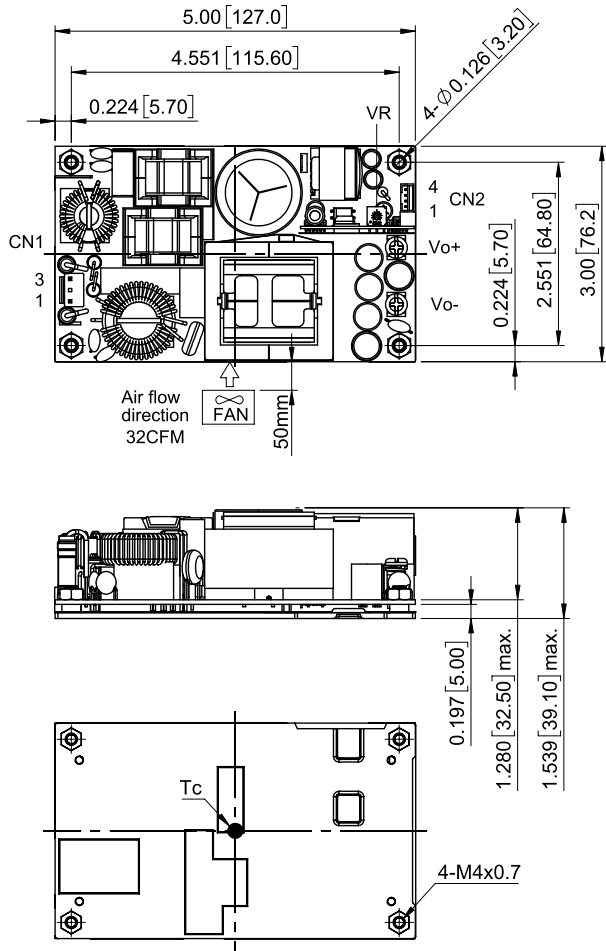

CFM600SXXX

All Dimensions in Inches[mm]
 Tolerance Inches: x.xx=±0.03, x.xxx=±0.020
 Millimeters: x.x=±0.7, x.xx=±0.50

AC Input Connector(CN1):JST B2P3-VH or equivalent

Pin	Function	Mating Housing	Terminal
1	ACL	JST VHR-3N or equivalent	JST SVH-41T-P1.1 or equivalent
2	-		
3	ACN		

DC Output Connector(CN2):TKP P110I-04 or equivalent

Pin	Function	Mating Housing	Terminal
1	GND	JST PHR-4 or equivalent	JST SPH-002T-P0.5L or equivalent
2	+5VSB		
3	GND		
4	+12V-FAN		

DC Output Connector(CN3):Townes B304F-12RGF-104-LH or equivalent

Pin	Function	Mating Housing
1	NA	Samtec FFSD-06-01-N or equivalent
2	NA	
3	NA	
4	NA	
5	NA	
6	NA	
7	PS ON/OFF	
8	GND	
9	PG/PF	
10	NA	
11	Vsns-	
12	Vsns+	

DC Output Connector:KANG YANG PCB-58M4 or equivalent

Function	The screw locked torque
Vo-	M4 7kgf-cm
Vo+	



CFM600S Series

MECHANICAL SPECIFICATION

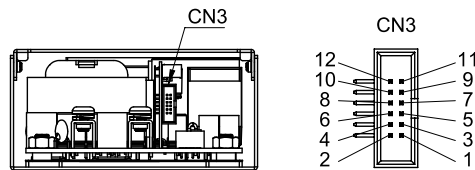
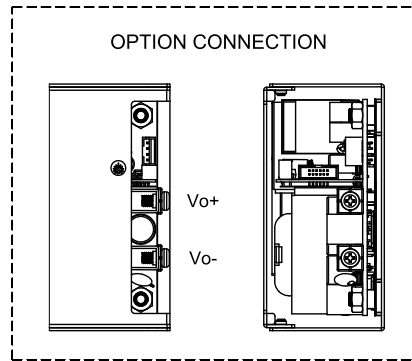
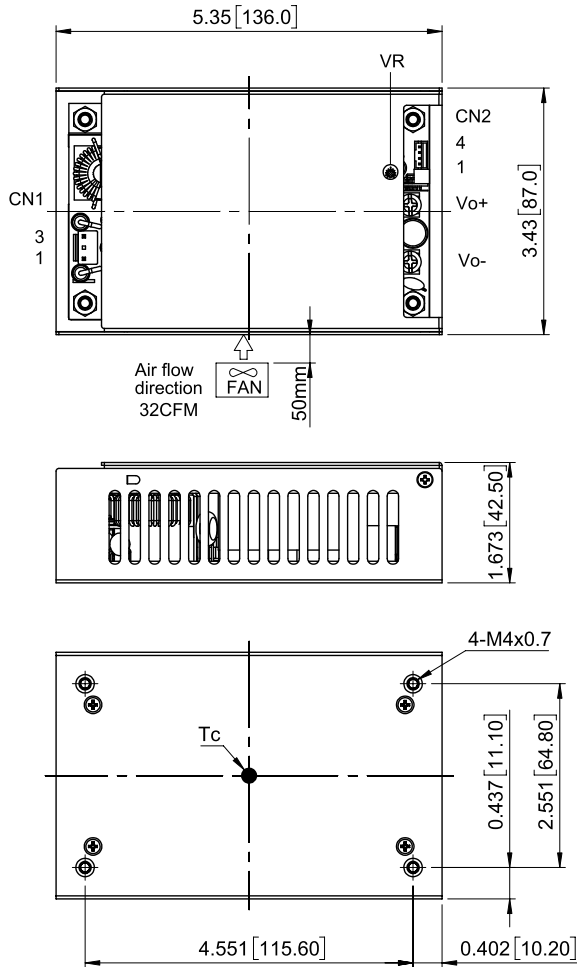

CFM600SXXXC

All Dimensions in Inches[mm]
 Tolerance Inches: x.xx=±0.03, x.xxx=±0.020
 Millimeters: x.x=±0.7, x.xx=±0.50

AC Input Connector(CN1):JST B2P3-VH or equivalent

Pin	Function	Mating Housing	Terminal
1	ACL	JST VHR-3N or equivalent	JST SVH-41T-P1.1 or equivalent
2	-		
3	ACN		

DC Output Connector(CN2):TKP P110I-04 or equivalent

Pin	Function	Mating Housing	Terminal
1	GND	JST PHR-4 or equivalent	JST SPH-002T-P0.5L or equivalent
2	+5VSB		
3	GND		
4	+12V-FAN		

DC Output Connector(CN3):Townes B304F-12RGF-104-LH or equivalent

Pin	Function	Mating Housing
1	NA	Samtec FFSD-06-01-N or equivalent
2	NA	
3	NA	
4	NA	
5	NA	
6	NA	
7	PS ON/OFF	
8	GND	
9	PG/PF	
10	NA	
11	Vsns-	
12	Vsns+	

DC Output Connector:KANG YANG PCB-58M4 or equivalent

Function	The screw locked torque
Vo-	M4 7kgf-cm
Vo+	



CFM600S Series

MECHANICAL SPECIFICATION

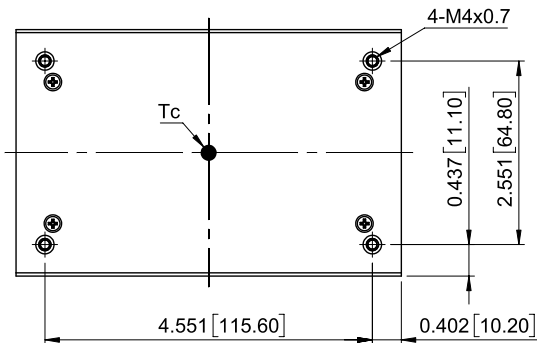
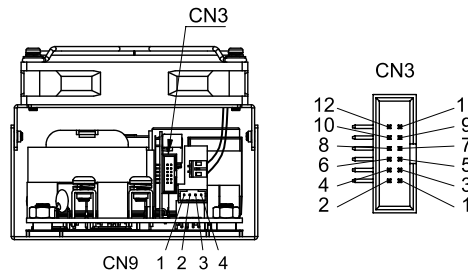
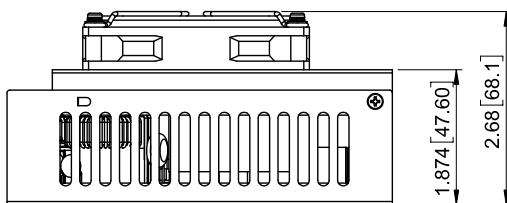
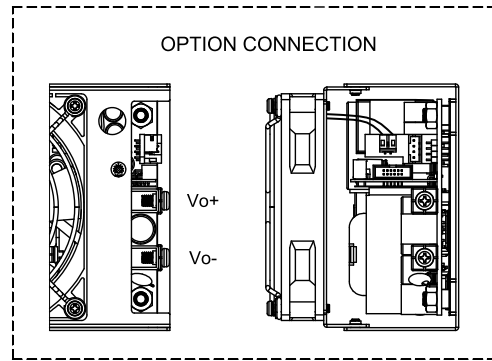
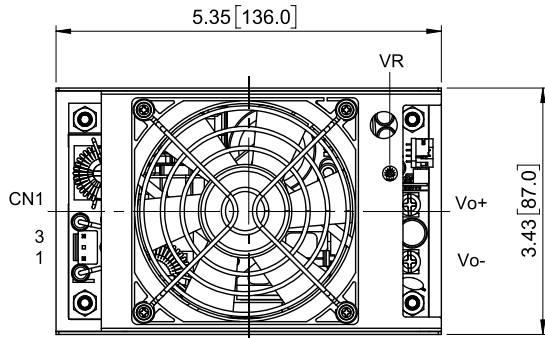

CFM600SXXXF

All Dimensions in Inches[mm]
 Tolerance Inches: x.xx=±0.03, x.xxx=±0.020
 Millimeters: x.x=±0.7, x.xx=±0.50

AC Input Connector(CN1):JST B2P3-VH or equivalent

Pin	Function	Mating Housing	Terminal
1	ACL	JST VHR-3N or equivalent	JST SVH-41T-P1.1 or equivalent
2	-		
3	ACN		

DC Output Connector(CN9):TKP P110I-04 or equivalent

Pin	Function	Mating Housing	Terminal
1	GND	JST PHR-4 or equivalent	JST SPH-002T-P0.5L or equivalent
2	+5VSB		
3	GND		
4	+12V-FAN		

DC Output Connector(CN3):Townes B304F-12RGF-104-LH or equivalent

Pin	Function	Mating Housing
1	NA	Samtec FFS0-06-01-N or equivalent
2	NA	
3	NA	
4	NA	
5	NA	
6	NA	
7	PS ON/OFF	
8	GND	
9	PG/PF	
10	NA	
11	Vsns-	
12	Vsns+	

DC Output Connector:KANG YANG PCB-58M4 or equivalent

Function	The screw locked torque
Vo-	M4 7kgf-cm
Vo+	

CINCON Electronics Co. Ltd.
 Add: 14F, No. 306, Sec.4, Hsin Yi Rd., Taipei, Taiwan
 Tel: 886-2-27086210
 Fax: 886-2-27029852
 E-mail: sales@cincon.com.tw
 Web: www.cincon.com

FORTEC

GROUP

Our company network supports you worldwide with offices in Germany, Austria, Switzerland, the UK and the USA. For more information please contact:

FORTEC

GROUP

FORTEC Elektronik AG | Augsburgener Straße 2b | 82110 Germering
+49 89 894450-0
info@fortecag.de | www.fortecag.de

FORTEC

INTEGRATED

FORTEC Integrated GmbH | Augsburgener Straße 2b | 82110 Germering
+49 89 894363-0
info@fortec-integrated.de | www.fortec-integrated.de

FORTEC

POWER

FORTEC Power GmbH | Lise-Meitner-Straße 3 | 64560 Riedstadt
+49 6158 8285-0
weborder@fortec-power.de | www.fortec-power.de

FORTEC

EGYPT

FORTEC Electronic Design and Solution Egypt SMLC | Linx Business Park
Unit B318 | Smart Village | Giza Governorate
info@fortec-integrated.de | www.fortec-integrated.de

Autronic Steuer- und Regeltechnik GmbH | Siemensstraße 17
74343 Sachsenheim
+49 7147 24-0
vertrieb@autronic.de | www.autronic.de

FORTEC

CZECH REPUBLIC

FORTEC Czech Republic s.r.o. | Přátelství 275 | 330 02 Dýšina
+49 89 894363-0
info@fortec.cz | www.fortec.cz

FORTEC

UNITED STATES

FORTEC United States, Corp. | 87 Raynor Avenue Unit 1 | Ronkonkoma
NY | 11779 | +1 631 5804360
info@fortec.us | www.fortec.us

FORTEC

SWITZERLAND

FORTEC Switzerland AG | Bahnhofstraße 3 | 5436 Würenlos
+41 44 7446111
info@fortec.ch | www.fortec.ch

FORTEC

UNITED KINGDOM

FORTEC Technology UK Ltd. | Osprey House | 1 Osprey Court
Hinchingsbrooke Business Park | Huntingdon | Cambridgeshire | PE29 6FN
+44 1480 411600
info@fortec.uk | www.fortec.uk