

Datasheet

CDCP-40W

FORTEC
UNITED STATES

FORTEC
INTEGRATED

FORTEC
UNITED KINGDOM

The information contained in this document has been carefully researched and is, to the best of our knowledge, accurate. However, we assume no liability for any product failures or damages, immediate or consequential, resulting from the use of the information provided herein. Our products are not intended for use in systems in which failures of product could result in personal injury. All trademarks mentioned herein are property of their respective owners. All specifications are subject to change without notice.

PINNACLE™ 40W SERIES

Constant Current | Tri-Mode Dimming



Tri-Mode Dimming of Constant Current LED Drivers were designed for input voltages 120VAC through 277VAC and maintains a fully isolated output.

Compatible with Triac (forward-phase or leading-edge), ELV (reverse-phase or trailing-edge) and 0-10V dimmers.

We've built-in automated short circuit, over voltage, over current and over temperature protections. Each driver undergoes rigorous testing and a full load burn in.

Features



Tri-mode Dimmable



UL Class P Power Supply



IP65 Rated Case with Silicone-based Potting



90°C Maximum Case Temperature



Worldwide Safety Approvals



5 Year Warranty (Minimum at 70°C Tc)

Model Information

Part Number	Input Voltage (Vac)	Output Power (w)	Output Current (mA)	Output Voltage (Vdc)	Dimming Method
CDCP-40-0900-43	120-277	40	900	43	TRIAC, ELV & 0-10 V
CDCP-40-1400-28	120-277	40	1400	28	TRIAC, ELV & 0-10 V
CDCP-40-0700-60	120-277	40	700	60	TRIAC, ELV & 0-10 V
CDCP-40-0900-42	120-277	40	900	42	TRIAC, ELV & 0-10 V

Input

Voltage Range:	120 - 277V
Frequency Range:	47/60HZ
Input Current:	1.05 A @ 120 Vac 0.58 A @ 230 Vac 0.48 A @ 277 Vac
Power Factor (PF):	>0.9
Inrush Current:	5.31A/120VAC 11.3A/230VAC
Leakage Current:	400 uA @ 120 Vac 800 uA @ 230 Vac 920 uA @ 277 Vac
Efficiency:	>92%
THD:	<20%

Output

Output Voltage	6-56V Current Dependent
Output Current	180-1750mA Voltage Dependent
Output Voltage Regulation	± 5.0%
Output Voltage Overshoot	<10%
Setup, Rise, Hold Up time	<1s

Dimming Control

+Dim Signal, -Dim Signal	CDMP 40W SERIES operate only with 0-10V dimmers . The method to dim the output current of the driver is done via the +Dim/-Dim Signal pins. The +Dim/-Dim signal pins can be used to adjust the output setting via a standard commercial wall dimmer, an external control voltage source (0 to 10Vdc), or a variable resistor when using the recommended number of LEDs. The dimming input permits 1% to 100% dimming.
Dimming Range	1% -100%

Protection

Over Load Protection:	105-150% Protection type: Auto Restore
Over Voltage Protection:	105-130% Protection type: Auto Restore
Short Circuit Protection:	Protection type: Auto Restore
Warranty:	5 Years at Tc 70°C

Environment

Working Temperature	-20°C - +50°C
Working Humidity	20% - 90%RH
Storage Temperature	-40°C - +85°C
HSF requirement	Reach, RoHS

Safety and Electromagnetic Compatibility

Certifications:	UL, cUL, CE, FCC
Safety Standards:	UL8750 listed Class P; CAN/CSA C22.2 No. 250.13-14 LED equipment for lighting applications; EN61347-2-13 electronic control gear for LED Modules
EMI:	Compliant with FCC CFR Title 47 Part 15 Class B at 120 Vac & Class A at 277 Vac; Compliant with EN55015 (EMC compliance) at 230 Vac
EMS:	EN 61000-4-2; Performance Criteria B EN 61000-4-5; Performance Criteria C

Dimensions & Weight

Length:	9.6cm / 3.78in
Width:	4.3cm / 1.69in
Height:	2.8cm / 1.1in
Weight:	147.5g

Spec Drawing

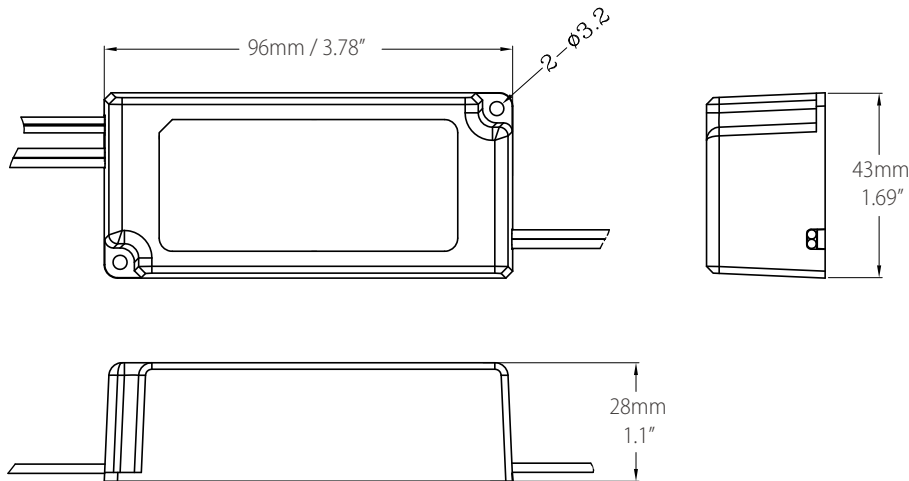

Label

YINGJIAO[®]
Model: CDCP-40-1400-27
 Dimmable Constant Current LED Driver
 Class II
 Suitable for Dry or Damp Locations
 Suitable with 120Vac TRIAC Dimmers

AC INPUT:
 120-277V-0.5A
 50/60Hz
 PF ≥0.9
 THD ≥20%

N: White
 L: Black

DC OUTPUT:
 Regulated Current: 1400mA \equiv
 Maximum Power: 37.8W
 Voltage Range: 20-27 Vdc
 No Load voltage: 35Vdc

RED: +
 BLACK: -
 DIM: + Purple
 DIM: - Pink
 (For 0-10v dimming)
 Made in China

● tc



SELV LVLE

Packing

Carton Size	44 x 27 x 22 cm
	17.32 x 10.63 x 8.66 in
Master Carton Quantities	100pcs / Carton

Feature Curves

1. PF Curve

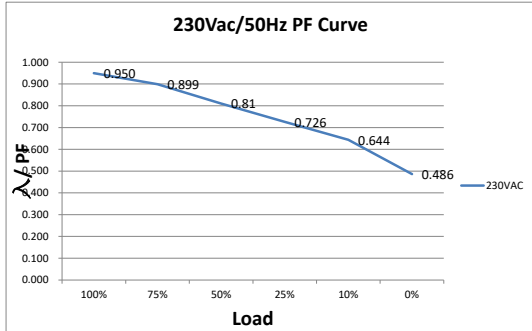
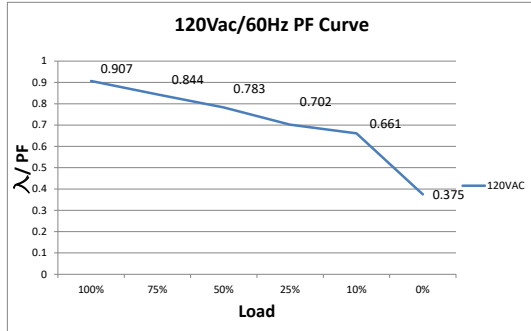

2. Efficiency Curve

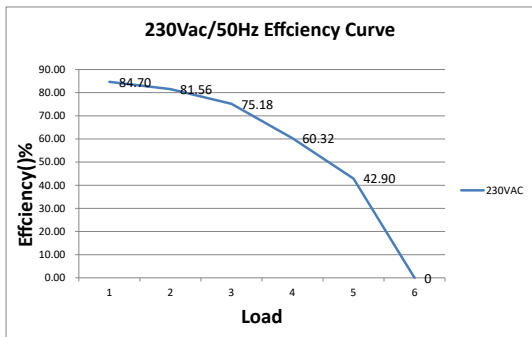
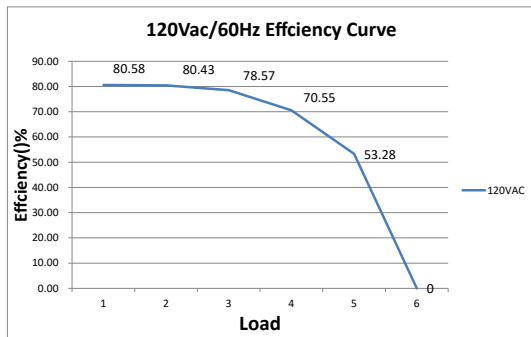

3. Dimming Curve

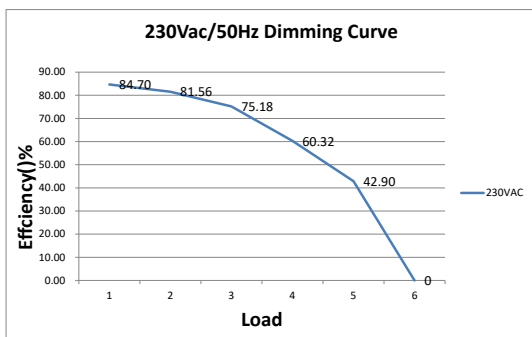
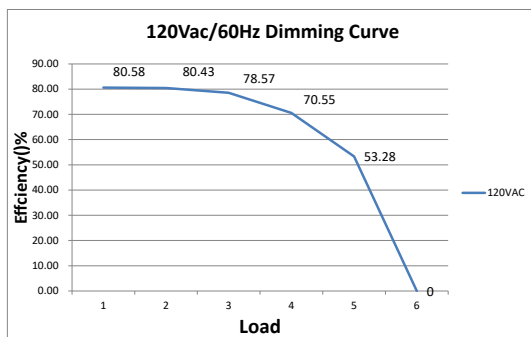

FORTEC

GROUP

Our company network supports you worldwide with offices in Germany, Austria, Switzerland, the UK and the USA. For more information please contact:

FORTEC

GROUP

FORTEC Elektronik AG | Augsburgener Straße 2b | 82110 Germering
+49 89 894450-0
info@fortecag.de | www.fortecag.de

FORTEC

INTEGRATED

FORTEC Integrated GmbH | Augsburgener Straße 2b | 82110 Germering
+49 89 894363-0
info@fortec-integrated.de | www.fortec-integrated.de

FORTEC

POWER

FORTEC Power GmbH | Lise-Meitner-Straße 3 | 64560 Riedstadt
+49 6158 8285-0
weborder@fortec-power.de | www.fortec-power.de

FORTEC

EGYPT

FORTEC Electronic Design and Solution Egypt SMLC | Linx Business Park
Unit B318 | Smart Village | Giza Governorate
info@fortec-integrated.de | www.fortec-integrated.de

Autronic Steuer- und Regeltechnik GmbH | Siemensstraße 17
74343 Sachsenheim
+49 7147 24-0
vertrieb@autronic.de | www.autronic.de

FORTEC

CZECH REPUBLIC

FORTEC Czech Republic s.r.o. | Přátelství 275 | 330 02 Dýšina
+49 89 894363-0
info@fortec.cz | www.fortec.cz

FORTEC

UNITED STATES

FORTEC United States, Corp. | 87 Raynor Avenue Unit 1 | Ronkonkoma
NY | 11779 | +1 631 5804360
info@fortec.us | www.fortec.us

FORTEC

SWITZERLAND

FORTEC Switzerland AG | Bahnhofstraße 3 | 5436 Würenlos
+41 44 7446111
info@fortec.ch | www.fortec.ch

FORTEC

UNITED KINGDOM

FORTEC Technology UK Ltd. | Osprey House | 1 Osprey Court
Hinchingsbrooke Business Park | Huntingdon | Cambridgeshire | PE29 6FN
+44 1480 411600
info@fortec.uk | www.fortec.uk