

YSD100L SERIES 100W









yingjiao's slimline power family are designed with slim plastic housing and for full range AC input from 90VAC to 264VAC.

The series are single phase Psu, providing DC Ok relay contact and adjustable DC output voltage. They have high efficiency and operate in wide temperature range.

The series can widely used for industrial automation & control systems, varied equipments etc.



Features

-  universal AC Input/ Full Range
-  DC oK Relay Contact
-  Protection: Short Circuit/overload/ over voltage
-  Three years warranty
-  Installation on DIN Rail TS-35/7.5 & 15
-  Built-in Active PFC Function
-  DC output voltage Adjustable

Model Information

yingjiao Part number	DC VOLTAGE	RATED CURRENT	RATED POWER
YSD100L-1207500	12V	7.5A	90W
YSD100L-2404000	24V	4A	96W
YSD100L-4802000	48V	2A	96W

Input

VOLTAGE RANGE	90-264VAC/127-370VDC	
FREQUENCY RANGE	47~63Hz	
INRUSH CURRENT	30A/115VAC	COld start
	60A/230VAC	COld start
AC CURRENT	1.3A/115VAC 0.8A/230VAC	
LEAKAGE CURRENT	<1mA/240VAC	
EFFICIENCY	83%	YSD100L-1207500
	86%	YSD100L-2404000
	87%	YSD100L-4802000

Output

RIPPLE & NOISE	120mVp-p	YSD100L-1207500
	150mVp-p	YSD100L-2404000
	200mVp-p	YSD100L-4802000
VOLTAGE ADJ. RANGE	12~15V	YSD100L-1207500
	24~30V	YSD100L-2404000
	48~56V	YSD100L-4802000

output

VOLTAGE TOLERANCE	±2.0%
LINE REGULATION	±1.0%
LOAD REGULATION	±1.0%
SETUP, RISE TIME	3000ms, 50ms/230VAC at full load 3000ms, 50ms/115VAC at full load
HOLD UP TIME (TYP.)	50ms/230VAC at full load 20ms/115VAC at full load

protection

OVER LOAD	105%-150% Rated Output Power Protection type : Hiccup mode, recovers automatically after fault condition is removed.
OVERVOLTAGE	12V:15.6 ~ 18V 24V:31.2 ~ 36V 48V:57.6 ~ 64.8V Protection type : Shutdown o/p voltage, re-power on to recover
OVERTEMPERATURE	Protection type : Shutdown o/p voltage, re-power on to recover

Environment

OPERATING TEMPERATURE	-10 °C to 60 °C (Refer to "Derating Curve")
STORAGE TEMP	-40 °C to 85 °C
STORAGE HUMIDITY	10 ~ 95% RH
WORKING HUMIDITY	20% ~ 90% RH Non-Condensing

SAFETY & EMC

SAFETY REGULATIONS	UL508, BS/EN62368-1 approved
WITHSTAND VOLTAGE	I/P-O/P:3KVAC I/P-FG:2KVAC O/P-FG:0.5KVAC
ISOLATION RESISTANCE	I/P-O/P, I/P-FG, O/P-FG:100M Ohms / 500VDC / 25°C / 70% RH
EMC EMISSION	BS EN/EN 55032 class B, BS EN/EN IEC 61000-3-2,3
EMC IMMUNITY	BS EN/EN 61000-4-2,3,4,5,6,8,11

Dimensions & weight

Length:	100mm / 3.94in
width:	55mm / 2.17in
Height:	92mm / 3.62in
weight:	400g

packing

carton size:	42.5 X 32 X 24 CM 21.26 X 16.73 X 9.45 in
Master carton Quantities:	40pcs / Carton

Dimensions and Installation

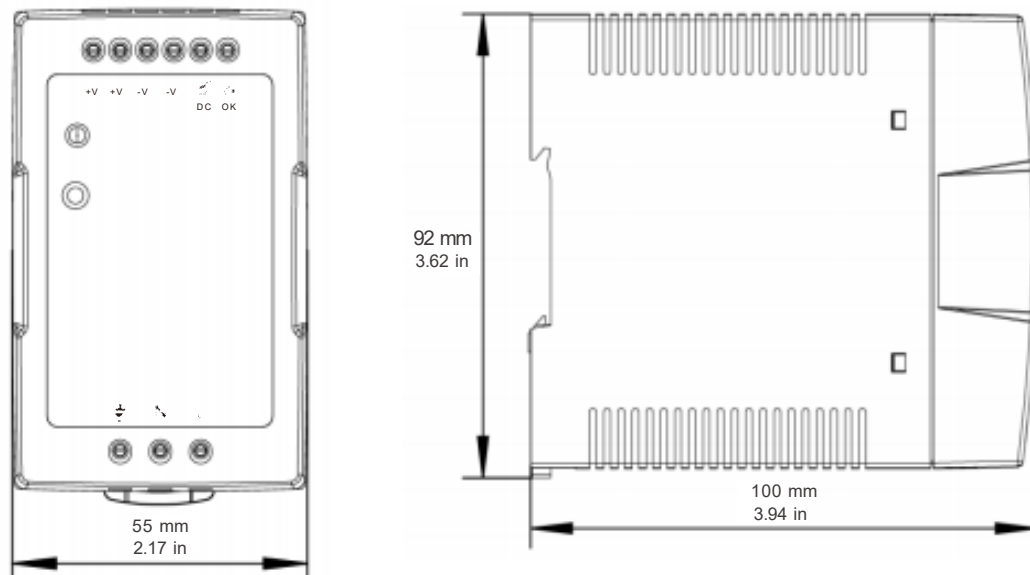

Functional Diagram

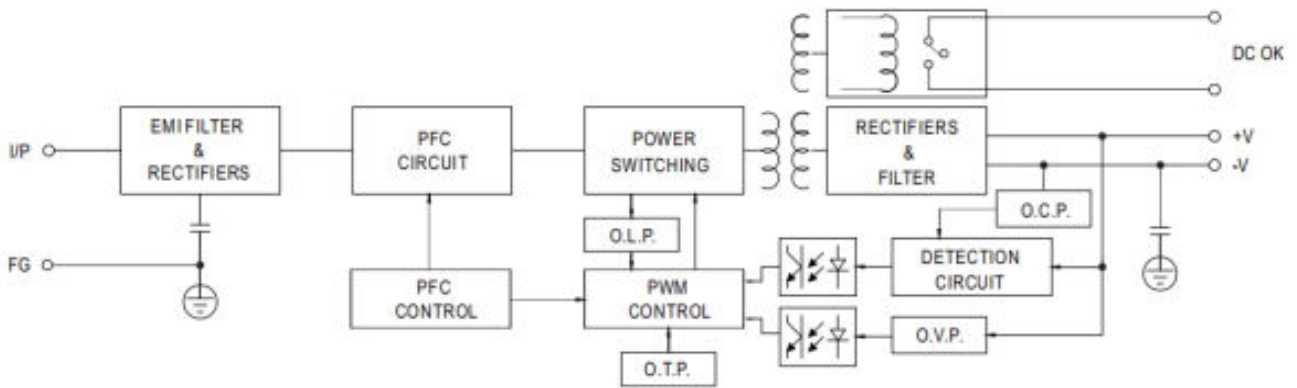

APPLication Of DC OK Active signal

Contact Close	PSU turns on / DC OK.
Contact Open	PSU turns off / DC Fail.
Contact Ratings (max.)	30V/1A resistive load.

Deduction Curve and TemPerature

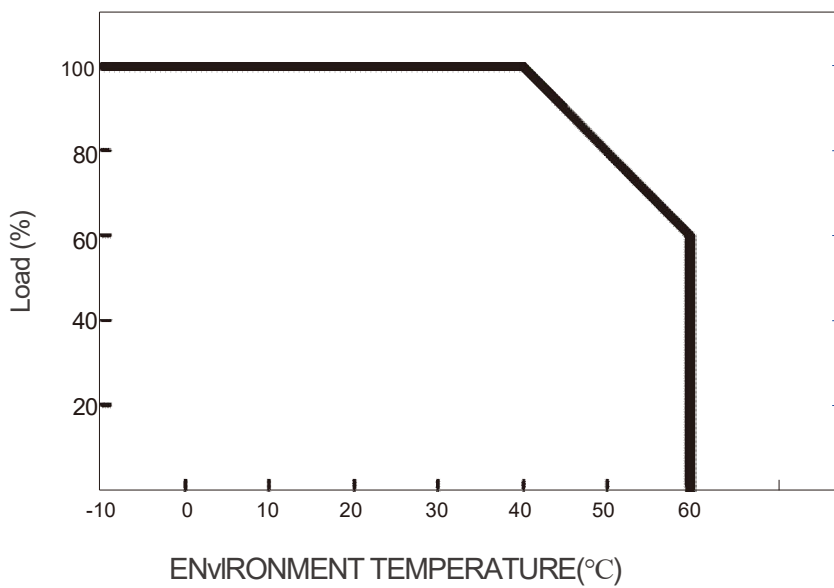

Minus Output and Input Voltage Curves

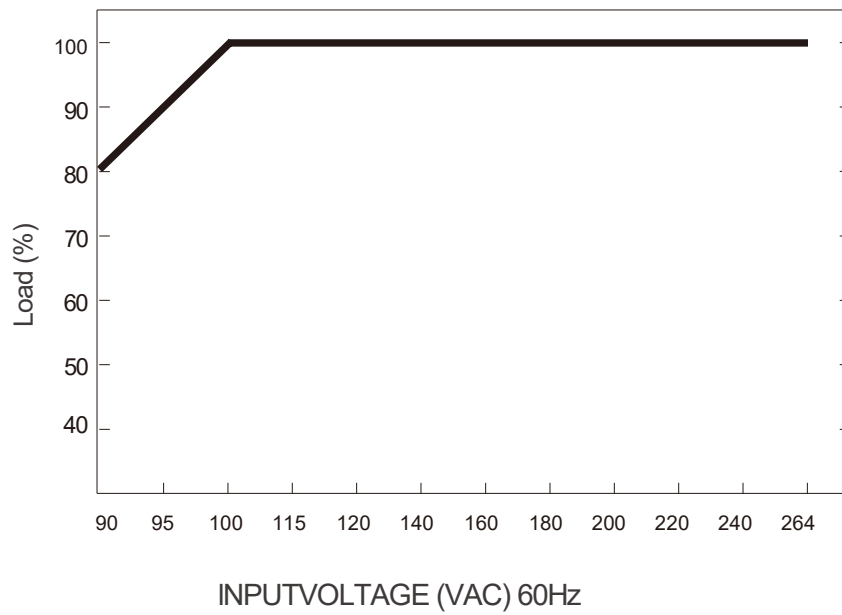

Available from:

FORTEC
UNITED KINGDOM

Osprey House
1 Osprey Court
Hinchingsbrooke
Business Park
Huntingdon
PE29 6FN

www.fortec.uk
info@fortec.uk
Tel: 01480 411600