

Datasheet

Tianma

TM030LDHT10-00

TI-60-014

The information contained in this document has been carefully researched and is, to the best of our knowledge, accurate. However, we assume no liability for any product failures or damages, immediate or consequential, resulting from the use of the information provided herein. Our products are not intended for use in systems in which failures of product could result in personal injury. All trademarks mentioned herein are property of their respective owners. All specifications are subject to change without notice.

MODEL NO : TM030LDHT10**MODEL VERSION:** 00**SPEC VERSION :** Ver 2.0**ISSUED DATE:** 2018-3-12

- Preliminary Specification
 Final Product Specification

Customer : Garmin

| Approved by | Notes |
|-------------|-------|
| | |

TIANMA Confirmed :

| Prepared by | Checked by | Approved by |
|---------------|---------------|-------------|
| Tiantian Zhao | Xiaoxing Ding | Kevin Kim |

Table of Contents

| | |
|--|----|
| Table of Contents | 2 |
| Record of Revision..... | 3 |
| 1 General Specifications..... | 4 |
| 2 Input/Output Terminals | 5 |
| 3 Absolute Maximum Ratings..... | 7 |
| 4 Electrical Characteristics | 8 |
| 5 Timing Chart..... | 10 |
| 6 Optical Characteristics | 15 |
| 7 Environmental / Reliability Test..... | 20 |
| 8 Mechanical Drawing | 21 |
| 9 Packing Drawing | 22 |
| 10 Precautions for Use of LCD Modules..... | 23 |
| 11 IIS..... | 25 |

1 General Specifications

| Feature | | Spec |
|-----------------------------------|--------------------------------|---|
| Display Spec. | Size | 3,0" |
| | Resolution | 240(RGB)x400 |
| | Technology Type | a-si TFT |
| | Pixel Configuration | RGB Vertical Stripe |
| | Pixel pitch(mm) | 0.162x0.162 |
| | Display Mode | ECB Mode, Transflective |
| | Surface Treatment | Top POL: HC Type($\frac{1}{4} \lambda$ haze63%) Bottom POL: clear |
| | Viewing Direction | 5 o'clock |
| | Gray Scale Inversion Direction | 11 o'clock |
| Mechanical Characteristics | LCM (W x H x D) (mm) | 76.65x46.48x2.97 |
| | Active Area(mm) | 38.88x64.8 |
| | With /Without TSP | Without TP |
| | Matching Connection Type | Molex 55909-0574 |
| | LED Numbers | 6LEDs |
| | Weight (g) | 21.2g |
| Electrical Characteristics | Interface | CPU 16 bits |
| | Color Depth | 65K |
| | Driver IC | HX8352-B00 |

Note 1: Viewing direction for best image quality is different from TFT definition. There is a 180 degree shift.

Note 2: Requirements on Environmental Protection: Q/S0002

Note 3: LCM weight tolerance: $\pm 5\%$

Note 4: Polarizer absorption angle as follow:

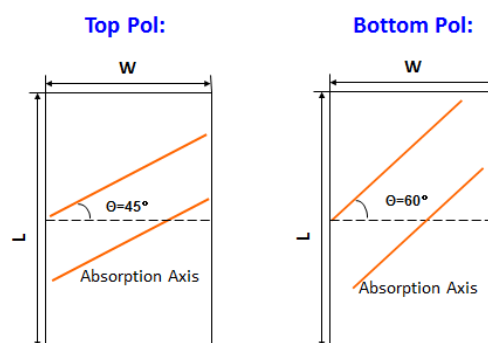

Top view from **Protective Film** side

2 Input/Output Terminals

Matched connector: Molex 55909-0574

| Pin No. | Symbol | I/O | Function | Remark |
|---------|--------|-----|--|--------|
| 1 | ID2 | O | Identification(pull VDD 1.8V internally) | |
| 2 | GND | P | Ground | |
| 3 | GND | P | Ground | |
| 4 | RESB | I | System reset | |
| 5 | NC | - | Not connect | |
| 6 | DB15 | I | Data signal | |
| 7 | DB14 | I | Data signal | |
| 8 | DB13 | I | Data signal | |
| 9 | DB12 | I | Data signal | |
| 10 | DB11 | I | Data signal | |
| 11 | DB10 | I | Data signal | |
| 12 | DB9 | I | Data signal | |
| 13 | DB8 | I | Data signal | |
| 14 | NC | - | Not connect | |
| 15 | DB7 | I | Data signal | |
| 16 | DB6 | I | Data signal | |
| 17 | DB5 | I | Data signal | |
| 18 | DB4 | I | Data signal | |
| 19 | DB3 | I | Data signal | |
| 20 | DB2 | I | Data signal | |
| 21 | DB1 | I | Data signal | |
| 22 | DB0 | I | Data signal | |
| 23 | NC | - | Not connect | |
| 24 | LED-K | P | Power supply for LED(Cathode) | |
| 25 | NC | - | Not connect | |
| 26 | LED-A | P | Power supply for LED of full(Anode) | |
| 27 | GND | P | Ground(pull low internally) | |
| 28 | GND | P | Ground | |
| 29 | ID1 | O | Identification(pull VDD 1.8V internally) | |

| | | | | |
|----|-----|---|-------------------------------------|-------|
| 30 | TE | O | Tearing effect output | |
| 31 | GND | P | Ground | |
| 32 | GND | P | Ground | |
| 33 | GND | P | Ground | |
| 34 | GND | P | Ground | |
| 35 | GND | P | Ground | |
| 36 | GND | P | Ground | |
| 37 | NC | - | Not connect | |
| 38 | VDD | P | Voltage input pin for logic I/O | |
| 39 | VCI | P | Booster input voltage pin | |
| 40 | IM0 | I | Interface mode select pin | Note2 |
| 41 | IM1 | I | Interface mode select pin | Note2 |
| 42 | IM2 | I | Interface mode select pin | Note2 |
| 43 | GND | P | Ground | |
| 44 | GND | P | Ground | |
| 45 | GND | P | Ground | |
| 46 | NC | - | Not connect | |
| 47 | RD | I | Read control input pin | |
| 48 | WR | I | Write control input pin | |
| 49 | RS | I | Resister select input pin | |
| 50 | CS | I | Chip select pin of serial interface | |
| 51 | NC | - | Not connect | |

Note1: Please add the FPC connector type and matched one if necessary .

Note2: IM2: IM1: IM0=010 CPU 16bits

IM2: IM1: IM0=011 CPU 8bits

3 Absolute Maximum Ratings

GND=0V

| Item | Symbol | MIN | MAX | Unit | Remark |
|----------------------------|-----------------|------|-----|------------------|------------------|
| Power Voltage | VCC | -0.3 | 4.6 | V | Note1 |
| Input voltage | V _{IN} | -0.3 | 4.6 | V | |
| Operating Temperature | Top | -20 | 70 | °C | |
| Storage Temperature | Tst | -30 | 85 | °C | |
| Relative Humidity Note2 | RH | -- | ≤95 | % | Ta ≤ 40°C |
| | | -- | ≤85 | % | 40°C < Ta ≤ 50°C |
| | | -- | ≤55 | % | 50°C < Ta ≤ 60°C |
| | | -- | ≤36 | % | 60°C < Ta ≤ 70°C |
| | | -- | ≤24 | % | 70°C < Ta ≤ 80°C |
| Absolute Humidity | AH | -- | ≤70 | g/m ³ | Ta > 70°C |

Table 3 Absolute Maximum Ratings

Note1: Input voltage include R0~R5, G0~G5, B0~B5, Dotclk, Hsync, Vsync, Enable, R/L, U/D.

Note2: Ta means the ambient temperature.

It is necessary to limit the relative humidity to the specified temperature range.

Condensation on the module is not allowed.

4 Electrical Characteristics

4.1 LCD Module

GND=0V, Ta=25°C

| Item | Symbol | MIN | TYP | MAX | Unit | Remark |
|-----------------------|------------|-----------|-----|-----------|------|--------|
| Logic Supply Voltage | IOVCC | 1.65 | 1.8 | 3.3 | V | |
| Analog Supply Voltage | VCC | 2.5 | 3.0 | 3.3 | V | |
| Input Signal Voltage | High Level | 0.7 IOVCC | - | IOVCC | V | |
| | Low Level | - | - | 0.3 IOVCC | V | |
| Output Signal Voltage | High Level | 0.8 IOVCC | - | - | V | |
| | Low Level | - | - | 0.2 IOVCC | V | |

Table 4.1 LCD module electrical characteristics

4.2 Backlight Unit

Ta=25°C

| Item | Symbol | MIN | TYP | MAX | Unit | Remark |
|-----------------------------|------------------|-----|-------|-----|------|---------|
| Forward Current | I_F | - | 20 | - | mA | One LED |
| Forward Voltage | V_F | 2.6 | 2.9 | 3.2 | V | One LED |
| Backlight Power Consumption | W_{BL} | - | 348 | - | mW | 6LEDs |
| Lifetime | T | - | 20000 | - | Hr | One LED |
| WLED part number | Nichia NSSW 306D | | | | | |

Table 4.2.1 backlight unit electrical characteristics

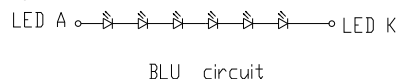

Figure 4.2.1 LED backlight circuit

4.3 Block Diagram

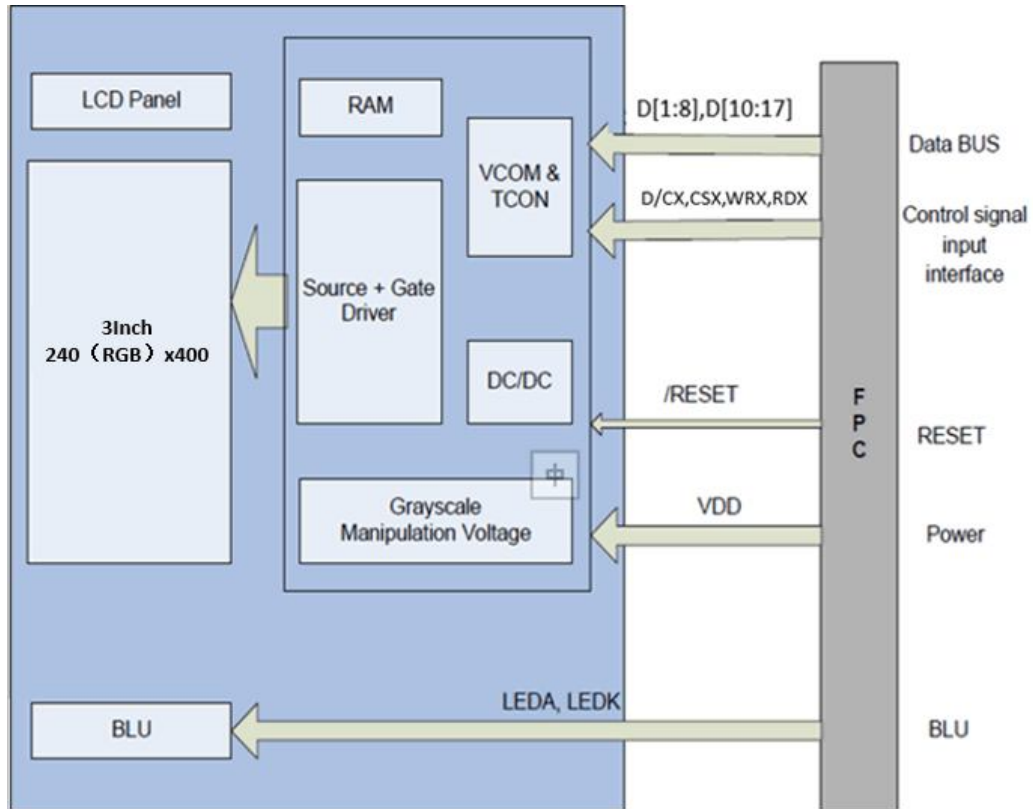
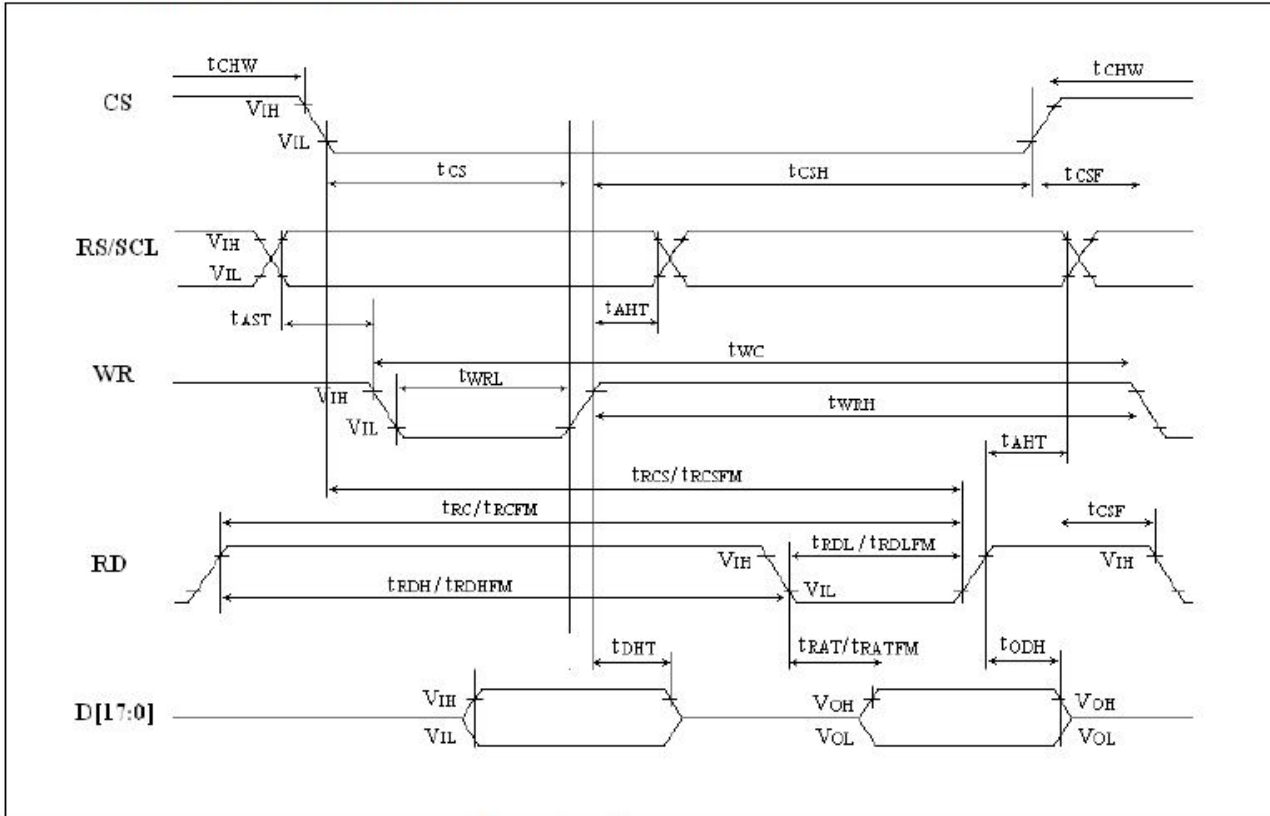

Figure 4.3 LCD module diagram

5 Timing Chart

5.1 AC Characteristics

5.1.1 CPU Interface Characteristics



CPU Interface Characteristics
Table 5.1 AC Characteristics

5.2 CPU Interface Input Timing parameters
Normal Write Mode (IOVCC=1.65~3.3V, VCC=2.3~3.3V)

| Signal | Symbol | Parameter | Spec. | | | Description |
|---------|-------------|-----------------------------------|-------|--------|------|---|
| | | | Min. | Max. | Unit | |
| RS/SCL | t_{AST} | Address setup time | 10 | - | ns | - |
| | t_{AHT} | Address hold time(Write/Read) | 10 | - | ns | |
| CS | t_{CHW} | Chip select "H" pulse width | 0 | - | ns | - |
| | t_{CS} | Chip select setup time (Write) | 35 | - | | |
| | t_{RCSFM} | Chip select setup time | 355 | - | | |
| | t_{CSF} | Chip select wait time(Write/Read) | 10 | - | | |
| | t_{CSH} | Chip select hold time | 10 | - | | |
| WR | t_{WC} | Write cycle | 100 | - | ns | - |
| | | | 33(5) | - | ns | |
| | t_{WRH} | Control pulse "H" duration | 15 | - | ns | |
| | t_{WRL} | Control pulse "L" duration | 15 | - | ns | |
| RD | t_{RC} | Read cycle | 450 | - | ns | When read from GRAM |
| | t_{RDH} | Control pulse "H" duration | 90 | - | | |
| | t_{RDL} | Control pulse "L" duration | 355 | - | | |
| D[17:0] | t_{DST} | Data setup time | 15 | - | ns | For maximum $C_L=30pF$ For minimum $C_L=8pF$ |
| | t_{DHT} | Data hold time | 10 | - | | |
| | t_{RATFM} | Read access time | - | 340(4) | | |
| | t_{ODH} | Output disable time | 20(4) | 80(4) | | |

CPU Interface Timing Parameters
Table 5.2 CPU Input Timing Parameters

5.3 CPU Interface Register write/read timing

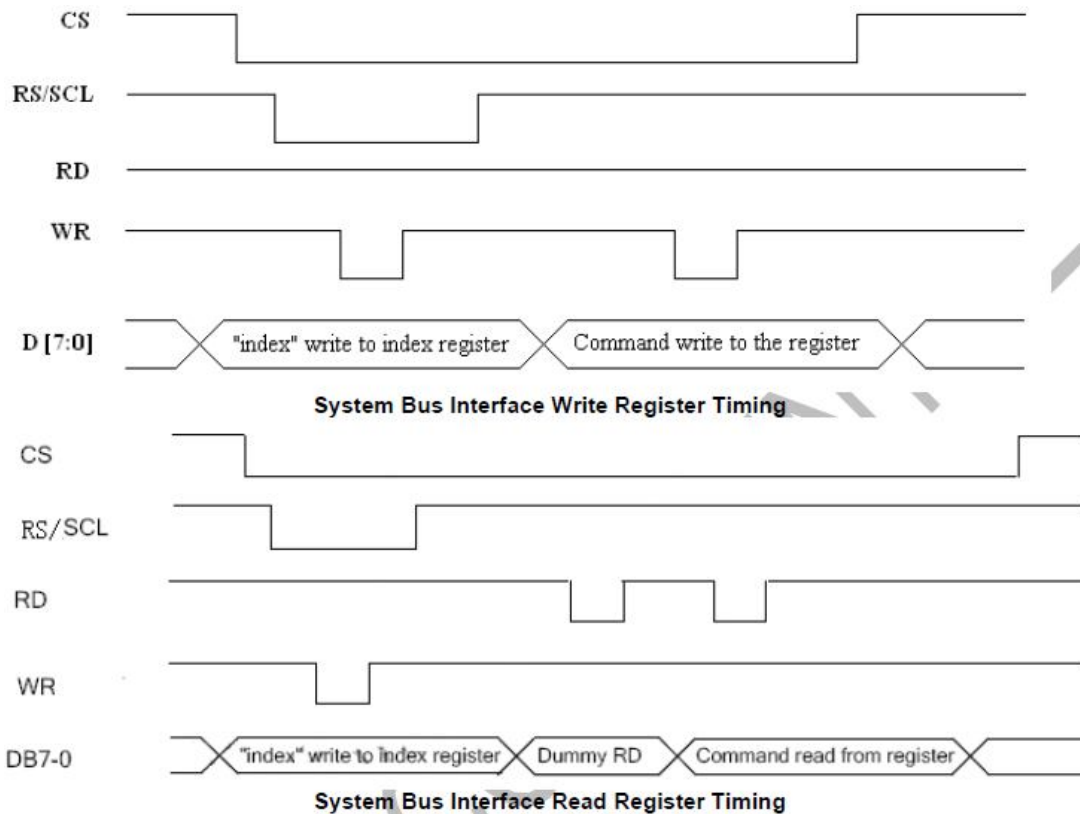
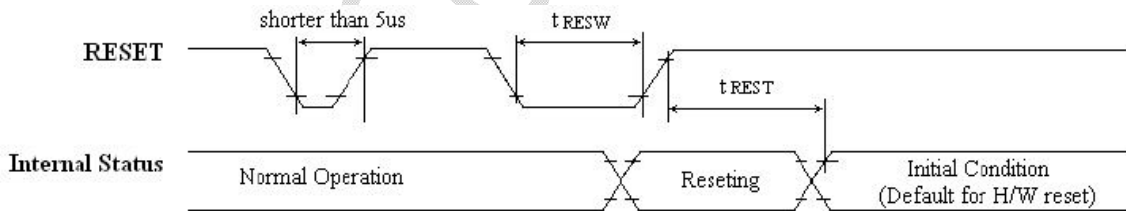

Figure 5.3 CPU Interface Register write/read timing

5.4 Reset timing Characteristics



Reset timing

Reset input timing

| Symbol | Parameter | Related Pins | Spec. | | | Note | Unit |
|------------|-----------------------|--------------|-------|------|------|--|------|
| | | | Min. | Typ. | Max. | | |
| t_{RESW} | Reset low pulse width | RESET | 10 | - | - | - | us |
| t_{REST} | Reset complete time | - | - | - | 5 | When reset applied during "Sleep In mode" | ms |
| | | - | - | - | 120 | When reset applied during "Sleep Out mode" | ms |

Figure 5.4 Reset Input Timing

5.5 POWER ON/OFF SEQUENCE

5.5.1 Power on Sequence

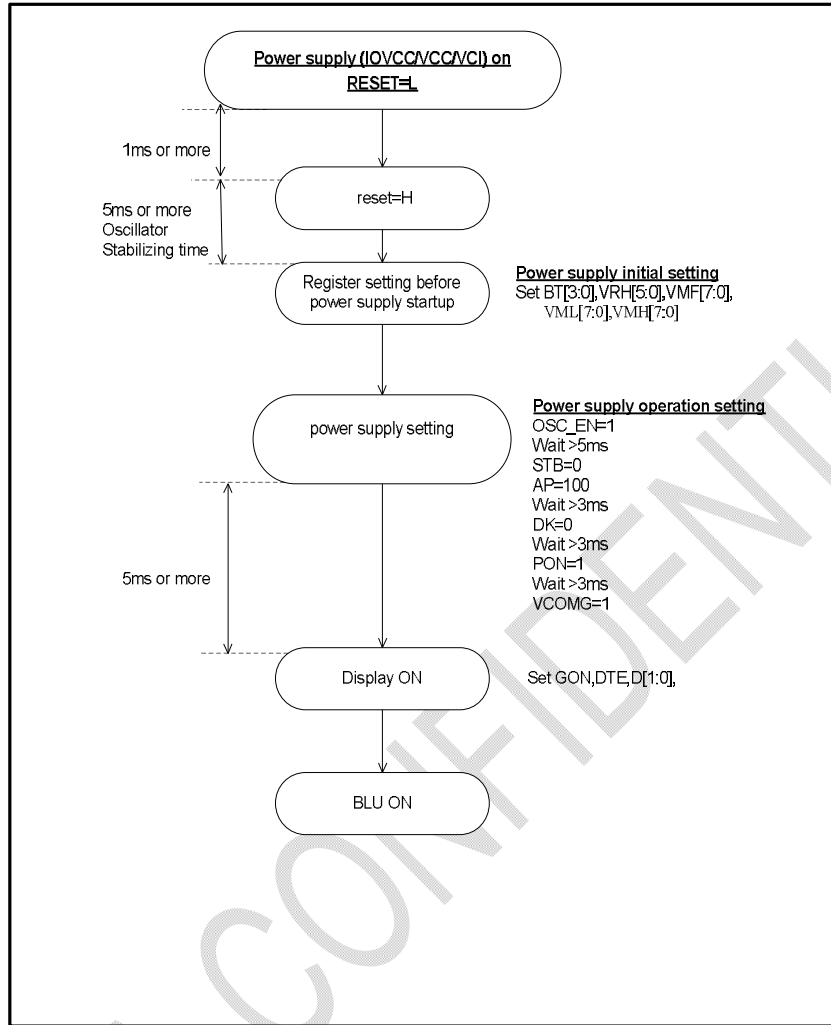

5.5.2 Power off Sequence

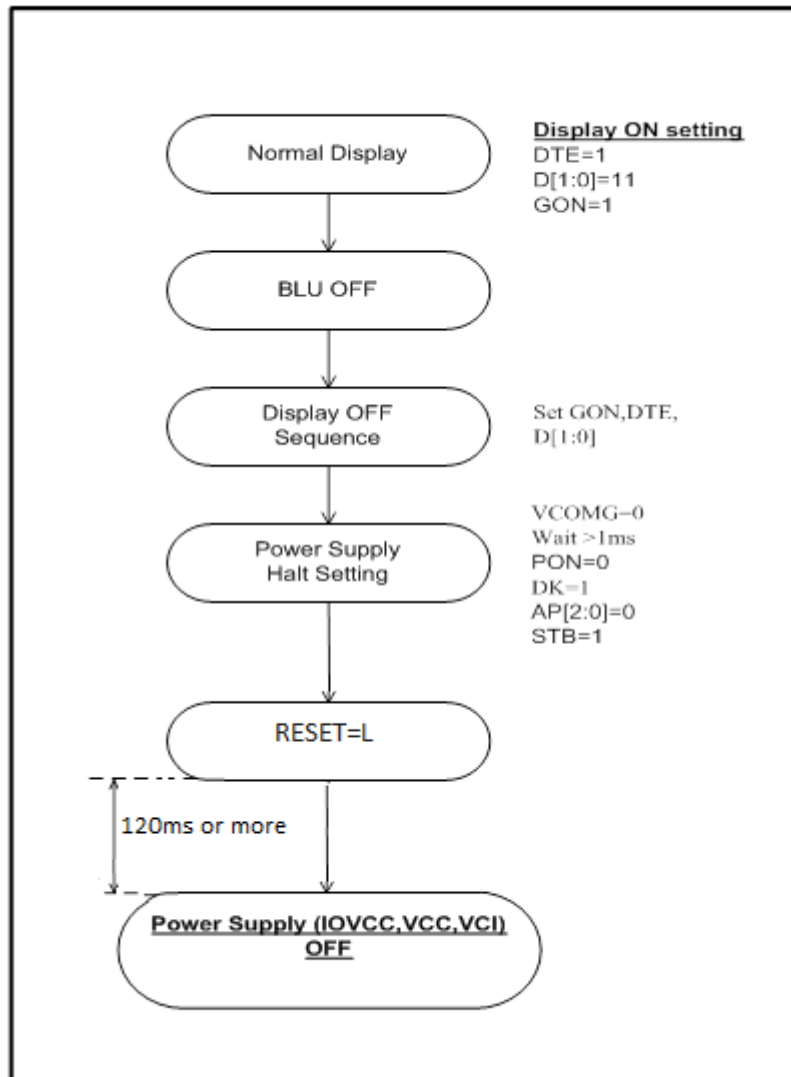

6 Optical Characteristics

6.1 Driving the backlight condition(Transmissive mode)

| Item | Symbol | Condition | Min | Typ | Max | Unit | Remark |
|----------------|------------------|------------------|-----|-------|-------|-------------------|----------|
| View Angles | θT | CR \geq 10 | 35 | 45 | - | Degree | Note2,3 |
| | θB | | 30 | 40 | - | | |
| | θL | | 35 | 45 | - | | |
| | θR | | 30 | 40 | - | | |
| Contrast Ratio | CR | $\theta=0^\circ$ | 60 | 80 | 120 | | Note 3 |
| Response Time | T _{ON} | 25°C | 20 | 30 | 50 | ms | Note 4 |
| | T _{OFF} | | | | | | |
| Chromaticity | White | Backlight is on | x | 0.280 | 0.310 | 0.340 | Note 1,5 |
| | | | y | 0.301 | 0.331 | 0.361 | |
| | Red | | x | 0.473 | 0.503 | 0.533 | Note 1,5 |
| | | | y | 0.315 | 0.345 | 0.375 | |
| | Green | | x | 0.280 | 0.310 | 0.340 | Note 1,5 |
| | | | y | 0.501 | 0.531 | 0.561 | |
| | Blue | | x | 0.132 | 0.162 | 0.192 | Note 1,5 |
| | | | y | 0.107 | 0.137 | 0.167 | |
| Uniformity | U | | 70% | 80% | | % | Note 6 |
| NTSC | | | 28 | 33 | 38 | % | Note 5 |
| Luminance | L | | 130 | 150 | | cd/m ² | Note 7 |
| Flicker | | | | | -25 | dB | |
| Crosstalk | | | | | 3% | | |

Test Conditions:

1. I_F= 20mA, and the ambient temperature is 25°C.
2. The test systems refer to Note 1 and Note 2.

6.2 Not Driving the backlight condition(Reflective mode)

| Item | Symbol | Condition | Min | Typ | Max | Unit | Remark |
|------------------|------------------|------------------|------|-------|-------|--------|----------|
| View Angles | θT | CR \geq 5 | 25 | 35 | - | Degree | Note2,3 |
| | θB | | 25 | 35 | - | | |
| | θL | | 20 | 30 | - | | |
| | θR | | 20 | 30 | - | | |
| Contrast Ratio | CR | $\theta=0^\circ$ | 8 | 10 | - | | Note 3 |
| Response Time | T _{ON} | 25°C | 10 | 20 | 40 | ms | Note 4 |
| | T _{OFF} | | | | | | |
| Chromaticity | White | Backlight is off | x | 0.301 | 0.331 | 0.361 | Note 1,5 |
| | | | y | 0.33 | 0.360 | 0.39 | |
| | Red | | x | 0.388 | 0.418 | 0.448 | Note 1,5 |
| | | | y | 0.327 | 0.357 | 0.387 | |
| | Green | | x | 0.3 | 0.330 | 0.36 | Note 1,5 |
| | | | y | 0.388 | 0.418 | 0.448 | |
| | Blue | | x | 0.18 | 0.210 | 0.24 | Note 1,5 |
| | | | y | 0.213 | 0.243 | 0.273 | |
| Reflection ratio | U | | 6.55 | 7.27 | 7.63 | % | |
| NTSC | | | 6.2 | 7.35 | 8.5 | % | |
| Flicker | | | | | -30 | dB | |

Test Conditions:

1. I_F= 20 mA, and the ambient temperature is 25°C.
2. The test systems refer to Note 1 and Note 2.
3. Flicker pattern(pixel inversion: Line inversion)



Flicker for line inversion

Note 1: Definition of optical measurement system.

1. Transmissive mode: The optical characteristics should be measured in dark room. After 5 Minutes operation, the optical properties are measured at the center point of the LCD screen. All input terminals LCD panel must be ground when measuring the center area of the panel.

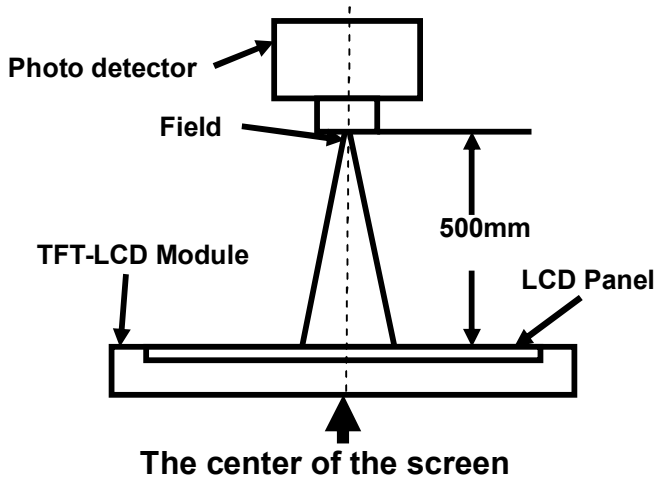

| Item | Photo detector | Field |
|----------------|----------------|-------|
| Contrast Ratio | SR-3A | 1° |
| Luminance | | |
| Chromaticity | | |
| Lum Uniformity | | |
| Response Time | LCD-5200 | / |
| Flicker | CA-310 | / |

2. Reflective mode

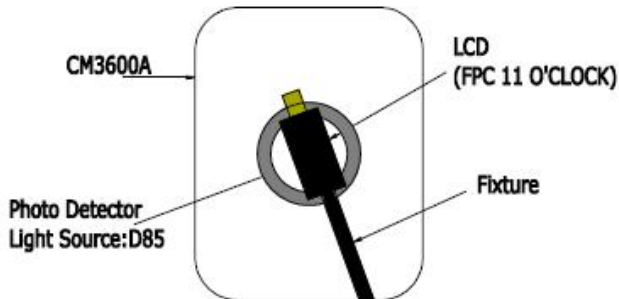

| Item | Photo detector | Field |
|------------------|----------------|-------|
| Chromaticity | CM-3600A | |
| Reflective Ratio | | |
| Contrast Ratio | | |
| Viewing angle | LCD-5200 | |
| Flicker | | |

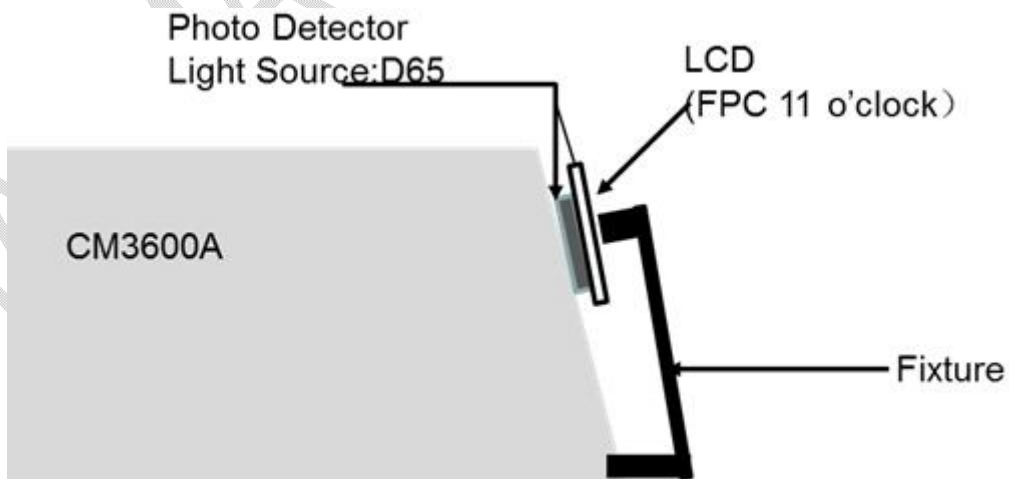

Note 2: Definition of viewing angle range and measurement system.

viewing angle is measured at the center point of the LCD by CONOSCOPE(ergo-80).

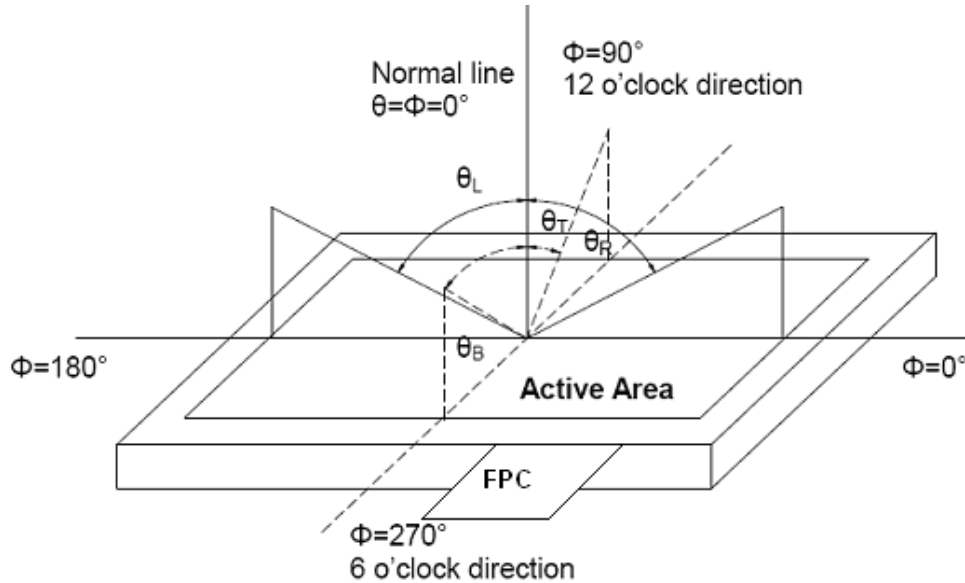

Note 3: Definition of contrast ratio

$$\text{Contrast ratio (CR)} = \frac{\text{Luminance measured when LCD is on the "White" state}}{\text{Luminance measured when LCD is on the "Black" state}}$$

“White state “: The state is that the LCD should drive by V_{white}.

“Black state”: The state is that the LCD should drive by V_{black}.

V_{white}: To be determined V_{black}: To be determined.

Note 4: Definition of Response time

The response time is defined as the LCD optical switching time interval between “White” state and “Black” state. Rise time (T_{ON}) is the time between photo detector output intensity changed from 90% to 10%. And fall time (T_{OFF}) is the time between photo detector output intensity changed from 10% to 90%.

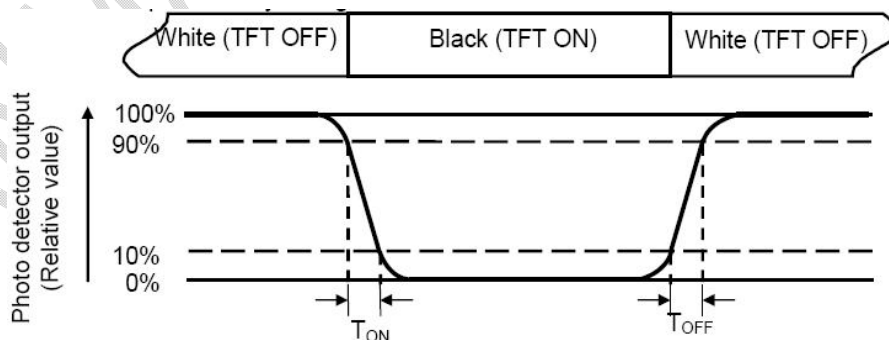

Note 5: Definition of color chromaticity (CIE1931)

- (1) Color coordinates measured at center point of LCD.
- (2) For reflective mode color chromaticity we need to test at least 3 different batches to make sure the stability of panel and it accepts reasonable change after we get the stability data.

The information contained herein is the exclusive property of TIANMA MICRO-ELECTRONICS Corporation and shall not be distributed, reproduced, or disclosed in whole or in part without prior written permission of TIANMA MICRO-ELECTRONICS Corporation.

7 Environmental / Reliability Test

| No | Test Item | Condition | Remarks |
|----|--|--|---|
| 1 | High Temperature Operation | Ta=+70°C, 240hrs | IEC60068-2-1:2007 GB2423.2-2008 |
| 2 | Low Temperature Operation | Ta=-20°C, 240hrs | IEC60068-2-1:2007 GB2423.1-2008 |
| 3 | High Temperature Storage | Ta=+85°C, 240hrs | IEC60068-2-1:2007 GB2423.2-2008 |
| 4 | Low Temperature Storage | Ta=-30°C, 240hrs | IEC60068-2-1:2007 GB2423.1-2008 |
| 5 | Storage at High Temperature and Humidity | Ta=+60°C, 90% RH 240 hours | IEC60068-2-78 :2001 GB/T2423.3—2006 |
| 6 | Thermal Shock (non-operation) | -40°C 60 min~+85°C 60 min, Change time:5min, 50 Cycles | Start with cold temperature, End with high temperature, IEC60068-2-14:1984,GB2423.22-2002 |
| 7 | ESD | C=150pF, R=330Ω · 5points/panel Air:±6KV, 5times; Contact:±4KV, 5 times; (Environment: 15°C~35°C, 30%~60%, 86Kpa~106Kpa) | IEC61000-4-2:2001 GB/T17626.2-2006 |
| 8 | Vibration Test | Frequency range:10~55Hz, Stroke:1.5mm Sweep:10Hz~55Hz~10Hz 2 hours for each direction of X.Y.Z. (for total)(Package condition) | IEC60068-2-6:1982 GB/T2423.10—1995 |
| 9 | Mechanical Shock (Non OP) | 60G 6ms, ±X,±Y,±Z 3times, for each direction | IEC60068-2-27:1987 GB/T2423.5—1995 |
| 10 | Package Drop Test | Drop onto the field floor from 76 cm heights, 6 faces, 3 edges and one of 8 corners. Total is 10 times | IEC60068-2-32:1990 GB/T2423.8—1995 |
| 11 | Image sticking test | 40° 6 hours, release 40min | No Image sticking |

Note1: Ta is the ambient temperature of sample.

Note2: Before cosmetic and function test, the product must have enough recovery time, at least 2 hours at room temperature.

Note 3: In the standard condition, there shall be no practical problem that may affect the display function. After the reliability test, the product only guarantees operation, but don't guarantee all of the cosmetic specification.

Note 4: Image sticking test is as below.

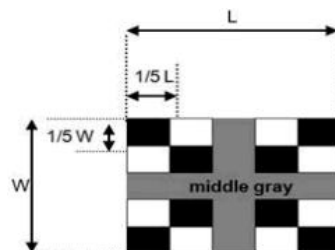

The information contained herein is the exclusive property of TIANMA MICRO-ELECTRONICS Corporation and shall not be distributed, reproduced, or disclosed in whole or in part without prior written permission of TIANMA MICRO-ELECTRONICS Corporation.

8 Mechanical Drawing

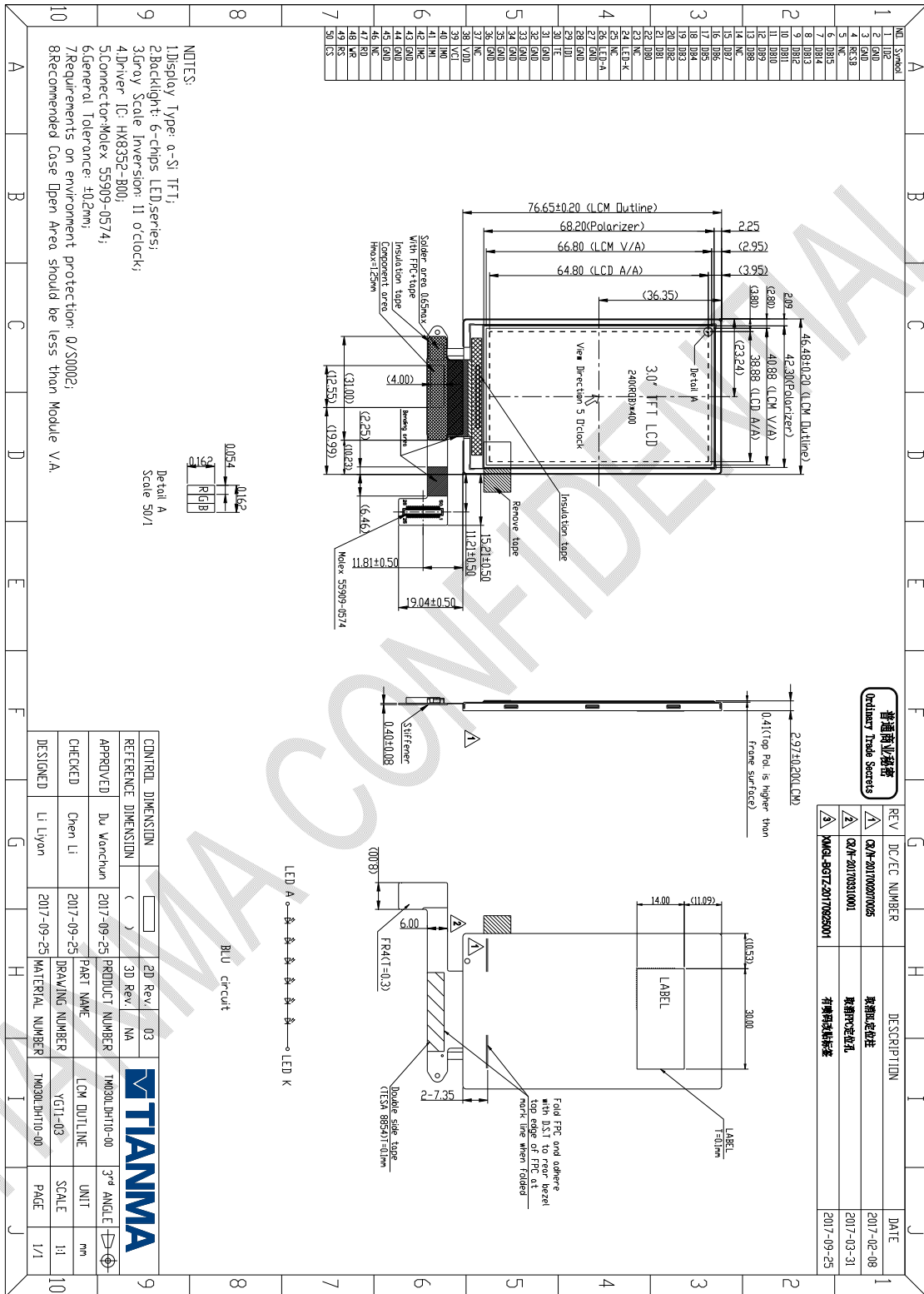

9 Packing Drawing

9.1 Packaging flow

| No | Item | Model (Material) | Dimensions(m m) | Unit Weight(Kg) | Quantity | Remark | |
|----|----------------|------------------|------------------|-----------------|----------|--------|--|
| 1 | LCM module | TM030LDHT13-00 | 76.65*46.48*2.97 | 0.0212 | 336 | | |
| 2 | Carton | Corrugated paper | 544*365*250 | 1.01 | 1 | | |
| 3 | Dust-Proof Bag | PE | 700*545*0.05 | 0.046 | 1 | | |
| 4 | EPE | EPE | 485*330*5 | 0.08 | 3 | | |
| 5 | Tray | PET(Transmit) | 485*330*13.8 | 0.156 | 24 | | |
| 6 | BOX | Corrugated paper | 520*345*74 | 0.44 | 3 | | |
| 7 | Total weight | $13.48 \pm 10\%$ | | | | | |

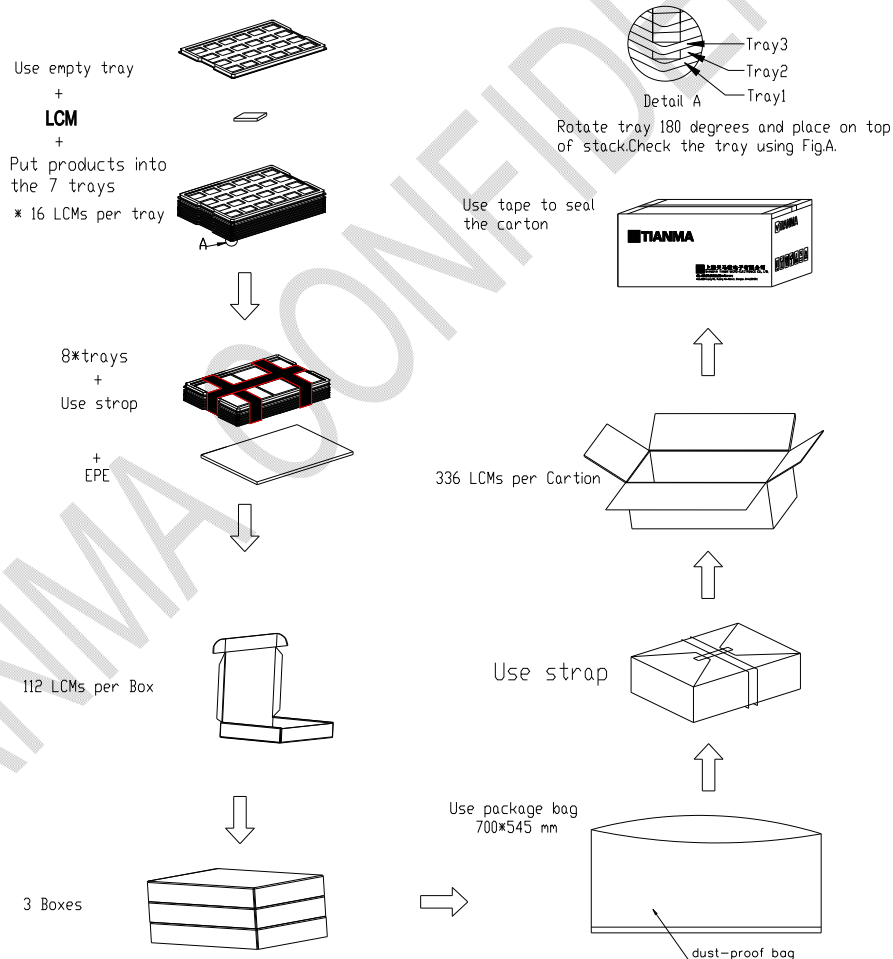

10 Precautions for Use of LCD Modules

10.1 Handling Precautions

10.1.1 The display panel is made of glass. Do not subject it to a mechanical shock by dropping it from a high place, etc.

10.1.2 If the display panel is damaged and the liquid crystal substance inside it leaks out, be sure not to get any in your mouth, if the substance comes into contact with your skin or clothes, promptly wash it off using soap and water.

10.1.3 Do not apply excessive force to the display surface or the adjoining areas since this may cause the color tone to vary.

10.1.4 The polarizer covering the display surface of the LCD module is soft and easily scratched. Handle this polarizer carefully.

10.1.5 If the display surface is contaminated, breathe on the surface and gently wipe it with a soft dry cloth. If still not completely clear, moisten cloth with one of the following solvents:

- Isopropyl alcohol
- Ethyl alcohol

Solvents other than those mentioned above may damage the polarizer. Especially, do not use the following:

- Water
- Ketone
- Aromatic solvents

10.1.6 Do not attempt to disassemble the LCD Module.

10.1.7 If the logic circuit power is off, do not apply the input signals.

10.1.8 To prevent destruction of the elements by static electricity, be careful to maintain an optimum work environment.

10.1.8.1 Be sure to ground the body when handling the LCD Modules.

10.1.8.2 Tools required for assembly, such as soldering irons, must be properly ground.

10.1.8.3 To reduce the amount of static electricity generated, do not conduct assembly and other work under dry conditions.

10.1.8.4 The LCD Module is coated with a film to protect the display surface. Be care when peeling off this protective film since static electricity may be generated.

10.2 Storage precautions

10.2.1 When storing the LCD modules, avoid exposure to direct sunlight or to the light of fluorescent lamps.

10.2.2 The LCD modules should be stored under the storage temperature range. If the LCD modules will be stored for a long time, the recommend condition is:

Temperature : 0°C ~ 40°C Relatively humidity: ≤80%

10.2.3 The LCD modules should be stored in the room without acid, alkali and harmful gas.

10.3 Transportation Precautions

10.3.1 The LCD modules should be no falling and violent shocking during transportation, and also should avoid excessive press, water, damp and sunshine.

10.4 Bar Code definition on module

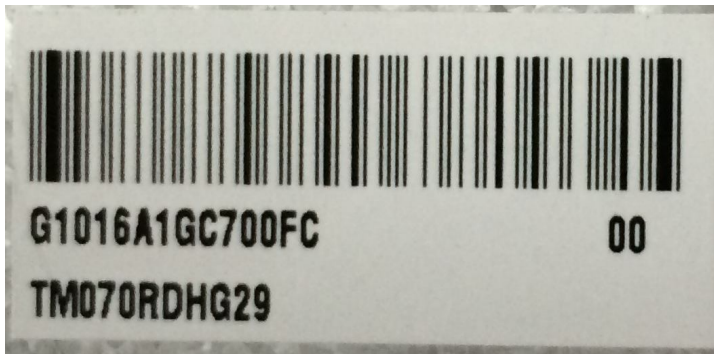

Note: Bar Code definition

Definition label is Panel ID, and it is unique and includes manufacture relevant information, for instance TM070RDHG29. G1016A1GC700FC Label definition as below:

G1016: Produce No.

A1: Produce line

G: 2014 year (A: 2008, B: 2009, C: 2010...);

C: December (1-9:Jan-Sep, A-C: Oct- Dec.)

7: Date 7 (date1-31,from 1-9,A-X,not including I,O)

00FC: Serial No(start from 0001).



上海天馬微電子有限公司
 SHANGHAI TIANMA MICROELECTRONICS CO., LTD.

Shanghai Tianma Micro-Electronics CO.,LTD

TFT-LCD Module Incoming Inspection Standard

| | |
|-------------|------------------|
| Customer | Garmi |
| Description | TFT-LCM |
| Model Name | 3.0 |
| Date | <u>2016.5.31</u> |
| Version | <u>1.1</u> |

| Customer Approval | |
|-------------------|--|
| Title | |
| Name | |
| Date | |

| | Prepared By | Checked by | Approved By |
|--------|-------------|------------|-------------|
| Title: | | | |
| Name: | | | |
| Date: | | | |

HISTORY OF REVISION

| REV NO. | REV DATE | CONTENTS | REMARKS |
|--|-----------|----------|---------|
| 1.0 | 2016-5-27 | | |
| | | | |
| Shanghai Tianma Micro-Electronics CO.,LTD | | | |

1. Scope:

The incoming inspection standards shall be applied to TFT-LCD Modules (hereinafter called "Modules") that supplied by Shanghai Tianma Micro-Electronics Corporation.

2. Incoming Inspection

The customer shall inspect the modules within twenty calendar days of the delivery date (the "inspection period") at its own cost. The result of the inspection (acceptance or rejection) shall be recorded in writing, and a copy of this writing will be promptly sent to the seller, If the results of the inspecting from buyer does not send to the seller within twenty calendar days of the delivery date. The modules shall be regards as acceptance.

Should the customer fail to notify the seller within the inspection period, the buyers right to reject the modules. Shall be lapsed and the modules shall be deemed to have been accepted by the buyer.

3. Inspection Sampling Method

- 3.1. Lot size: Quantity per shipment lot per model
- 3.2. Sampling type: Normal inspection, Single sampling
- 3.3. Inspection level: II
- 3.4. Sampling table: MIL-STD-1916
- 3.5. Acceptable quality level (AQL)
Major defect: accept:0, reject:1
Minor defect: AQL=1.00

4. Inspection Conditions

4.1 Ambient conditions:

- a. Temperature: Room temperature $25\pm 5^{\circ}\text{C}$
- b. Humidity: $(60\pm 10)\% \text{RH}$
- c. Illumination: Appearance 700 ± 100 Lux, Display 100 ± 50 Lux (The luminance at an inspection desk surface with single non-directive fluorescent lamp)

4.2 Viewing distance

The distance between the LCD and the inspector's eyes shall be at least 30 ± 5 cm.

4.3 Viewing Angle

I / D: $45^{\circ}/45^{\circ}$ I / R: $45^{\circ}/45^{\circ}$

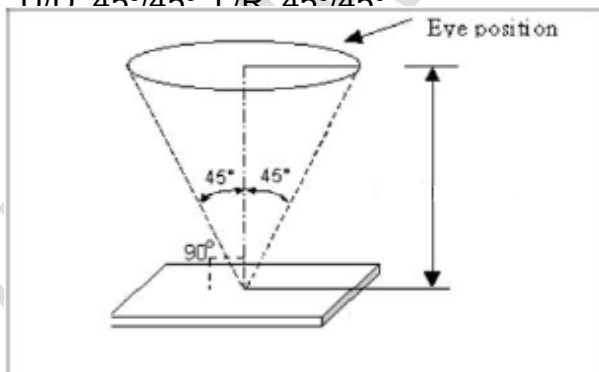

5. Inspection Criteria

The information contained herein is the exclusive property of TIANMA MICRO-ELECTRONICS Corporation and shall not be distributed, reproduced, or disclosed in whole or in part without prior written permission of TIANMA MICRO-ELECTRONICS Corporation.

Defects are classified as major defects and minor defects according to the degree of defectiveness defined herein.

5.1 Major defect

| Item No | Items to be inspected | Inspection Standard |
|---------|------------------------|--|
| 5.1.1 | All functional defects | 1) No display 2) Display abnormally 3) Short circuit 4) line defect |
| 5.1.2 | missing | Missing function component |
| 5.1.3 | Crack | Glass Crack |

5.2 Minor defect

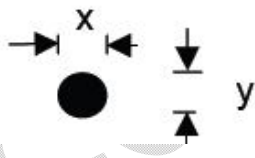
| Item No | Items to be inspected | Inspection standard | |
|---------|---|---|--|
| 5.2.1 | Spot Defect Including Black spot White spot Pinhole Foreign particle Polarizer dirt | For dark/white spot is defined $\varphi = (x+y) / 2$ | |
| | |  | |
| | | Size φ (mm) | Acceptable Quantity |
| | | $\varphi \leq 0.1$ | Ignore |
| | | $0.1 < \varphi \leq 0.2$ | 2 two defects distance must over 3mm |
| | | $0.2 < \varphi$ | Not allowed |
| 5.2.2 | Line Defect | Define: | |

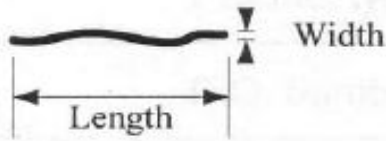
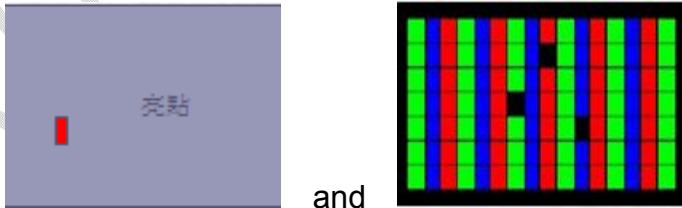
| | | | |
|-----------|--|--|--|
| | Including Black line White line Scratch |  | |
| | | Width(mm) Length(mm) | Acceptable Quantity |
| | | $W \leq 0.02$ | Ignore |
| | | $0.02 < W \leq 0.05$ $L \leq 2.0$ | 1 Two defects distance must over 3mm |
| | | $0.05 < W$ | Follow 5.2.1 |
| 5.2.3 | Polarizer Dent/Bubble | Size ϕ (mm) | Acceptable Quantity |
| | | $\phi \leq 0.1$ | Ignore |
| | | $0.1 < \phi \leq 0.2$ | 2 two defects distance must over 3mm |
| | | $0.2 < \phi$ | Not allowed |
| 5.2.4 | Electrical Dot Defect | Bright and Black dot define: | |
| | |  | |
| | | Item | Acceptable Quantity |
| | | Dark dot defect | 2 |
| | | Bright dot defect | 0 |
| Total Dot | 2 | | |
| 5.2.5 | Pol 异物 Cell 异物 (发亮) | Size ϕ (mm) | Acceptable Quantity |
| | | $\phi \leq 0.1$ | Ignore |
| | | $0.1 < \phi \leq 0.2$ | 2 |

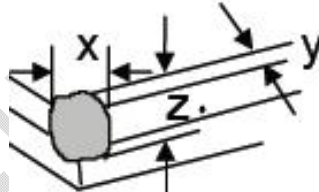
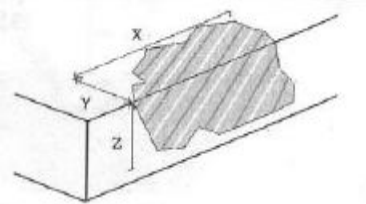
| | | | |
|-------|-----------------------------------|---|--|
| | | | two defects distance must over 3mm |
| | | $0.2 < \phi$ | Not allowed |
| 5.2.6 | 密集微小亮点 | 微小亮点判定方法: $\Phi < 0.1\text{mm}$ | |
| | | Not accepted under 2% ND filter | |
| 5.2.7 | Mura | Not accepted under 6% ND filter, but a limits sample will be allowed | |
| 5.2.8 | FPC | Broken | Not allowed |
| | | FPC 折痕、压痕、顶伤 | 不可裸线、漏洞 弯曲不可形成锐角 |
| 5.2.9 | Glass defect & Touch panel defect | 1. Corner Fragment:  | |
| | | Size(mm) | Acceptable Quantity |
| | | X ≤ 3mm Y ≤ 3mm Z ≤ T | Ignore T : Glass thickness X: Length Y: Width Z: thickness |
| | | 2. Side Fragment:  | |
| | | Size(mm) | Acceptable Quantity |

| | | | |
|--------|-------------------------|--|--|
| | | $X \leq 5.0\text{mm}$ $Y \leq 1.0\text{mm}$ $Z \leq T$ | Ignore T : Glass thickness X: Length Y: Width Z: thickness |
| 5.2.10 | Touch panel spot | Size ϕ (mm) | Acceptable Quantity |
| | | $\phi \leq 0.20$ | Ignore |
| | | $0.20 < \phi \leq 0.30$ | 3 |
| | | $0.30 < \phi$ | Not allowed |
| 5.2.11 | Touch panel newton ring | Compare with limit sample | |
| 5.2.12 | Bezel | Dirt | No harm |
| | | Wrap | |
| | | Broken | |
| | | 凹陷 | No dangerous |
| 5.2.13 | 检验画面 | red · green · blue · black · white · color scale · PIC · Image sticking · Cross-talk · flicker | |

- Note:
1. Dot defect is defined as the defective area of the dot area is larger than 50% of the dot area.
 2. Polarizer bubble is defined as the bubble appears on active display area. The defect of polarizer bubble shall be ignored if the polarizer bubble appears on the outside of active display area.
 3. ND 使用方法：ND 与 panel 平行垂直距离 3~5cm，肉眼与 panel 正视距离 $30 \pm 5\text{cm}$
 4. Foreign particle on the surface of the LCM should be ignored.

6. Mechanics specification

As for the outside dimension, weight of the modules, please refer to product specification for more details

7. Precaution

Please pay attention to the following items when you use the LCD Modules:

- 7-1 Do not twist or bend the module and prevent the unsuitable external force for

The information contained herein is the exclusive property of TIANMA MICRO-ELECTRONICS Corporation and shall not be distributed, reproduced, or disclosed in whole or in part without prior written permission of TIANMA MICRO-ELECTRONICS Corporation.

- display module during assembly.
- 7-2 Adopt measures for good heat radiation. Be sure to use the module with in the specified temperature.
 - 7-3 Avoid dust or oil mist during assembly.
 - 7-4 Following the correct power sequence while operating. Do not apply the invalid signal, otherwise, it will cause improper shut down and damage the module.
 - 7-5 Less EMI: it will be more safety and less noise.
 - 7-6 Please operate module in suitable temperature. The response time & brightness will drift by different temperature.
 - 7-7 Avoid to display the fixed pattern (exclude the white pattern) in a long period, otherwise, it will cause image stains.
 - 7-8 Be sure to turn off the power when connection of disconnecting the circuit.
 - 7-9 Polarizer scratches easily, please handle it carefully.
 - 7-10 Display surface never likes dirt of stains.
 - 7-11 A dew drop may lead to destruction. Please wipe off and moisture before using module.
 - 7-12 Sudden temperature changes cause condensation, and it will cause polarizer damaged.
 - 7-13 High temperature and humidity may degrade performance. Please do not expose the module to the direct sunlight and so on.
 - 7-14 Acetic acid or chlorine compounds are not friends with TFT display module.
 - 7-15 Static electricity will damage the module, please do not touch the module without any grounded device.
 - 7-16 Do not disassemble and reassemble the module by self.
 - 7-17 Be careful do not touch the rear side directly.
 - 7-18 Not strong vibration or shock. It will cause module broken.
 - 7-19 Storage the modules in suitable environment with regular packing.
 - 7-20 Be careful or injury from a broken display module.
 - 7-21 Please avoid the pressure adding to the surface (front or rear side) of modules, because it will cause the display non-uniformity of other function issue.
 - 7-22 Please follow the storage environment conditions:
 - a. Temperature: Room temperature $23\pm 4^{\circ}\text{C}$
 - b. Humidity: $(50\pm 30)\% \text{RH}$.
 - 7-23 Display warranty period is one year.

Our company network supports you worldwide with offices in Germany, Austria, Switzerland, the UK and the USA. For more information please contact:

Headquarters

Germany



FORTEC Elektronik AG

Augsburger Str. 2b
82110 Germering

Phone: +49 89 894363-0
E-Mail: sales@fortecag.de
Internet: www.fortecag.de

Fortec Group Members

Austria



FORTEC Elektronik AG

Office Vienna

Nuschinggasse 12
1230 Wien

Phone: +43 1 8673492-0
E-Mail: office@fortec.at
Internet: www.fortec.at

Germany



Distec GmbH

Augsburger Str. 2b
82110 Germering

Phone: +49 89 894363-0
E-Mail: info@distec.de
Internet: www.distec.de



FORTEC Elektronik AG

Lechwiesenstraße 9
86899 Landsberg am Lech

Phone: +49 8191 91172-0
E-Mail: sales@fortecag.de
Internet: www.fortecag.de

Switzerland



ALTRAC AG

Bahnhofstraße 3
5436 Würenlos

Phone: +41 44 7446111
E-Mail: info@altrac.ch
Internet: www.altrac.ch

United Kingdom



Display Technology Ltd.

Osprey House, 1 Osprey Court
Hichingbrooke Business Park
Huntingdon, Cambridgeshire, PE29 6FN

Phone: +44 1480 411600
E-Mail: info@displaytechnology.co.uk
Internet: www.displaytechnology.co.uk

USA



Apollo Display Technologies, Corp.

87 Raynor Avenue,
Unit 1 Ronkonkoma,
NY 11779

Phone: +1 631 5804360
E-Mail: info@apolloDisplays.com
Internet: www.apolloDisplays.com