



OUR GLOBAL  
COMPETENCE  
CENTRES

 APOLLO DISPLAY  
TECHNOLOGIES



 DISTEC



 DISPLAY  
TECHNOLOGY



# Datasheet

## AUO

D\* ) \$ < J B \$ ) ' %

WÜEGEJ€

# Model Name: P650HVN05.1

Issue Date : 2018/10/30

( ) Preliminary Specifications

(\* ) Final Specifications

Customer Signature	Date	AUO	Date
Approved By		Approval By PM Director CT Wu <i>CTWu</i>	
Note		Reviewed By RD Director Eugene CC Chen <i>陳品川</i>	
		Reviewed By Project Leader Jerry Lin <i>Jerry Lin</i>	
		Prepared By PM FC Tsao <i>FC Tsao</i>	

## Contents

<b>1. General Description</b> .....	4
1.1. Display Characteristics.....	4
1.2. Optical Characteristics.....	5
1.3. Mechanical Characteristics.....	8
1.3.1. Placement Suggestions.....	8
2. Absolute Maximum Ratings.....	12
3. Electrical Specification.....	13
3.1. Electrical Characteristics.....	13
3.1.1 Input Power.....	13
3.3 Input Data Format.....	17
3.3.2 Color Input Data Reference.....	18
3.4 Signal Timing Specification.....	19
3.4.1.2 Signal Timing Waveforms.....	20
3.4.2.1 LVDS.....	21
3.4.3 Power Sequence for LCD.....	24
3.5 Backlight Specification.....	25
3.5.1 Electrical specification.....	25
3.5.2 Input Pin Assignment.....	26
3.5.3 Power Sequence for Backlight.....	30
3.5.4 LED Operating Life Time.....	31
4. Reliability Test Items.....	32
5. International Standard.....	33
5.1. Safety.....	33
5.2. EMC.....	33
6. Packing.....	34
6.1. Definition of Label.....	34
6.2. Packing Methods.....	35
6.3. Pallet and Shipment Information.....	36
7. Precautions.....	37
7.1. Mounting Precautions.....	37
7.2. Operating Precautions.....	37
7.3. Operating Condition for Public Information Display.....	38
7.4. Electrostatic Discharge Control.....	38
7.5. Precautions for Strong Light Exposure.....	38
7.6. Storage.....	39
7.7. Handling Precautions for Protection Film.....	39



# 1. General Description

This specification applies to the 65 inch Color TFT-LCD Module P650HVN05.1. This LCD module has a TFT active matrix type liquid crystal panel 1920x1080 pixels, and diagonal size of 64.5 inch. This module supports 1920x1080 mode. Each pixel is divided into Red, Green and Blue sub-pixels or dots which are arranged in vertical stripes. Gray scale or the brightness of the sub-pixel color is determined with a 10-bit gray scale signal for each dot.

The P650HVN05.1 has been designed to apply the 10-bit 2 channels LVDS (Jeida mode) interface method. It is intended to support displays where high brightness, wide viewing angle, high color saturation, and high color depth are very important. High Tni (110°C) liquid crystal and QWP (quarter wave plate) polarizer are also applied on this model to enhance the sunlight readability.

## \* General Information

### 1.1. Display Characteristics

Items	Specification	Unit	Note
Active Screen Size	64.53	inch	
Display Area	1428.48 (H) x 803.52 (V)	mm	
Outline Dimension	1450.38 (H) x 825.42 (V) x 50(D)	mm	D: front bezel to back bezel
Driver Element	a-Si TFT active matrix		
Bezel Opening	1430.78x805.82	mm	
Display Colors	10 bit	Colors	Only for Jeida mode
Number of Pixels	1920x1080	Pixel	
Pixel Pitch	0.744 (H) x 0.744(W)	mm	
Pixel Arrangement	RGB vertical stripe		
Display Operation Mode	Normally Black		
Surface Treatment	2H, Low Reflection, QWP		Reflectance $\leq$ 2%
Rotate Function	Unachievable		Note 1
Display Orientation	Portrait/Landscape Enabled		Note 2

Note 1: Rotate Function refers to LCD display could be able to rotate. This function does not work in this model.

Note 2: Please refer to 1.3.1 Placement Suggestions.

**1.2. Optical Characteristics**

Optical characteristics are determined on the back-light of measured unit is 'ON' and stabilized after 45-60 minutes in a dark environment at 25°C. The values are specified at 50cm distance from the LCD surface at a viewing angle of  $\phi$  and  $\theta$  equal to 0°.

Fig.1 presents additional information concerning the measurement equipment and method.

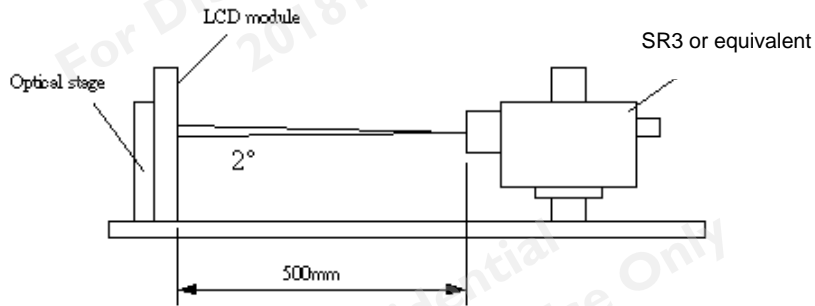

Parameter	Symbol	Values			Unit	Notes
		Min.	Typ.	Max		
Contrast Ratio	CR	3200	4000	--		1
Surface Luminance (White)	$L_{WH}(2D)$	2000	2500	--	cd/m <sup>2</sup>	2
Luminance Variation	$\delta_{WHITE(9P)}$	--	--	1.3		3
Response Time (G to G)	T <sub>Y</sub>	--	8	--	ms	4
Color Gamut	NTSC		72		%	
Color Coordinates						
	Red	R <sub>X</sub>	Typ.-0.03	0.652	Typ.+0.03	
		R <sub>Y</sub>		0.332		
	Green	G <sub>X</sub>		0.300		
		G <sub>Y</sub>		0.623		
	Blue	B <sub>X</sub>		0.150		
		B <sub>Y</sub>		0.050		
	White	W <sub>X</sub>		0.280		
		W <sub>Y</sub>		0.290		
Viewing Angle						
	x axis, right( $\phi=0^\circ$ )	$\theta_r$	--	89	--	degree
	x axis, left( $\phi=180^\circ$ )	$\theta_l$	--	89	--	degree
	y axis, up( $\phi=90^\circ$ )	$\theta_u$	--	89	--	degree
	y axis, down ( $\phi=270^\circ$ )	$\theta_d$	--	89	--	degree

Note:

1. Contrast Ratio (CR) is defined mathematically as:

$$\text{Contrast Ratio} = \frac{\text{Surface Luminance of } L_{on5}}{\text{Surface Luminance of } L_{off5}}$$

2. Surface luminance is luminance value at point 5 across the LCD surface 50cm from the surface with all pixels displaying white. From more information see FIG 2. LED current  $I_F$  = typical value (without driver board), LED input  $V_{DDB} = 24V$ ,  $I_{DDB}$  = Typical value (with driver board),  $L_{WH} = L_{on5}$  where  $L_{on5}$  is the luminance with all pixels displaying white at center 5 location.

3. The variation in surface luminance,  $\delta_{WHITE}$  is defined (center of Screen) as:

$$\delta_{WHITE(9P)} = \frac{\text{Maximum}(L_{on1}, L_{on2}, \dots, L_{on9})}{\text{Minimum}(L_{on1}, L_{on2}, \dots, L_{on9})}$$

4. Response time  $T_\gamma$  is the average time required for display transition by switching the input signal for five luminance ratio (0%, 25%, 50%, 75%, 100% brightness matrix) and is based on  $F_v = 60\text{Hz}$  to optimize.

Measured Response Time		Target				
		0%	25%	50%	75%	100%
Start	0%		0% to 25%	0% to 50%	0% to 75%	0% to 100%
	25%	25% to 0%		25% to 50%	25% to 75%	25% to 100%
	50%	50% to 0%	50% to 25%		50% to 75%	50% to 100%
	75%	75% to 0%	75% to 25%	75% to 50%		75% to 100%
	100%	100% to 0%	100% to 25%	100% to 50%	100% to 75%	

$T_\gamma$  is determined by 10% to 90% brightness difference of rising or falling period. (As illustrated)  
The response time is defined as the following figure and shall be measured by switching the input signal for “any level of gray(bright)” and “any level of gray(dark)”.

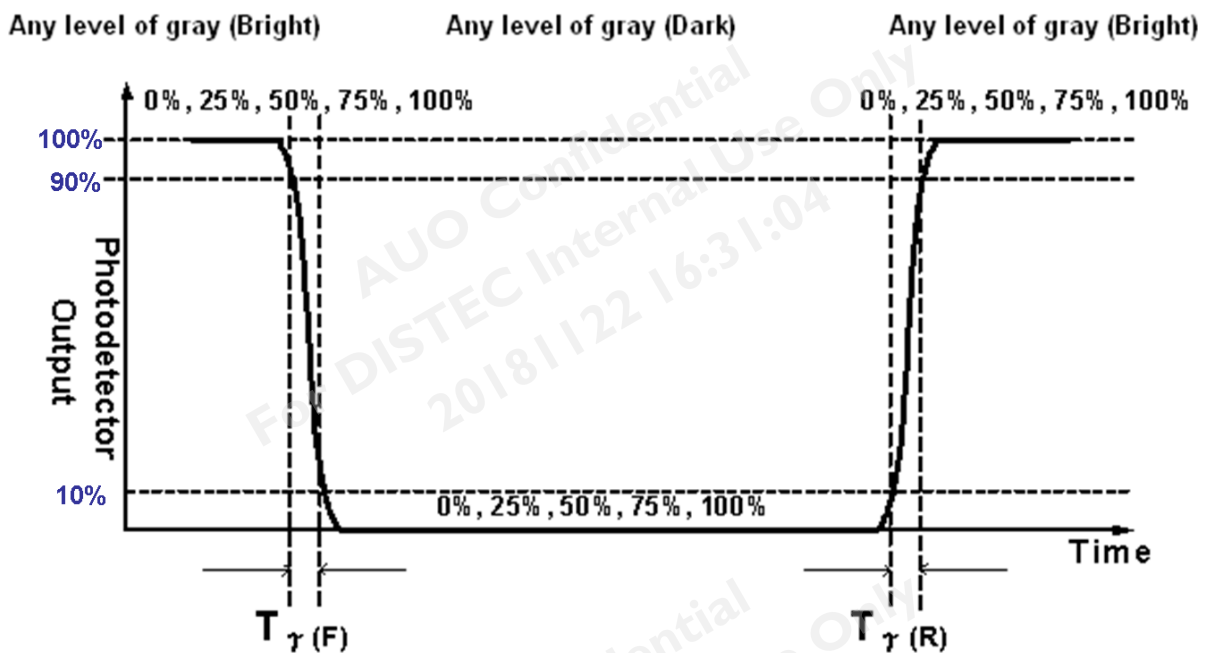
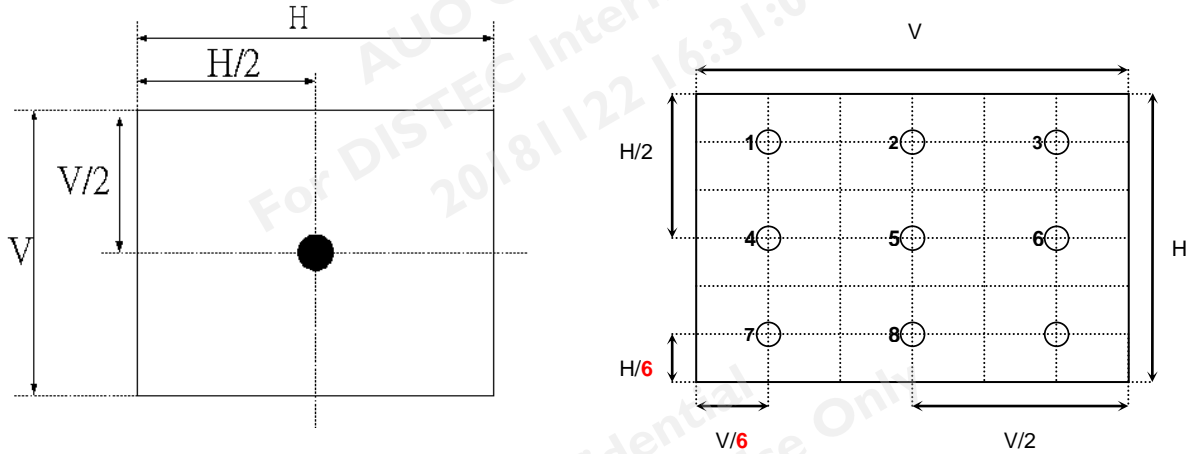

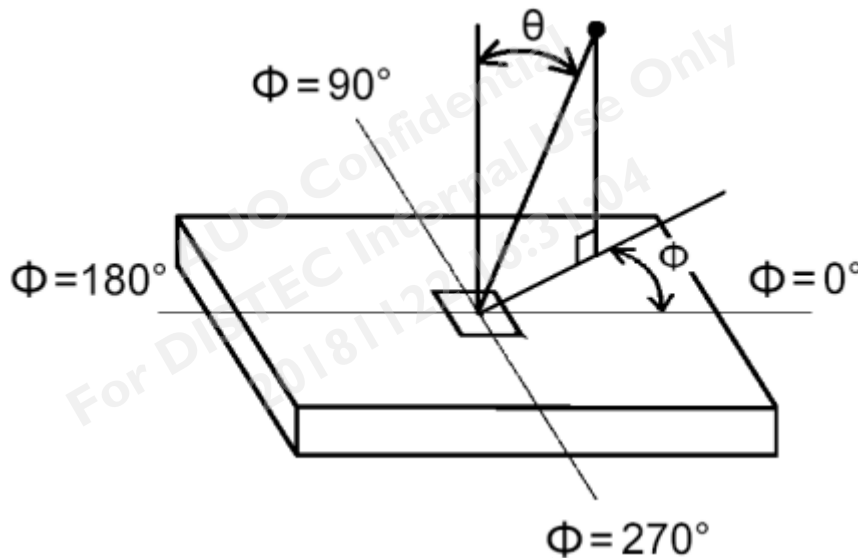

FIG. 2 Luminance



- Viewing angle is the angle at which the contrast ratio is greater than 10. The angles are determined for the horizontal or x axis and the vertical or y axis with respect to the z axis which is normal to the LCD surface. For more information see FIG3.

FIG.3 Viewing Angle



**1.3. Mechanical Characteristics**

The contents provide general mechanical characteristics for the model P650HVN05.1. In addition, the figures in the next page are detailed mechanical drawing of the LCD.

Item	Dimension	Unit	Note	
Outline Dimension	Horizontal	1450.38	mm	
	Vertical	825.42	mm	
	Depth (Dmin)	50	mm	front bezel to back bezel
	Depth (Dmax)	80	mm	to wall mount
Weight	20000	G	w/ DB	

**1.3.1. Placement Suggestions**

1. Landscape Mode: The default placement is T-Con Side on the lower side and the image is shown upright via viewing from the front.
2. Portrait Mode: The default placement is that T-Con side has to be placed on the left side via viewing from the front.

**Landscape (Front view)**

**Portrait (Front view)**

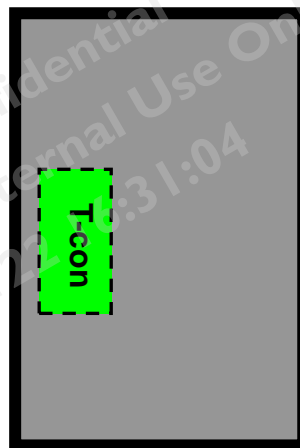
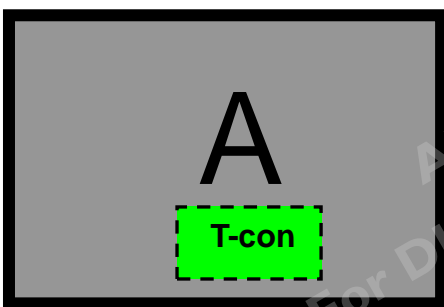

## Front View

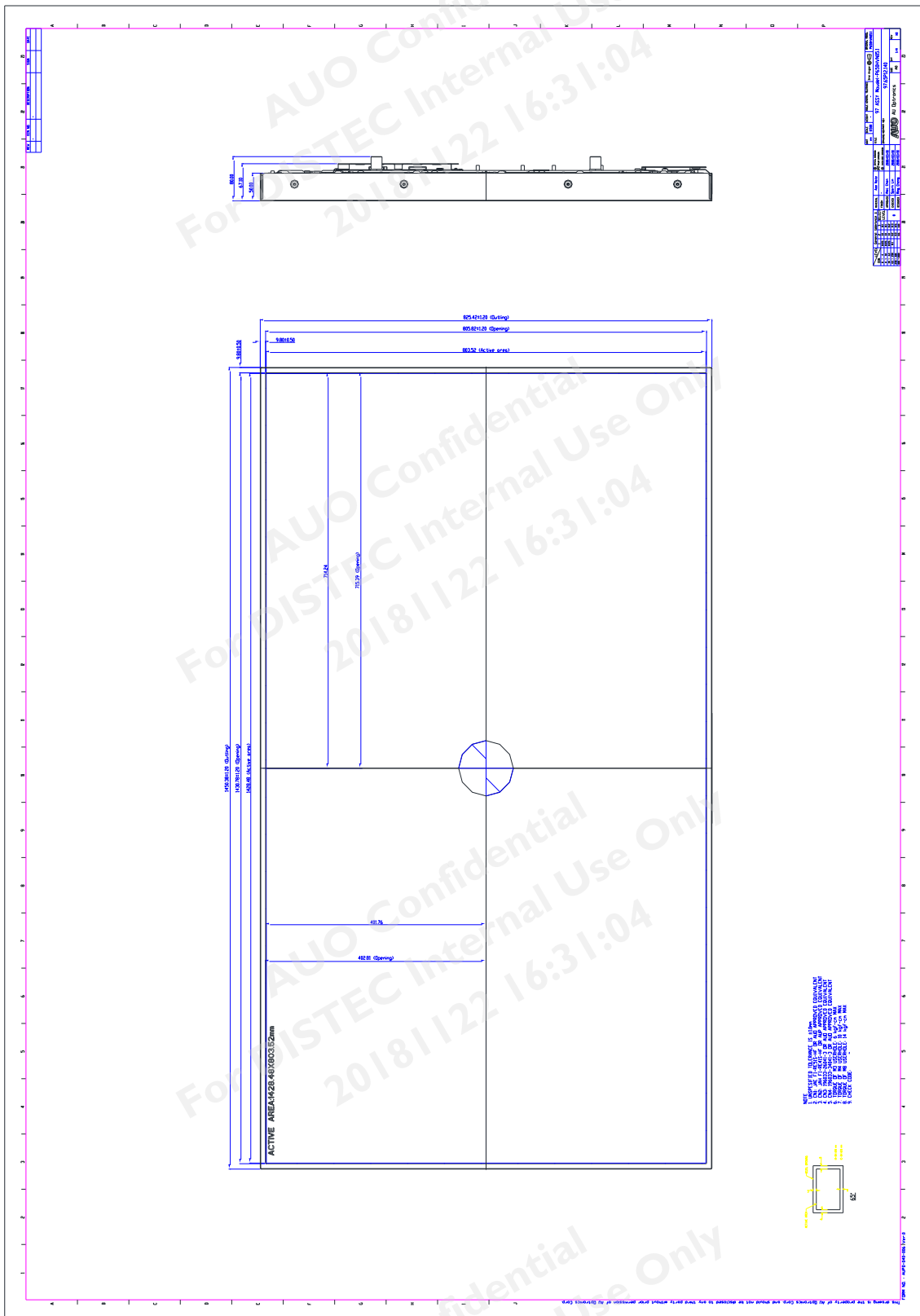



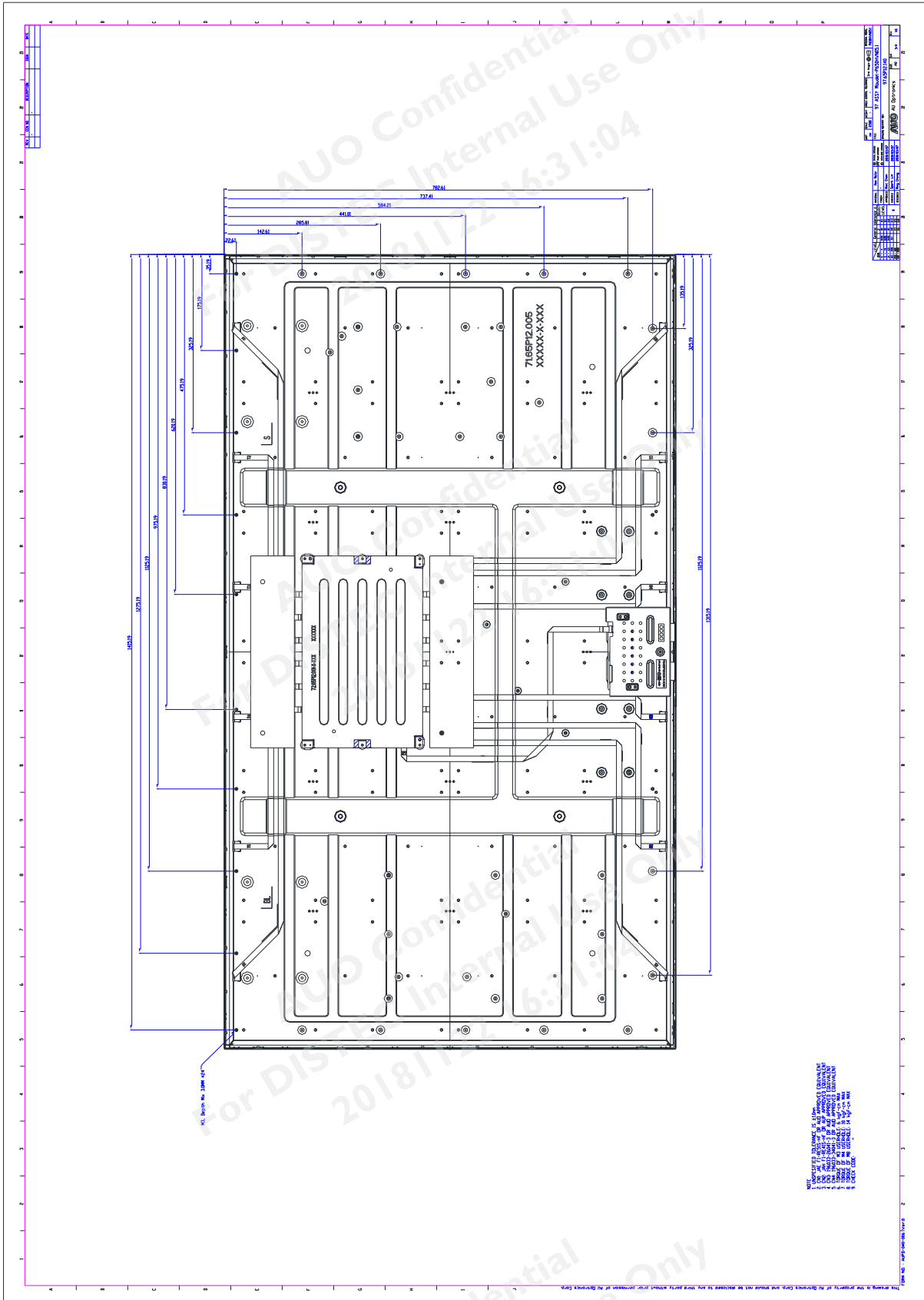

## 2. Absolute Maximum Ratings

The followings are maximum values which, if exceeded, may cause faulty operation or damage to the unit

Item	Symbol	Min	Max	Unit	Conditions
Logic/LCD Drive Voltage	Vcc	-0.3	14	[Volt]	Note 1
Input Voltage of Signal	Vin	-0.3	4	[Volt]	Note 1
Operating Temperature	TOP	0	+50	[°C]	Note 2
Operating Humidity	HOP	10	90	[%RH]	Note 2
Storage Temperature	TST	-20	+60	[°C]	Note 2
Storage Humidity	HST	10	90	[%RH]	Note 2
Panel Surface Temperature	PST	---	65	[°C]	Note 3

Note 1: Duration:50 msec.

Note 2 : Maximum Wet-Bulb should be 39°C and No condensation.

The relative humidity must not exceed 90% non-condensing at temperatures of 40°C or less. At temperatures greater than 40°C, the wet bulb temperature must not exceed 39°C

Note 3: Surface temperature is measured at 50°C Dry condition

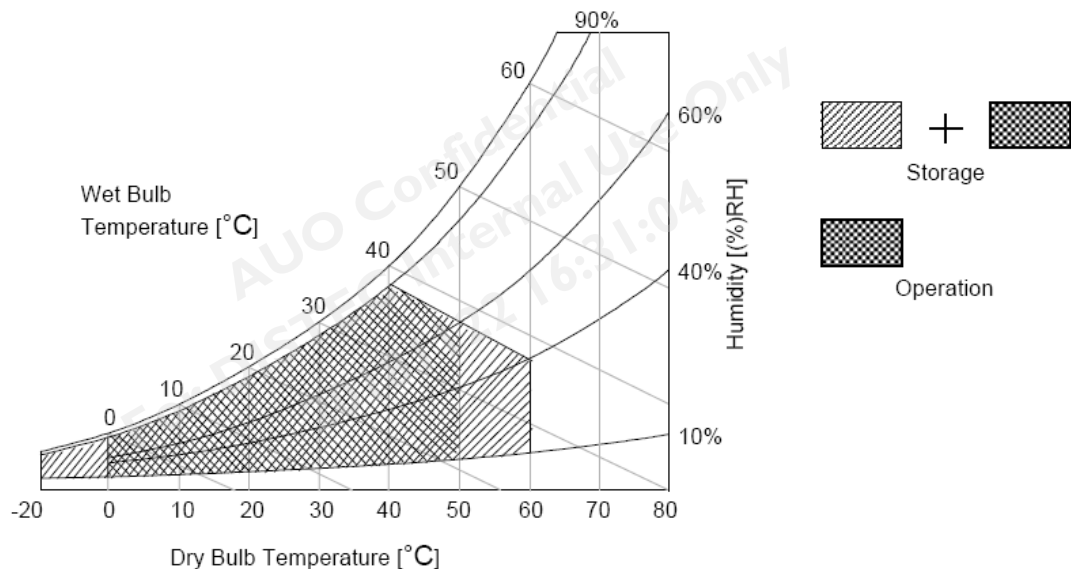

### 3. Electrical Specification

The P650HVN05.1 requires two power inputs. One is employed to power the LCD electronics and to drive the TFT array and liquid crystal. The other is to power Back Light Unit.

#### 3.1. Electrical Characteristics

##### 3.1.1 Input Power

Item	Symbol	Min.	Typ.	Max	Unit	Note
Power Supply Input Voltage	V <sub>DD</sub>	10.8	12	13.2	V	1
Power Supply Input Current	Black pattern	-	0.7	0.8	A	2
	White pattern	-	0.75	0.85	A	
	H-strip pattern	-	1.45	1.65	A	
Power Consumption	Black pattern	-	8.4	9.6	Watt	2
	White pattern	-	9.0	10.2	Watt	
	H-strip pattern	-	17.4	19.8	Watt	
Inrush Current	I <sub>RUSH</sub>	--	--	7.5	A	3

**Note1.** The ripple voltage should be fewer than 5% of VDD.

**Note2.** Test Condition:

- (1) V<sub>DD</sub> = 12.0V, (2) F<sub>v</sub> = 60Hz, (3) F<sub>clk</sub> = 74.25MHz, (4) Temperature = 25 °C
- (5) Power dissipation check pattern. (Only for power design)

a. Black pattern

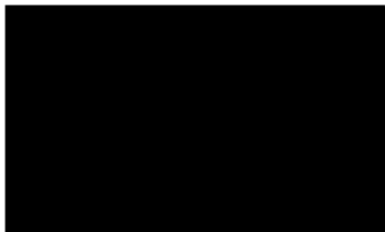

b. White pattern

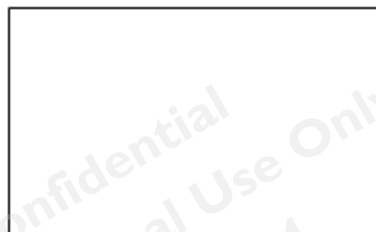

c. H-Strip pattern

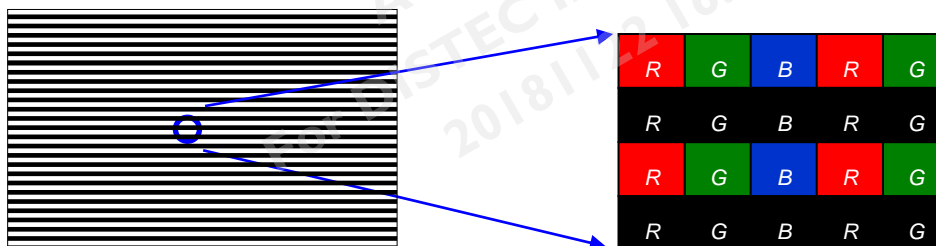

Note3. Measurement condition : Rising time = 400us

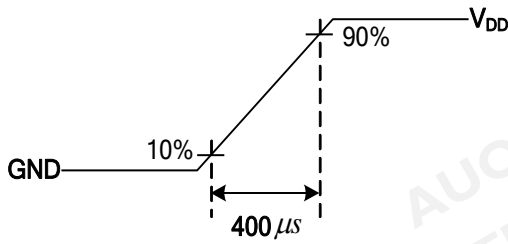

### 3.2 input Connections

- LCD connector: JAE FI-RTE51SZ-HF or equivalent

PIN	Symbol	Description	Note
1	N.C.	No connection (for AUO test only. Do not connect)	2
2	N.C.	No connection (for AUO test only. Do not connect)	2
3	N.C.	No connection (for AUO test only. Do not connect)	2
4	N.C.	No connection (for AUO test only. Do not connect)	2
5	N.C.	No connection (for AUO test only. Do not connect)	2
6	N.C.	No connection (for AUO test only. Do not connect)	2
7	N.C.	No connection (for AUO test only. Do not connect)	2
8	N.C.	No connection (for AUO test only. Do not connect)	2
9	LD_EN	Local Dimming Enable Pin (High for Enable, Default/Low for Disable)	3,4
10	N.C.	No connection (for AUO test only. Do not connect)	2
11	GND	Ground	
12	CH1_0-	LVDS Channel 1, Signal 0-	
13	CH1_0+	LVDS Channel 1, Signal 0+	
14	CH1_1-	LVDS Channel 1, Signal 1-	
15	CH1_1+	LVDS Channel 1, Signal 1+	
16	CH1_2-	LVDS Channel 1, Signal 2-	
17	CH1_2+	LVDS Channel 1, Signal 2+	
18	GND	Ground	
19	CH1_CLK-	LVDS Channel 1, Clock -	
20	CH1_CLK+	LVDS Channel 1, Clock +	
21	GND	Ground	
22	CH1_3-	LVDS Channel 1, Signal 3-	
23	CH1_3+	LVDS Channel 1, Signal 3+	
24	CH1_4-	LVDS Channel 1, Signal 4-	
25	CH1_4+	LVDS Channel 1, Signal 4+	
26	GND	Ground	



27	GND	Ground	
28	CH2_0-	LVDS Channel 2, Signal 0-	
29	CH2_0+	LVDS Channel 2, Signal 0+	
30	CH2_1-	LVDS Channel 2, Signal 1-	
31	CH2_1+	LVDS Channel 2, Signal 1+	
32	CH2_2-	LVDS Channel 2, Signal 2-	
33	CH2_2+	LVDS Channel 2, Signal 2+	
34	GND	Ground	
35	CH2_CLK-	LVDS Channel 2, Clock -	
36	CH2_CLK+	LVDS Channel 2, Clock +	
37	GND	Ground	
38	CH2_3-	LVDS Channel 2, Signal 3-	
39	CH2_3+	LVDS Channel 2, Signal 3+	
40	CH2_4-	LVDS Channel 2, Signal 4-	
41	CH2_4+	LVDS Channel 2, Signal 4+	
42	GND	Ground	
43	N.C.	No connection (for AUO test only. Do not connect)	2
44	GND	Ground	
45	GND	Ground	
46	GND	Ground	
47	N.C.	No connection (for AUO test only. Do not connect)	2
48	VDD	Power Supply, +12V DC Regulated	
49	VDD	Power Supply, +12V DC Regulated	
50	VDD	Power Supply, +12V DC Regulated	
51	VDD	Power Supply, +12V DC Regulated	

Note1. Pin number start from the left side as the following figure.

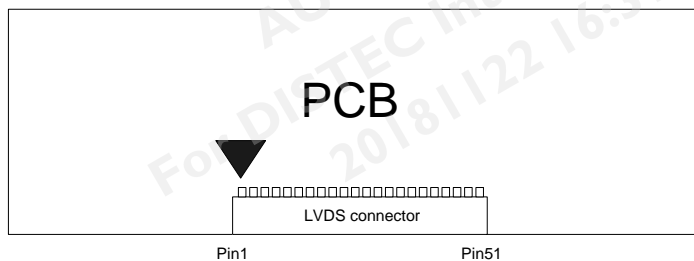

Note2. Please leave this pin unoccupied. It can not be connected by any signal (Low/GND/High).

Note3. Input control signal threshold voltage definition

Item	Symbol	Min.	Typ.	Max.	Unit
Input High Threshold Voltage	VIH	2.7	-	3.6	V
Input Low Threshold Voltage	VIL	0	-	0.6	V

**Note4. Local Dimming Enable Pin**

LD_EN	Mode
H	Enable
L or OPEN	Disable

**Input equivalent impedance of Local Dimming Enable Pin**

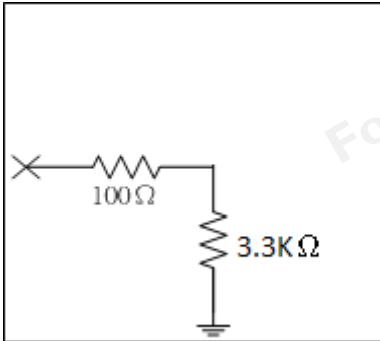

**Note5. Please leave this pin unoccupied or connect to ground. It can not be connected by any signal (Low/High).**

### 3.3 Input Data Format

#### 3.3.1 Data mapping

##### 3.3.1.1 LVDS

#### LVDS Option for 10bit

#### ■ LVDS Option JEIDA

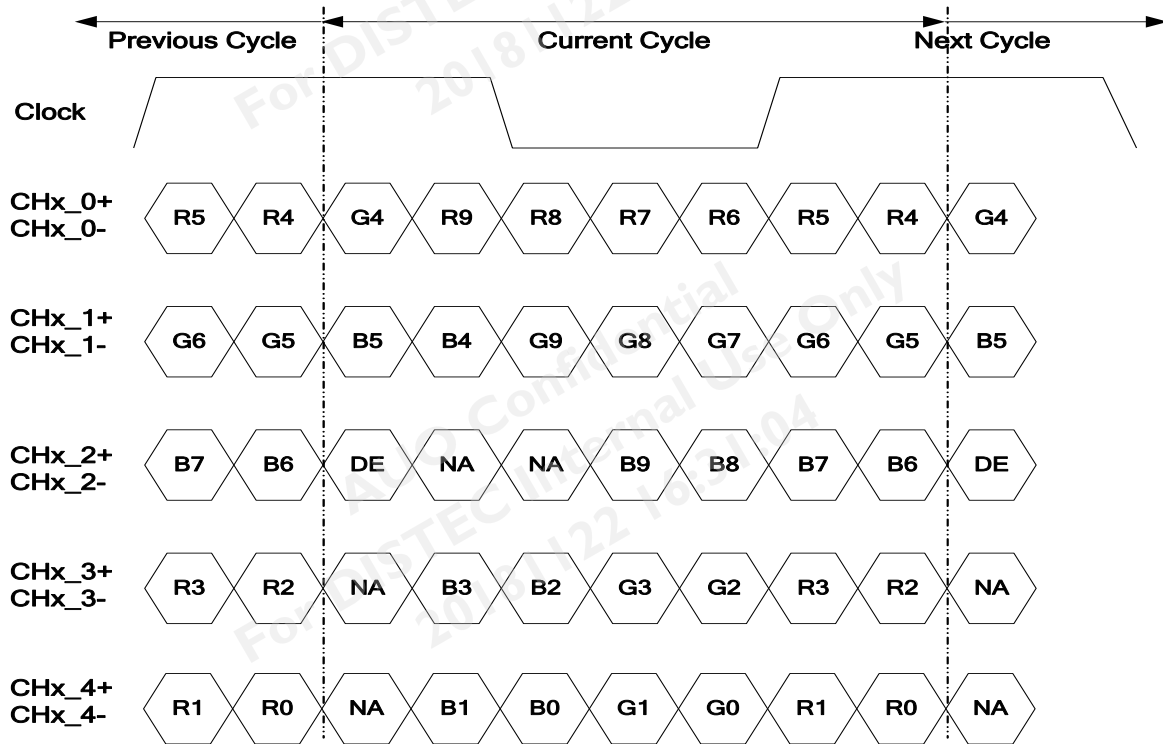

Note: x = 1, 2, 3, 4...

**3.3.2 Color Input Data Reference**

The brightness of each primary color (red, green and blue) is based on the 10 bit gray scale data input for the color; the higher the binary input, the brighter the color. The table below provides a reference for color versus data input.

**COLOR DATA REFERENCE**

Color		Input Color Data																													
		RED										GREEN										BLUE									
		MSB					LSB					MSB					LSB					MSB					LSB				
		R9	R8	R7	R6	R5	R4	R3	R2	R1	R0	G9	G8	G7	G6	G5	G4	G3	G2	G1	G0	B9	B8	B7	B6	B5	B4	B3	B2	B1	B0
Basic Color	Black	0	0	0	0	0	0	0	0	0	0	0	0	0	0	0	0	0	0	0	0	0	0	0	0	0	0	0	0	0	0
	Red(1023)	1	1	1	1	1	1	1	1	1	1	0	0	0	0	0	0	0	0	0	0	0	0	0	0	0	0	0	0	0	0
	Green(1023)	0	0	0	0	0	0	0	0	0	0	1	1	1	1	1	1	1	1	1	1	0	0	0	0	0	0	0	0	0	0
	Blue(1023)	0	0	0	0	0	0	0	0	0	0	0	0	0	0	0	0	0	0	0	0	1	1	1	1	1	1	1	1	1	1
	Cyan	0	0	0	0	0	0	0	0	0	0	1	1	1	1	1	1	1	1	1	1	1	1	1	1	1	1	1	1	1	1
	Magenta	1	1	1	1	1	1	1	1	1	1	0	0	0	0	0	0	0	0	0	0	1	1	1	1	1	1	1	1	1	1
	Yellow	1	1	1	1	1	1	1	1	1	1	1	1	1	1	1	1	1	1	1	1	0	0	0	0	0	0	0	0	0	0
	White	1	1	1	1	1	1	1	1	1	1	1	1	1	1	1	1	1	1	1	1	1	1	1	1	1	1	1	1	1	1
R	RED(000)	0	0	0	0	0	0	0	0	0	0	0	0	0	0	0	0	0	0	0	0	0	0	0	0	0	0	0	0	0	
	RED(001)	0	0	0	0	0	0	0	0	1	0	0	0	0	0	0	0	0	0	0	0	0	0	0	0	0	0	0	0	0	
	----																														
	RED(1022)	1	1	1	1	1	1	1	1	1	0	0	0	0	0	0	0	0	0	0	0	0	0	0	0	0	0	0	0	0	0
	RED(1023)	1	1	1	1	1	1	1	1	1	1	0	0	0	0	0	0	0	0	0	0	0	0	0	0	0	0	0	0	0	0
G	GREEN(000)	0	0	0	0	0	0	0	0	0	0	0	0	0	0	0	0	0	0	0	0	0	0	0	0	0	0	0	0	0	
	GREEN(001)	0	0	0	0	0	0	0	0	0	0	0	0	0	0	0	0	0	0	1	0	0	0	0	0	0	0	0	0	0	
	----																														
	GREEN(1022)	0	0	0	0	0	0	0	0	0	1	1	1	1	1	1	1	1	1	0	0	0	0	0	0	0	0	0	0	0	
	GREEN(1023)	0	0	0	0	0	0	0	0	0	1	1	1	1	1	1	1	1	1	1	0	0	0	0	0	0	0	0	0	0	
B	BLUE(000)	0	0	0	0	0	0	0	0	0	0	0	0	0	0	0	0	0	0	0	0	0	0	0	0	0	0	0	0	0	
	BLUE(001)	0	0	0	0	0	0	0	0	0	0	0	0	0	0	0	0	0	0	0	0	0	0	0	0	0	0	0	0	1	
	----																														
	BLUE(1022)	0	0	0	0	0	0	0	0	0	0	0	0	0	0	0	0	0	0	0	1	1	1	1	1	1	1	1	1	0	
	BLUE(1023)	0	0	0	0	0	0	0	0	0	0	0	0	0	0	0	0	0	0	0	1	1	1	1	1	1	1	1	1	1	

### 3.4 Signal Timing Specification

#### 3.4.1 Input Timing

This is the signal timing required at the input of the user connector. All of the interface signal timing should be satisfied with the following specifications for its proper operation.

##### 3.4.1.1 Timing table

Timing Table (DE only Mode)

Signal	Item	Symbol	Min.	Typ.	Max	Unit
Vertical Section	Period	Tv	1100	1125	1480	Th
	Active	Tdisp (v)	1080			Th
	Blanking	Tblk (v)	20	45	400	Th
Horizontal Section	Period	Th	1030	1100	1325	Tclk
	Active	Tdisp (h)	960			Tclk
	Blanking	Tblk (h)	70	140	365	Tclk
Clock	Frequency	Fclk=1/Tclk	50	74.25	82	MHz
Vertical Frequency	Frequency	Fv	47	60	63	Hz
Horizontal Frequency	Frequency	Fh	60	67.5	73	KHz

Notes:

(1) Display position is specific by the rise of DE signal only.

Horizontal display position is specified by the rising edge of 1<sup>st</sup> DCLK after the rise of 1<sup>st</sup> DE, is displayed on the left edge of the screen.

(2) Vertical display position is specified by the rise of DE after a “Low” level period equivalent to eight times of horizontal period. The 1<sup>st</sup> data corresponding to one horizontal line after the rise of 1<sup>st</sup> DE is displayed at the top line of screen.

(3) If a period of DE “High” is less than 1920 DCLK or less than 1080 lines, the rest of the screen displays black.

(4) The display position does not fit to the screen if a period of DE “High” and the effective data period do not synchronize with each other.

**3.4.1.2 Signal Timing Waveforms**

1920x1080x60Hz

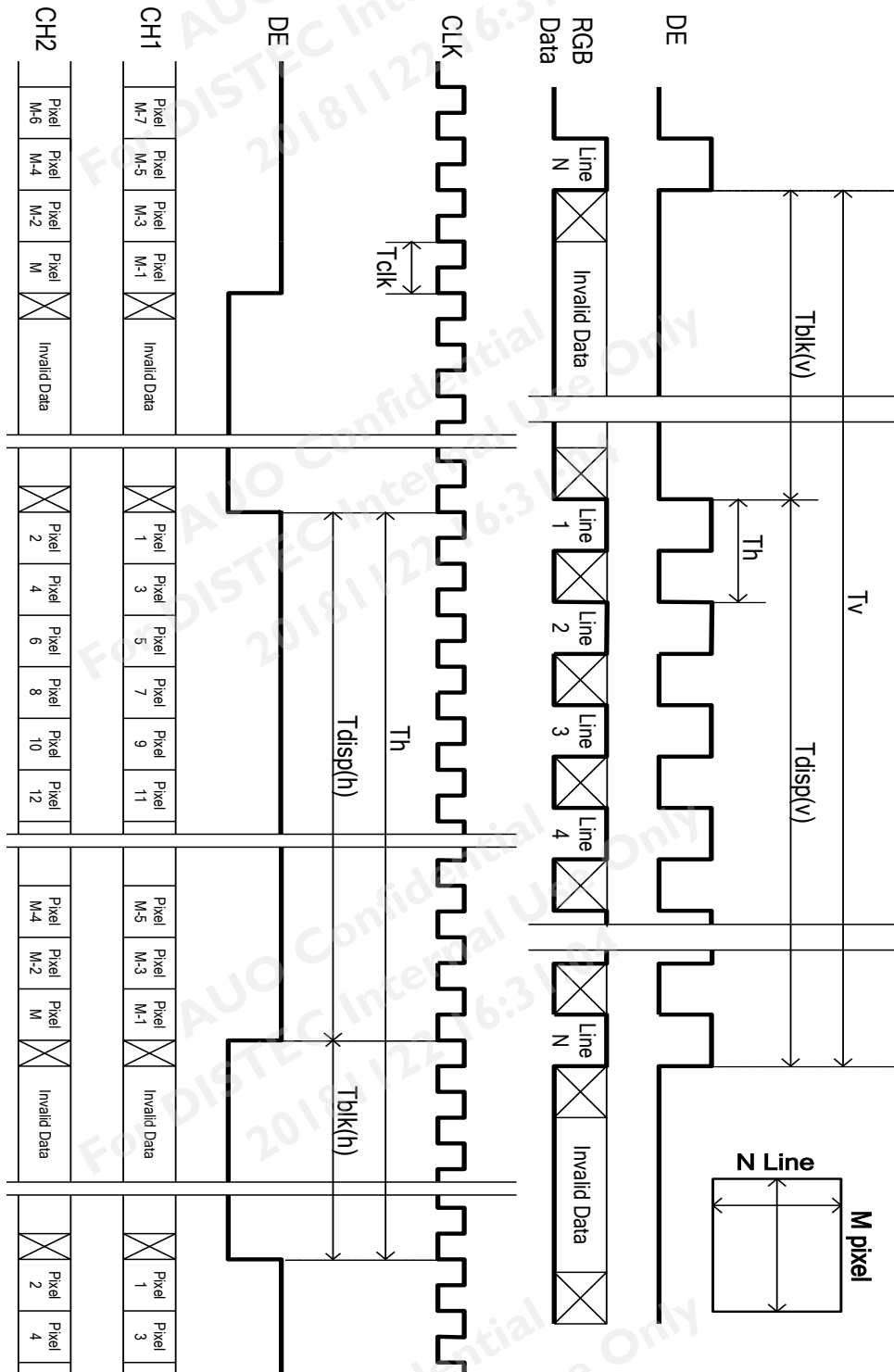

**3.4.2 Input interface characteristics**

**3.4.2.1 LVDS**

Parameter		Symbol	Value			Unit	Note
			Min.	Typ.	Max		
LVDS Interface	Input Differential Voltage	$ V_{ID} $	200	400	600	mV <sub>DC</sub>	1
	Differential Input High Threshold Voltage	$V_{TH}$	+100	--	+300	mV <sub>DC</sub>	1
	Differential Input Low Threshold Voltage	$V_{TL}$	-300	--	-100	mV <sub>DC</sub>	1
	Input Common Mode Voltage	$V_{ICM}$	1.1	1.25	1.4	V <sub>DC</sub>	1
	Input Channel Pair Skew Margin	$t_{SKEW (CP)}$	-500	--	+500	ps	2
	Input Channel Pair Skew Margin (only for M'Star MST7428BB)	$t_{SKEW (CP)}$	-400	--	+400	ps	2
	Receiver Clock : Spread Spectrum Modulation range	Fclk_ss	Fclk -3%	--	Fclk +3%	MHz	3
	Receiver Clock : Spread Spectrum Modulation frequency	Fss	30	--	200	KHz	3
	Receiver Data Input Margin Fclk = 85 MHz Fclk = 65 MHz	tRMG	-0.4 -0.5	-- --	0.4 0.5	ns	8

Note1.  $V_{ICM} = 1.25V$

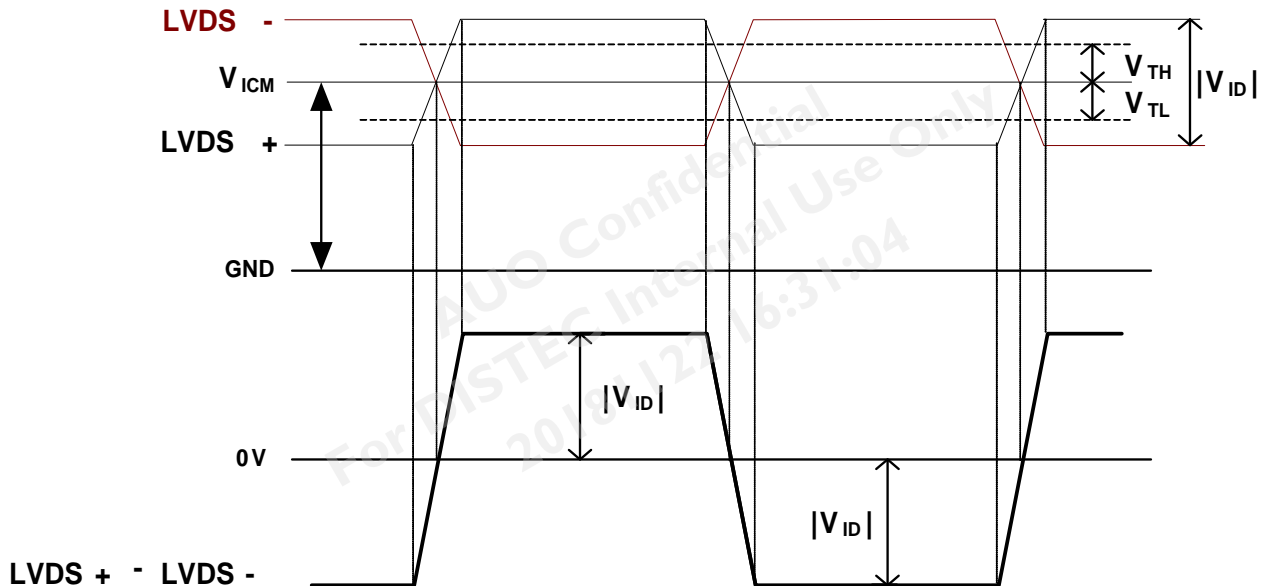

Note2. Input Channel Pair Skew Margin

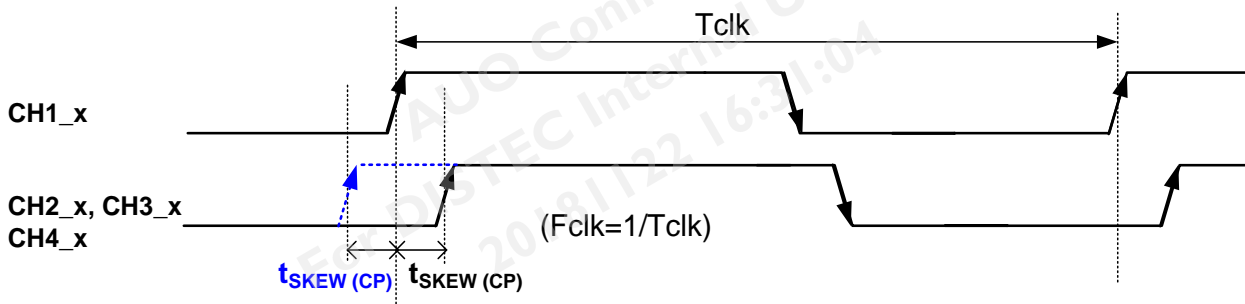

Note3. LVDS Receiver Clock SSCG (Spread spectrum clock generator) is defined as below figures.

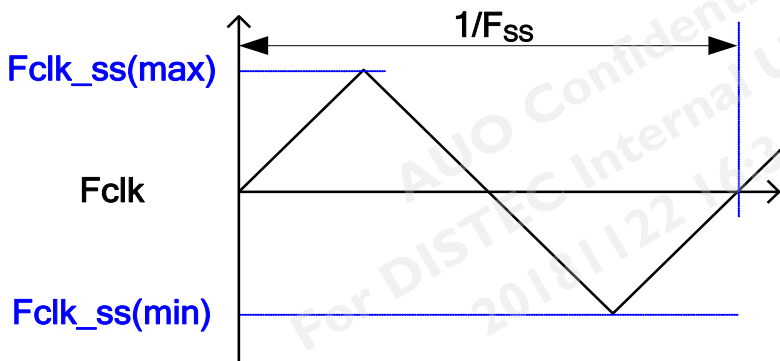



**Note4. Receiver Data Input Margin**

Parameter	Symbol	Rating			Unit	Note
		Min	Type	Max		
Input Clock Frequency	Fclk	Fclk (min)	--	Fclk (max)	MHz	$T=1/Fclk$
Input Data Position0	tRIP1	- tRMG	0	tRMG	ns	
Input Data Position1	tRIP0	$T/7- tRMG $	$T/7$	$T/7+ tRMG $	ns	
Input Data Position2	tRIP6	$2T/7- tRMG $	$2T/7$	$2T/7+ tRMG $	ns	
Input Data Position3	tRIP5	$3T/7- tRMG $	$3T/7$	$3T/7+ tRMG $	ns	
Input Data Position4	tRIP4	$4T/7- tRMG $	$4T/7$	$4T/7+ tRMG $	ns	
Input Data Position5	tRIP3	$5T/7- tRMG $	$5T/7$	$5T/7+ tRMG $	ns	
Input Data Position6	tRIP2	$6T/7- tRMG $	$6T/7$	$6T/7+ tRMG $	ns	

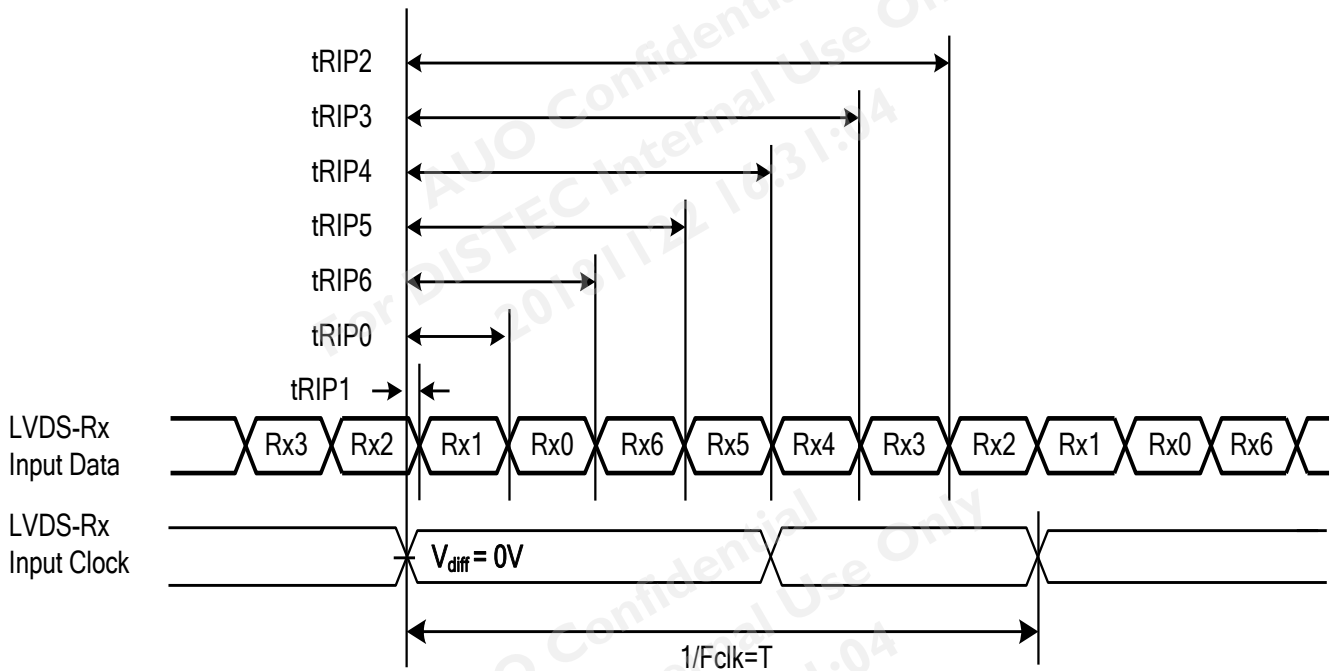

**3.4.3 Power Sequence for LCD**

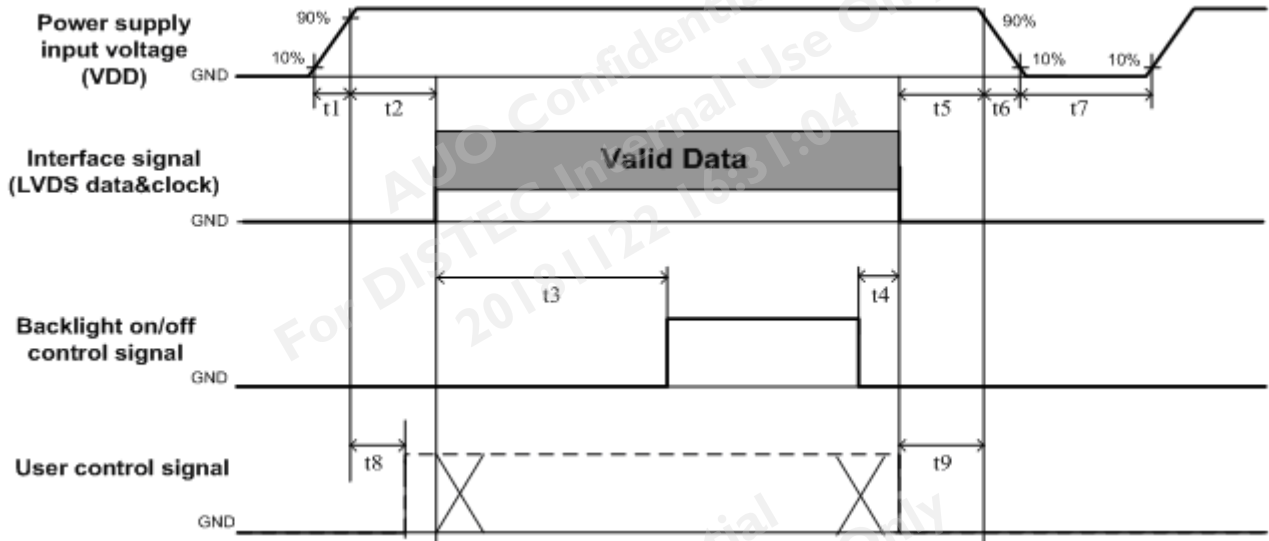

Parameter	Values			Unit
	Min.	Type.	Max.	
t1	0.4	---	30	ms
t2	0.1	---	50	ms
t3	450	---	---	ms
t4	0 <sup>*1</sup>	---	---	ms
t5	0	---	---	ms
t6	---	---	--- <sup>*2</sup>	ms
t7	500	---	---	ms
t8	20 <sup>*3</sup>	---	50	ms
t9	0	---	---	ms

Note:

- (1) t4=0 : concern for residual pattern before BLU turn off.
- (2) t6 : voltage of VDD must decay smoothly after power-off. (customer system decide this value)
- (3) When user control signal is N.C. (no connection), opened in Transmitted end, t8 timing spec can be negligible.

**3.5 Backlight Specification**

**3.5.1 Electrical specification**

Item	Symbol	Condition	Min	Typ	Max	Unit	Note	
1 Power Supply Input Voltage	V <sub>DDB</sub>	-	22.8	24	25.2	V	-	
2 Power Supply Input Current	I <sub>DDB</sub>	V <sub>DDB</sub> =24V	-	18	19.8	A	1	
3 Power Consumption	P <sub>DDB</sub>	V <sub>DDB</sub> =24V	-	432	475.2	Watt	1	
4 Inrush Current	I <sub>RUSH</sub>	V <sub>DDB</sub> =24V	-	-	25	A	2	
5 Control signal voltage	V <sub>Signal</sub>	V <sub>DDB</sub> =24V	Hi	2	-	3.3	V	-
			Low	-0.3	-	0.8		3
6 Control signal current	I <sub>Signal</sub>	V <sub>DDB</sub> =24V	-	-	1.5	mA	-	
7 External PWM Duty ratio (input duty ratio)	D_EPWM	V <sub>DDB</sub> =24V	5	-	100	%	4	
8 External PWM Frequency	F_EPWM	V <sub>DDB</sub> =24V	90	180	240	Hz	4	
9 DET status signal	DET	V <sub>DDB</sub> =24V	Open Collector			V	5	
			Hi	0	-	0.8	V	5
10 Input Impedance	R <sub>in</sub>	V <sub>DDB</sub> =24V	300	-	-	Kohm	-	

Note 1: Dimming ratio= 100%, ( Ta=25±5°C, Turn on for 45minutes )

Note 2: MAX input current while DB turn on, measurement condition V<sub>DDB</sub> rising time=20ms(V<sub>DDB</sub>: 10%~90%)

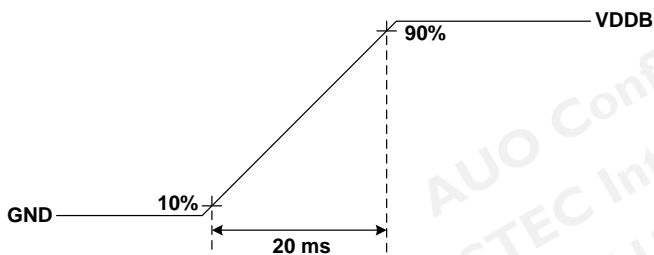

Note 3: When BLU off ( V<sub>DDB</sub> = 24V , V<sub>BLON</sub> = 0V ) , I<sub>DDB</sub> (max) = 0.1A

Note 4: Less than 5% dimming control is functional well and no backlight shutdown happened

Note 5: Normal: 0~0.8V ; Abnormal : Open collector

### 3.5.2 Input Pin Assignment

LED DB connector: CI0114M1HRL-NH(CviLux) or equivalent  
CI0112M1HRL-NH(CviLux) or equivalent

Pin	Symbol	Description	Note
1	VDDB	Power Supply Input Voltage	
2	VDDB	Power Supply Input Voltage	
3	VDDB	Power Supply Input Voltage	
4	VDDB	Power Supply Input Voltage	
5	VDDB	Power Supply Input Voltage	
6	GND	Ground	
7	GND	Ground	
8	GND	Ground	
9	GND	Ground	
10	GND	Ground	
11	DET	BLU status detection:	1
12	VBLOK	BLU On-Off control:	2,3
13	NC	NC	4
14	PDIM	External PWM	2, 5

Pin	Symbol	Description	Note
1	VDDDB	Power Supply Input Voltage	
2	VDDDB	Power Supply Input Voltage	
3	VDDDB	Power Supply Input Voltage	
4	VDDDB	Power Supply Input Voltage	
5	VDDDB	Power Supply Input Voltage	
6	GND	Ground	
7	GND	Ground	
8	GND	Ground	
9	GND	Ground	
10	GND	Ground	
11	NC	NC	4
12	NC	NC	4

Pin	Symbol	Description	Note
1	VDDDB	Power Supply Input Voltage	
2	VDDDB	Power Supply Input Voltage	
3	VDDDB	Power Supply Input Voltage	
4	VDDDB	Power Supply Input Voltage	
5	VDDDB	Power Supply Input Voltage	
6	GND	Ground	
7	GND	Ground	
8	GND	Ground	
9	GND	Ground	
10	GND	Ground	
11	NC	NC	4
12	NC	NC	4

Pin	Symbol	Description	Note
1	VDDB	Power Supply Input Voltage	
2	VDDB	Power Supply Input Voltage	
3	VDDB	Power Supply Input Voltage	
4	VDDB	Power Supply Input Voltage	
5	VDDB	Power Supply Input Voltage	
6	GND	Ground	
7	GND	Ground	
8	GND	Ground	
9	GND	Ground	
10	GND	Ground	
11	NC	NC	4
12	NC	NC	4

**Note1. DET status**

DET	BLU status
0 ~ 0.8V	Normal
Open collector	Abnormal

Recommend pull high R > 10K ohm, pull high voltage VDD = 3.3V

**Note2. input control signal threshold voltage definition**

Item	Symbol	Min.	Typ.	Max.	Unit
Input High Threshold Voltage	VIH	2	-	3.3	V
Input Low Threshold Voltage	VIL	-0.3	-	0.8	V

**Note3. VBLON**

Mode selection

WP	Note
H or OPEN	BL On
L	BL Off

**Note4. Please leave this pin unoccupied. It can not be connected by any signal (Low/GND/High).**

**Note5. PDIM**

PWM Dimming range:



**Performance guaranteed dimming range: 0%, 5~100%**

IF External PWM function less than 5% dimming ratio, Judge condition as below:

- (1) Backlight module must be lighted ON normally.
- (2) All protection function must work normally.
- (3) Uniformity and flicker could not be guaranteed

### 3.5.3 Power Sequence for Backlight

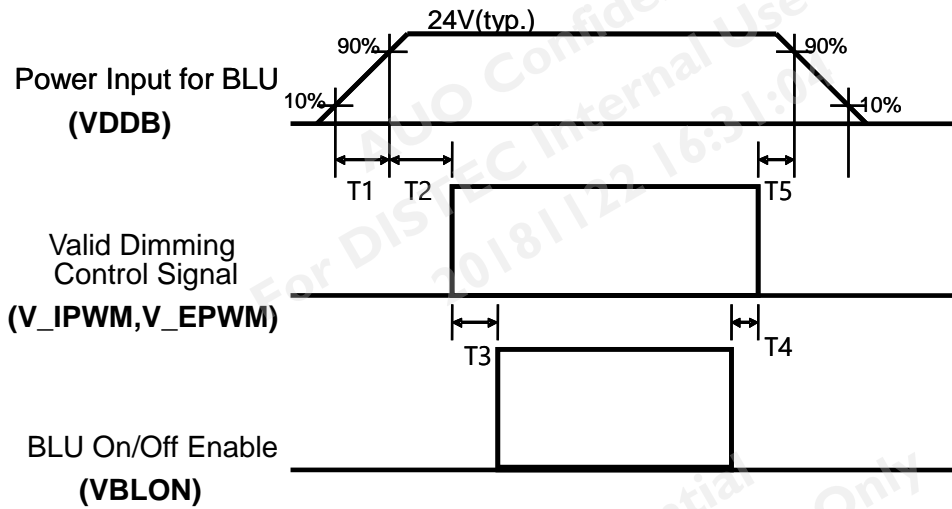

#### Dip condition

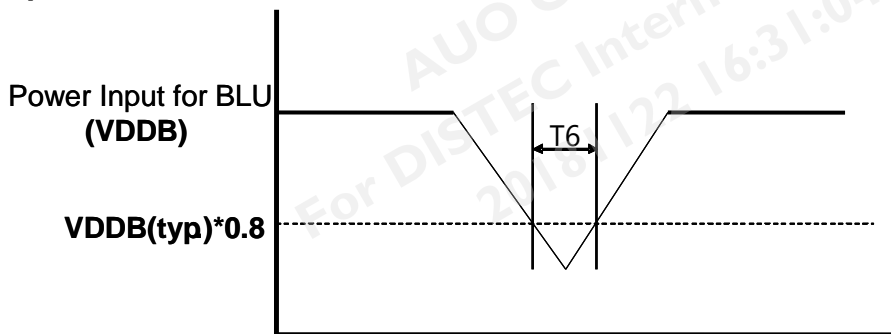

Parameter	Min	Typ	Max	Units
T1	20	-	-	ms <sup>*1</sup>
T2	250	-	-	ms
T3	200	-	-	ms
T4	0	-	-	ms
T5	0	-	-	ms
T6	-	-	1000	ms <sup>*2</sup>

Note:1. T1 describes rising time of 0V to 24V and this parameter does not applied at restarting time. Even though T1 is over the specified value, there is no problem if I2t spec of fuse is satisfied.

Note:2. T6 describes VDDB dip condition and VDDB couldn't lower than 10% VDDB.



**3.5.4 LED Operating Life Time**

Parameter	Symbol	Value			Unit	Note
		Min.	Typ.	Max		
Backlight Operating Life Time(MTTF)		50000	60000	-	Hour	1

**Note:**

- The lifetime (MTTF) is defined as the time which luminance of LED is 50% compared to its original value.  
[Operating condition: Continuous operating at Ta = 25±2°C, for single lamp/LED only]

AUO Confidential  
For DISTEC Internal Use Only  
2018/11/22 16:31:04

AUO Confidential  
For DISTEC Internal Use Only  
2018/11/22 16:31:04

AUO Confidential  
For DISTEC Internal Use Only  
2018/11/22 16:31:04

**4. Reliability Test Items**

	Test Item	Q'ty	Condition
1	High temperature storage test	3	60°C, 500hrs
2	Low temperature storage test	3	-20°C, 500hrs
3	High temperature operation test	3	50°C, 500hrs
4	Low temperature operation test	3	-5°C, 500hrs
5	Vibration test (With carton)	1( PKG)	Random wave (1.04Grms 2~200Hz) Duration : X,Y,Z 20min per axes
6	Drop test (With carton)	1( PKG)	Height: 25.4 cm Direction: Only bottom flat twice (ASTMD4169-I)

## **5. International Standard**

### **5.1. Safety**

- (1) UL 60950-1; Standard for Safety of Information Technology Equipment Including electrical Business Equipment.
- (2) IEC 60950-1; Standard for Safety of International Electrotechnical Commission
- (3) EN 60950-1; European Committee for Electrotechnical Standardization (CENELEC), EUROPEAN STANDARD for Safety of Information Technology Equipment Including Electrical Business Equipment.

### **5.2. EMC**

- (1) ANSI C63.4 “Methods of Measurement of Radio-Noise Emissions from Low-Voltage Electrical and Electrical Equipment in the Range of 9kHz to 40GHz. “American National standards Institute(ANSI), 1992
- (2) C.I.S.P.R “Limits and Methods of Measurement of Radio Interface Characteristics of Information Technology Equipment.” International Special committee on Radio Interference.
- (3) EN 55022 “Limits and Methods of Measurement of Radio Interface Characteristics of Information Technology Equipment.” European Committee for Electrotechnical Standardization. (CENELEC), 1998

## 6. Packing

### 6.1. Definition of Label

#### A. Panel Label:



\*XXXXXXXXXXXX-XXXXXX\*

Panel Unique ID

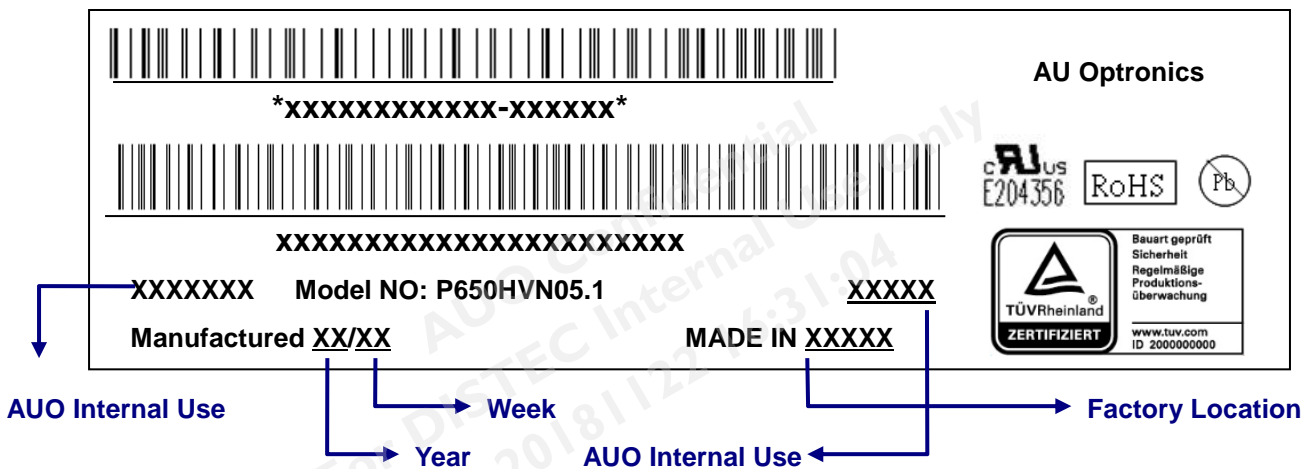
AUO Internal Use



#### Green mark description

- (1) For Pb Free Product, AUO will add  for identification.
- (2) For RoHs compatible products, AUO will add  for identification.

Note: The green Mark will be present only when the green documents have been ready by AUO internal green team. (definition of green design follows the AUO green design checklist.)

#### B. Carton Label:

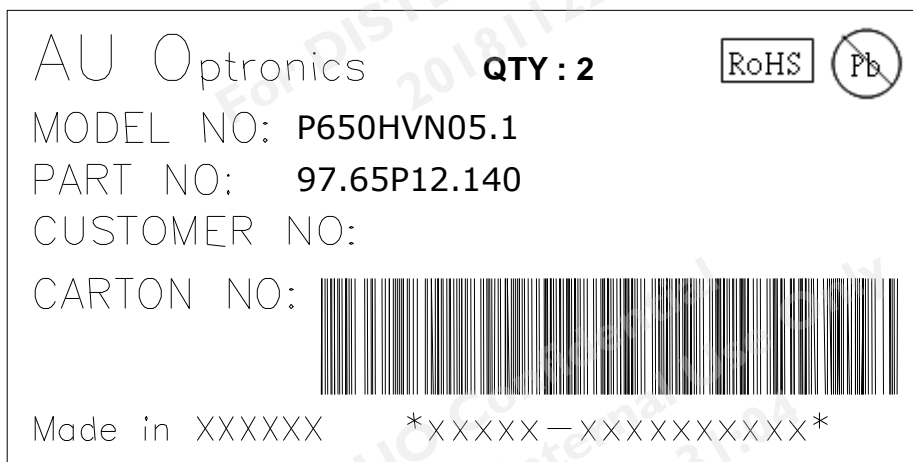

6.2. Packing Methods

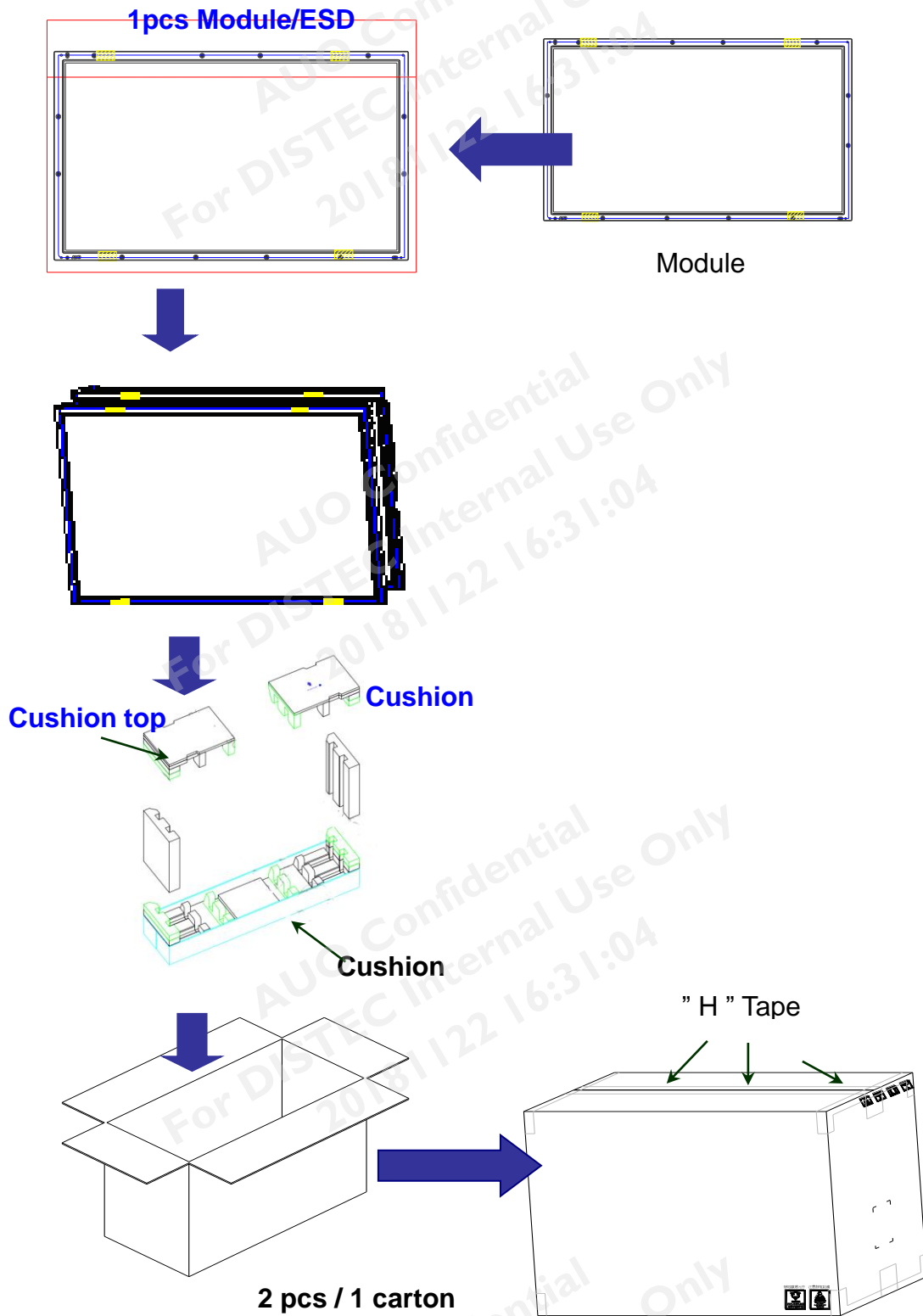

**6.3. Pallet and Shipment Information**

	Item	Specification			Packing Remark
		Qty.	Dimension	Weight (kg)	
1	Packing Box	2 pcs/box	1564(L)mm*383(W)mm*982 (H)mm	72.6	估單片 30kg
2	Pallet	1	1660(L)mm*1150(W)mm*138(H)mm	33.8	
3	Boxes per Pallet	3 boxes/Pallet (By Air) ; 3 Boxes/Pallet (By Sea 40ft Normal) ;			
4	Panels per Pallet	6pcs/pallet(By Air) ; 6pcs/Pallet (By Sea 40ft Normal)			
5	Pallet after packing	6 (by Air)	1660(L)mm*1150(W)mm*982(H)mm	251.6 (by Air)	概估
		12 (by Sea)	1660(L)mm*1150(W)mm*1964(H)mm	503.2 (by Sea)	40ft HQ 概估

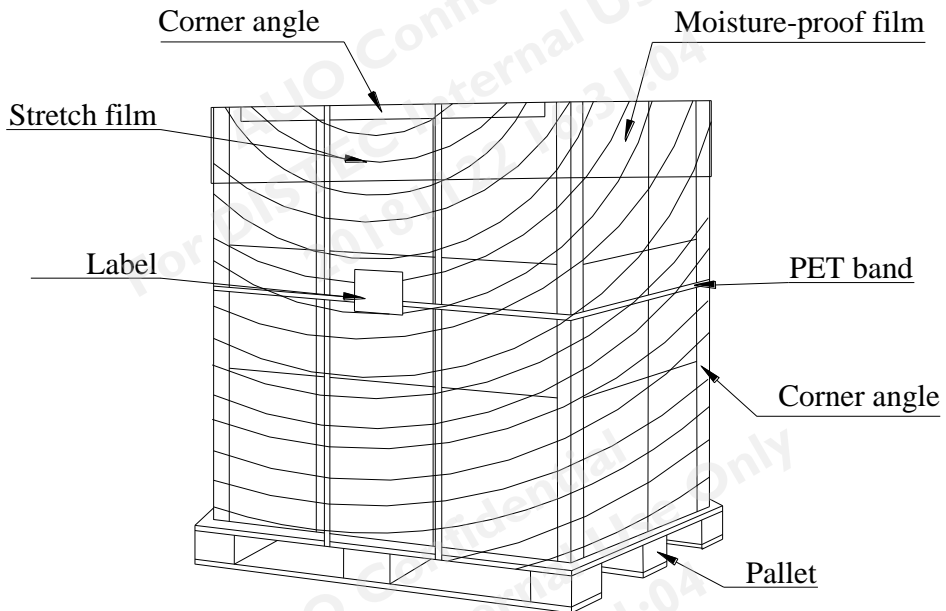

## **7. Precautions**

Please pay attention to the followings when you use this TFT LCD module.

### **7.1. Mounting Precautions**

- (1) You must mount a module using holes arranged in four corners or four sides.
- (2) You should consider the mounting structure so that uneven force (ex. twisted stress) is not applied to module. And the case on which a module is mounted should have sufficient strength so that external force is not transmitted directly to the module.
- (3) Please attach the surface transparent protective plate to the surface in order to protect the polarizer. Transparent protective plate should have sufficient strength in order to resist external force.
- (4) You should adopt radiation structure to satisfy the temperature specification.
- (5) Acetic acid type and chlorine type materials for the cover case are not desirable because the former generates corrosive gas of attacking the polarizer at high temperature and the latter cause circuit broken by electro-chemical reaction.
- (6) Do not touch, push or rub the exposed polarizer with glass, tweezers or anything harder than HB pencil lead. And please do not rub with dust clothes with chemical treatment. Do not touch the surface of polarizer for bare hand or greasy cloth. (Some cosmetics are detrimental to the polarizer.)
- (7) When the surface becomes dusty, please wipe gently with absorbent cotton or other soft materials like chamois soaks with petroleum benzene. Normal-hexane is recommended for cleaning the adhesives used to attach front/ rear polarizer. Do not use acetone, toluene and alcohol because they cause chemical damage to the polarizer.
- (8) Wipe off saliva or water drops as soon as possible. Their long time contact with polarizer causes deformations and color fading.
- (9) Do not open the case because inside circuits do not have sufficient strength.
- (10) To keep display functional well as a digital signage application, especially the component of TFT is very sensitive with sunlight, it is necessary to set up blocking device protecting panel from radiation of ambient environment.

### **7.2. Operating Precautions**

- (1) The spike noise causes the mis-operation of circuits. It should be lower than following voltage:  
 $V = \pm 200\text{mV}$  (Over and under shoot voltage)
- (2) Response time depends on the temperature. (In lower temperature, it becomes longer..)
- (3) Brightness depends on the temperature. (In lower temperature, it may become lower.) And in lower temperature, response time (required time that brightness is stable after turned on) becomes longer.
- (4) Be careful for condensation at sudden temperature change. Condensation makes damage to polarizer or electrical contacted parts. And after fading condensation, smear or spot will occur.

- (5) When fixed patterns are displayed for a long time, remnant image is likely to occur.
- (6) Module has high frequency circuits. Sufficient suppression to the electromagnetic interference shall be done by system manufacturers. Grounding and shielding methods may be important to minimize the interface.

### 7.3. Operating Condition for Public Information Display

The device listed in the product specification is designed and manufactured for PID (Public Information Display) application. To optimize module's lifetime and function, below operating usages are required.

- (1) Normal operating condition
  - A. Operating temperature: 0~50°C
  - B. Operating humidity: 10~90%
  - C. Display pattern: dynamic pattern (Real display).  
Note) Long-term static display would cause image sticking.
- (1) Operation usage to protect against image sticking due to long-term static display.
  - A. Suitable operating time: under 20 hours a day.  
(\* The moving picture can be allowed for 24 hours a day)
  - B. Liquid Crystal refresh time is required. Cycling display between 5 minutes' information (static) display and 10 seconds' moving image.
  - C. Periodically change background and character (image) color.
  - D. Avoid combination of background and character with large different luminance.
- (2) Periodically adopt one of the following actions after long time display.
  - A. Running the screen saver (motion picture or black pattern)
  - B. Power off the system for a while
- (3) LCD system is required to place in well-ventilated environment. Adapting active cooling system is highly recommended.
- (4) Product reliability and functions are only guaranteed when the product is used under right operation usages. If product will be used in extreme conditions, such as high temperature/humidity, display stationary patterns, or long operation time etc..., it is strongly recommended to contact AUO for filed application engineering advice. Otherwise, its reliability and function may not be guaranteed. Extreme conditions are commonly found at airports, transit stations, banks, stock market and controlling systems.

### 7.4. Electrostatic Discharge Control

Since a module is composed of electronic circuits, it is not strong to electrostatic discharge. Make certain that treatment persons are connected to ground through wristband etc. And don't touch interface pin directly.

### 7.5. Precautions for Strong Light Exposure

Strong light exposure causes degradation of polarizer and color filter.



## 7.6. Storage

When storing modules as spares for a long time, the following precautions are necessary.

- (1) Store them in a dark place. Do not expose the module to sunlight or fluorescent light. Keep the temperature between 5°C and 35°C at normal humidity.
- (2) The polarizer surface should not come in contact with any other object. It is recommended that they be stored in the container in which they were shipped.
- (3) Storage condition is guaranteed under packing conditions.
- (4) The phase transition of Liquid Crystal in the condition of the low or high storage temperature will be recovered when the LCD module returns to the normal condition.

## 7.7. Handling Precautions for Protection Film

- (1) The protection film is attached to the bezel with a small masking tape. When the protection film is peeled off, static electricity is generated between the film and polarizer. This should be peeled off slowly and carefully by people who are electrically grounded and with well ion-blown equipment or in such a condition, etc.
- (2) When the module with protection film attached is stored for a long time, sometimes there remains a very small amount of glue still on the bezel after the protection film is peeled off.
- (3) You can remove the glue easily. When the glue remains on the bezel or its vestige is recognized, please wipe them off with absorbent cotton waste or other soft material like chamois soaked with normal-hexane.

Our company network supports you worldwide with offices in Germany, Austria, Switzerland, the UK and the USA. For more information please contact:

## Headquarters

### Germany



#### FORTEC Elektronik AG

Augsburger Str. 2b  
82110 Germering

Phone: +49 89 894450-0  
E-Mail: [info@fortecag.de](mailto:info@fortecag.de)  
Internet: [www.fortecag.de](http://www.fortecag.de)

## Fortec Group Members

### Austria



#### Distec GmbH Office Vienna

Nuschinggasse 12  
1230 Wien

Phone: +43 1 8673492-0  
E-Mail: [info@distec.de](mailto:info@distec.de)  
Internet: [www.distec.de](http://www.distec.de)

### Germany



#### Distec GmbH

Augsburger Str. 2b  
82110 Germering

Phone: +49 89 894363-0  
E-Mail: [info@distec.de](mailto:info@distec.de)  
Internet: [www.distec.de](http://www.distec.de)

### Switzerland



#### ALTRAC AG

Bahnhofstraße 3  
5436 Würenlos

Phone: +41 44 7446111  
E-Mail: [info@altrac.ch](mailto:info@altrac.ch)  
Internet: [www.altrac.ch](http://www.altrac.ch)

### United Kingdom



#### Display Technology Ltd.

Osprey House, 1 Osprey Court  
Hichingbrooke Business Park  
Huntingdon, Cambridgeshire, PE29 6FN

Phone: +44 1480 411600  
E-Mail: [info@displaytechnology.co.uk](mailto:info@displaytechnology.co.uk)  
Internet: [www.displaytechnology.co.uk](http://www.displaytechnology.co.uk)

### USA



#### Apollo Display Technologies, Corp.

87 Raynor Avenue,  
Unit 1 Ronkonkoma,  
NY 11779

Phone: +1 631 5804360  
E-Mail: [info@apolloDisplays.com](mailto:info@apolloDisplays.com)  
Internet: [www.apolloDisplays.com](http://www.apolloDisplays.com)