



OUR GLOBAL
COMPETENCE
CENTRES

 APOLLO DISPLAY
TECHNOLOGIES



 DISTEC



 DISPLAY
TECHNOLOGY



Datasheet

AUO

D(&\$ < JB\$ ' '%



WÜEGEG

Model Name: P430QVN02.0

Issue Date: 2019/05/21

() Preliminary Specifications

(*) Final Specifications

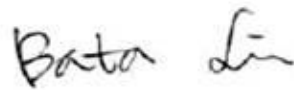
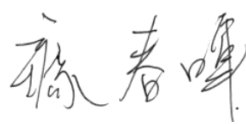
Customer Signature	Date	AUO	Date
Approved By		Approval By PM Director Kelly Kao 	
Note		Reviewed By RD Director Eugene CC Chen 	
		Reviewed By Project Leader Bata Lin 	
		Prepared By PM Bryan Chu 	

Contents

1. General Description	4
1.1. Display Characteristics.....	4
1.2. Optical Characteristics.....	5
1.3. Mechanical Characteristics.....	8
1.3.1. Placement Suggestions.....	8
2. Absolute Maximum Ratings	12
3. Electrical Specification	13
3.1. Electrical Characteristics.....	13
3.1.1. DC Characteristics ($T_a = 25 \pm 2^\circ\text{C}$).....	13
3.1.2. AC Characteristics ($T_a = 25 \pm 2^\circ\text{C}$).....	14
3.1.3. Driver Characteristics.....	14
3.1.4. TCON Characteristics.....	14
3.2. Interface Connections.....	18
3.3. Signal Timing Specification.....	21
3.4. Color Input Data Reference.....	22
3.5. Power Sequence for LCD.....	23
3.6. Backlight Specification.....	24
3.6.1. Electrical specification ($T_a = 25 \pm 2^\circ\text{C}$).....	24
3.6.2. Input Pin Assignment.....	25
3.6.3. Power Sequence for Backlight.....	26
3.6.4. LED Operating Life Time.....	27
4. Reliability Test Items	28
5. International Standard	29
5.1. Safety.....	29
5.2. EMC.....	29
6. Packing	30
6.1. Definition of Label.....	30
6.2. Packing Methods.....	31
6.3. Pallet and Shipment Information.....	32
7. Precautions	33
7.1. Mounting Precautions.....	33
7.2. Operating Precautions.....	33
7.3. Operating Condition for Public Information Display.....	34
7.4. Electrostatic Discharge Control.....	34
7.5. Precautions for Strong Light Exposure.....	34
7.6. Storage.....	35
7.7. Handling Precautions for Protection Film.....	35

Record of Revision

Version	Date	Page	Description
0.0	2016/06/21		1 st release
1.0	2016/08/29	13	Modify "DC Characteristics" table
		14	Modify "AC Characteristics" table
		15	Modify "Note2. test condition"
		24	Modify "Power Sequence for LCD"
1.1	2016/12/19	35	Add item (2) in "Precautions for Strong Light Exposure"
2.0	2017/02/06	4	Modify "Surface Treatment Note" Haze = 11% → Haze = 44%
	2017/02/06	8	Modify "Depth (Dmax)" 25.2 → 26.9mm
	2017/02/06	8	Modify "Weight" 9000 → 10640g
2.1	2017/06/13	4	Modify "Outline Dimension" 963.7(H) x 552.0(V) x 25.2(D) → 26.9(D)
	2017/06/13	4	Modify "Bezel Opening" 954.8(H) x 543.1(V) → 945.9(H) x 534.2(V)
	2017/06/13	29	Modify "Shock test" 50G ,20ms ±X,Y,Z axis → 50G ,11ms ±X,Y,Z axis
2.2	2017/10/31	9	Modify 2D drawing
		10	Modify 2D drawing
		11	Modify 2D drawing
2.3	2018/11/6	25	Modify "Inrush Current" and "External PWM Frequency"
2.4	2019/4/3	4	Correct "General Description"
		11	Modify "Note2 A17~A18 M4 user hole"
2.5	2019/4/8	34	Operating Condition for Public Information Display
		31,32	Packing Methods
2.6	2019/4/26	5	Update "Contrast Ratio"
2.7	2019/5/21	27	Modify LED lifetime 50000 to 70000 Hour

1. General Description

This specification applies to the 43 inch Color TFT-LCD Module P430QVN02.0. This LCD module has a TFT active matrix type liquid crystal panel 3840x2160 pixels, and diagonal size of 42.5 inch. This module supports 3840x2160 mode. Each pixel is divided into Red, Green and Blue sub-pixels or dots which are arranged in vertical stripes. Gray scale or the brightness of the sub-pixel color is determined with 10-bits gray scale signal for each dot.

The P430QVN02.0 has been designed to apply the V by one interface method. It is intended to support displays where high brightness, wide viewing angle.

* General Information

1.1. Display Characteristics

Items	Specification	Unit	Note
Active Screen Size	42.5	inch	
Display Area	941.184 (H) x 529.416 (V)	mm	
Outline Dimension	963.7(H) x 552.0(V) x 26.9(D)	mm	D: front bezel to DB cover
Driver Element	a-Si TFT active matrix		
Bezel Opening	945.9(H) x 534.2(V)	mm	
Display Colors	10bit	Colors	
Number of Pixels	3,840x2,160	Pixel	
Pixel Pitch	0.2451 (H) x 0.2451 (W)	mm	
Pixel Arrangement	RGB vertical stripe		
Display Operation Mode	Normally Black		
Surface Treatment	Anti-Glare, 3H		Haze = 44%
Rotate Function	Unachievable		Note 1
Display Orientation	Portrait/Landscape Enabled		Note 2

Note 1: Rotate Function refers to LCD display could be able to rotate. This function does not work in this model.

Note 2: Please refer to 5.1 Placement Suggestions.

1.2. Optical Characteristics

Optical characteristics are determined on the back-light of measured unit is 'ON' and stabilized after 45~60 minutes in a dark environment at 25°C. The values are specified at 50cm distance from the LCD surface at a viewing angle of ϕ and θ equal to 0°.

Fig.1 presents additional information concerning the measurement equipment and method.

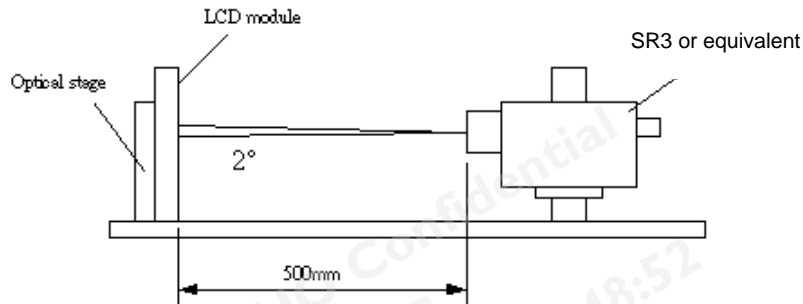

Parameter	Symbol	Values			Unit	Notes
		Min.	Typ.	Max		
Contrast Ratio	CR	3200	4000	--		1
Surface Luminance (White)	$L_{WH}(2D)$	560	700	--	cd/m ²	2
Luminance Variation	$\delta_{WHITE(9P)}$	--	--	1.33		3
Response Time (G to G)	T_Y	--	8	10	ms	4
Color Gamut	NTSC		72		%	
Color Coordinates						
Red	R_X	Typ.-0.03	0.650	Typ.+0.03		
	R_Y		0.336			
Green	G_X		0.310			
	G_Y		0.611			
Blue	B_X		0.150			
	B_Y		0.067			
White	W_X		0.28			
	W_Y		0.29			
Viewing Angle						
x axis, right($\phi=0^\circ$)	θ_r	--	89	--	degree	5
x axis, left($\phi=180^\circ$)	θ_l	--	89	--	degree	
y axis, up($\phi=90^\circ$)	θ_u	--	89	--	degree	
y axis, down ($\phi=270^\circ$)	θ_d	--	89	--	degree	

Note:

1. Contrast Ratio (CR) is defined mathematically as:

$$\text{Contrast Ratio} = \frac{\text{Surface Luminance of } L_{\text{on5}}}{\text{Surface Luminance of } L_{\text{off5}}}$$

2. Surface luminance is luminance value at point 5 across the LCD surface 50cm from the surface with all pixels displaying white. From more information see FIG 2. LED current I_F = typical value (without driver board), LED input $V_{DDB} = 24V$, I_{DDB} = Typical value (with driver board), $L_{WH} = L_{on5}$ where L_{on5} is the luminance with all pixels displaying white at center 5 location.

3. The variation in surface luminance, δ_{WHITE} is defined (center of Screen) as:

$$\delta_{\text{WHITE(9P)}} = \frac{\text{Maximum}(L_{\text{on1}}, L_{\text{on2}}, \dots, L_{\text{on9}})}{\text{Minimum}(L_{\text{on1}}, L_{\text{on2}}, \dots, L_{\text{on9}})}$$

4. Response time T_Y is the average time required for display transition by switching the input signal for five luminance ratio (0%,25%,50%,75%,100% brightness matrix) and is based on $F_v = 60\text{Hz}$ to optimize.

Measured Response Time		Target				
		0%	25%	50%	75%	100%
Start	0%		0% to 25%	0% to 50%	0% to 75%	0% to 100%
	25%	25% to 0%		25% to 50%	25% to 75%	25% to 100%
	50%	50% to 0%	50% to 25%		50% to 75%	50% to 100%
	75%	75% to 0%	75% to 25%	75% to 50%		75% to 100%
	100%	100% to 0%	100% to 25%	100% to 50%	100% to 75%	

T_Y is determined by 10% to 90% brightness difference of rising or falling period. (As illustrated)

The response time is defined as the following figure and shall be measured by switching the input signal for “any level of gray(bright)” and “any level of gray(dark)”.

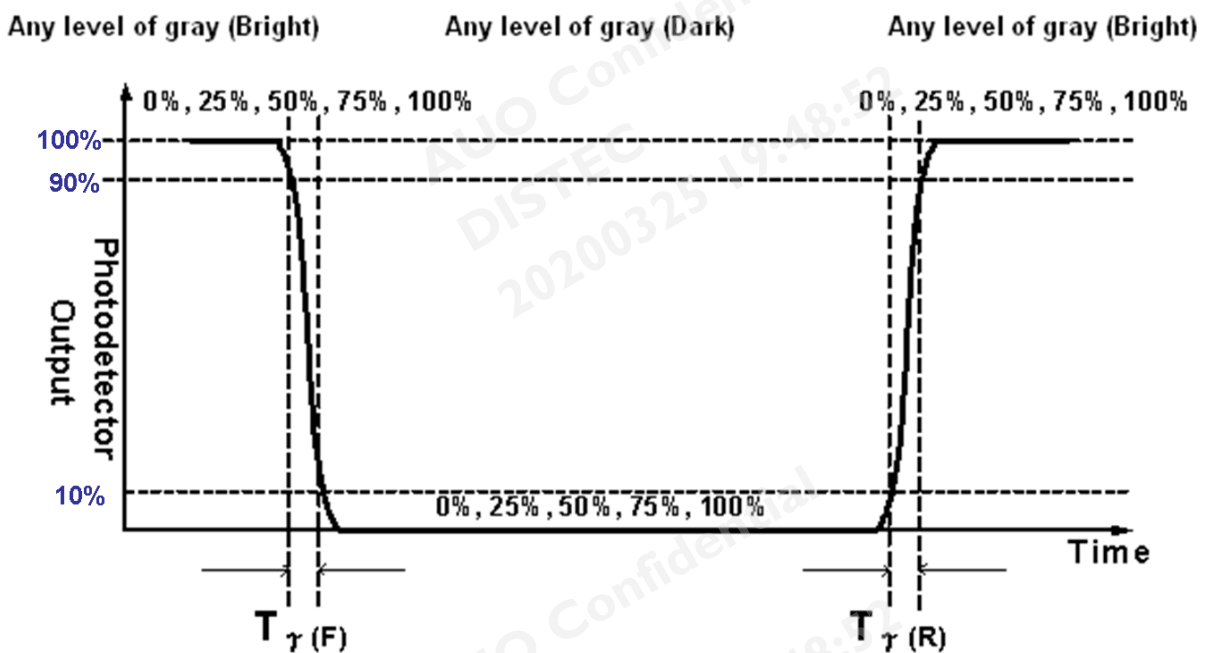
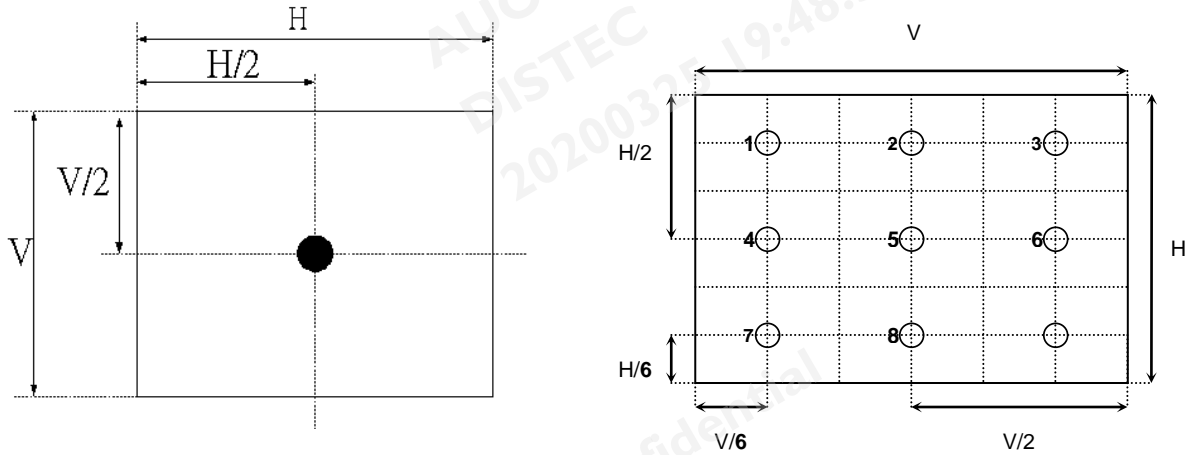
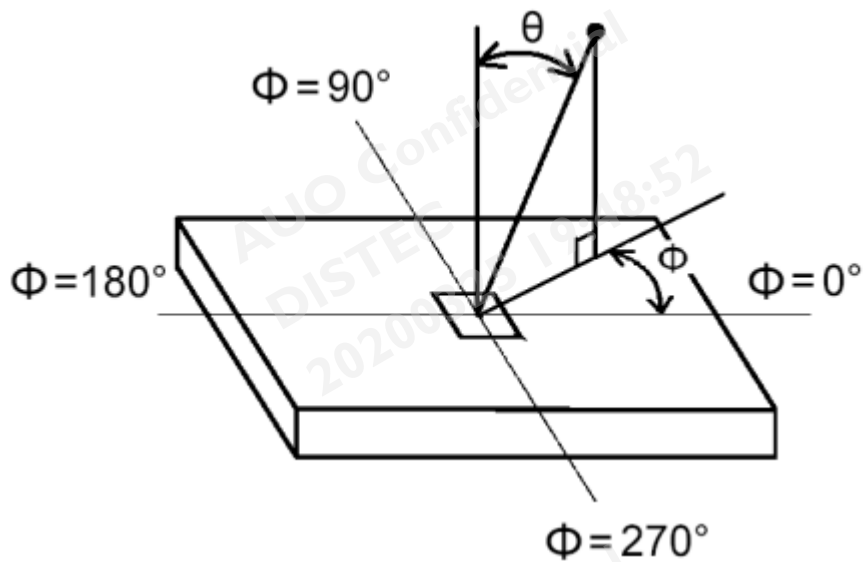

FIG. 2 Luminance



5. Viewing angle is the angle at which the contrast ratio is greater than 10. The angles are determined for the horizontal or x axis and the vertical or y axis with respect to the z axis which is normal to the LCD surface. For more information see FIG3.

FIG.3 Viewing Angle



1.3. Mechanical Characteristics

The contents provide general mechanical characteristics for the model P430QVN02.0 In addition the figures in the next page are detailed mechanical drawing of the LCD.

Item	Dimension	Unit	Note	
Outline Dimension	Horizontal	963.7	mm	
	Vertical	552.0	mm	
	Depth (Dmin)	17.4	mm	front bezel to back bezel
	Depth (Dmax)	26.9	mm	to DB cover
Weight	10640	G	w/ DB	

1.3.1. Placement Suggestions

1. Landscape Mode: The default placement is T-Con Side on the lower side and the image is shown upright via viewing from the front.
2. Portrait Mode: The default placement is that T-Con side has to be placed on the left side via viewing from the front.

Landscape (Front view)

Portrait (Front view)

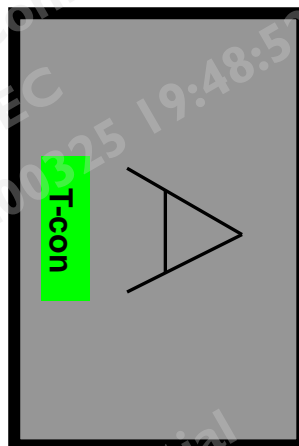
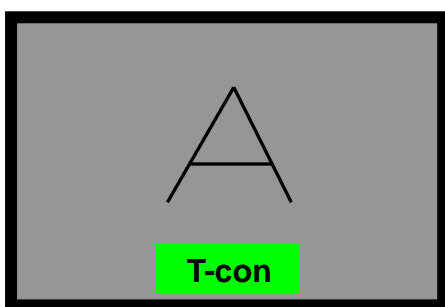

Front View

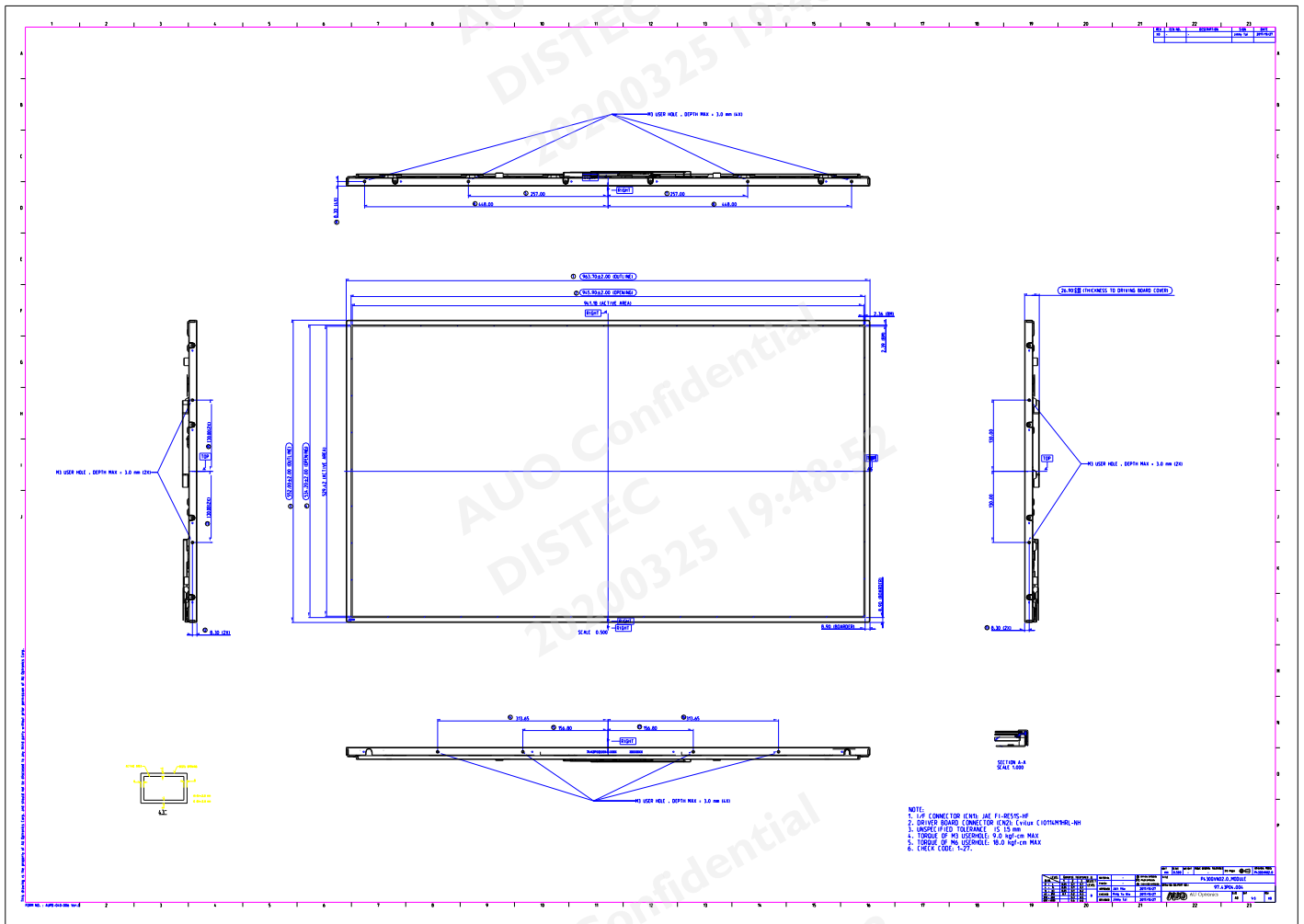

Back View 1

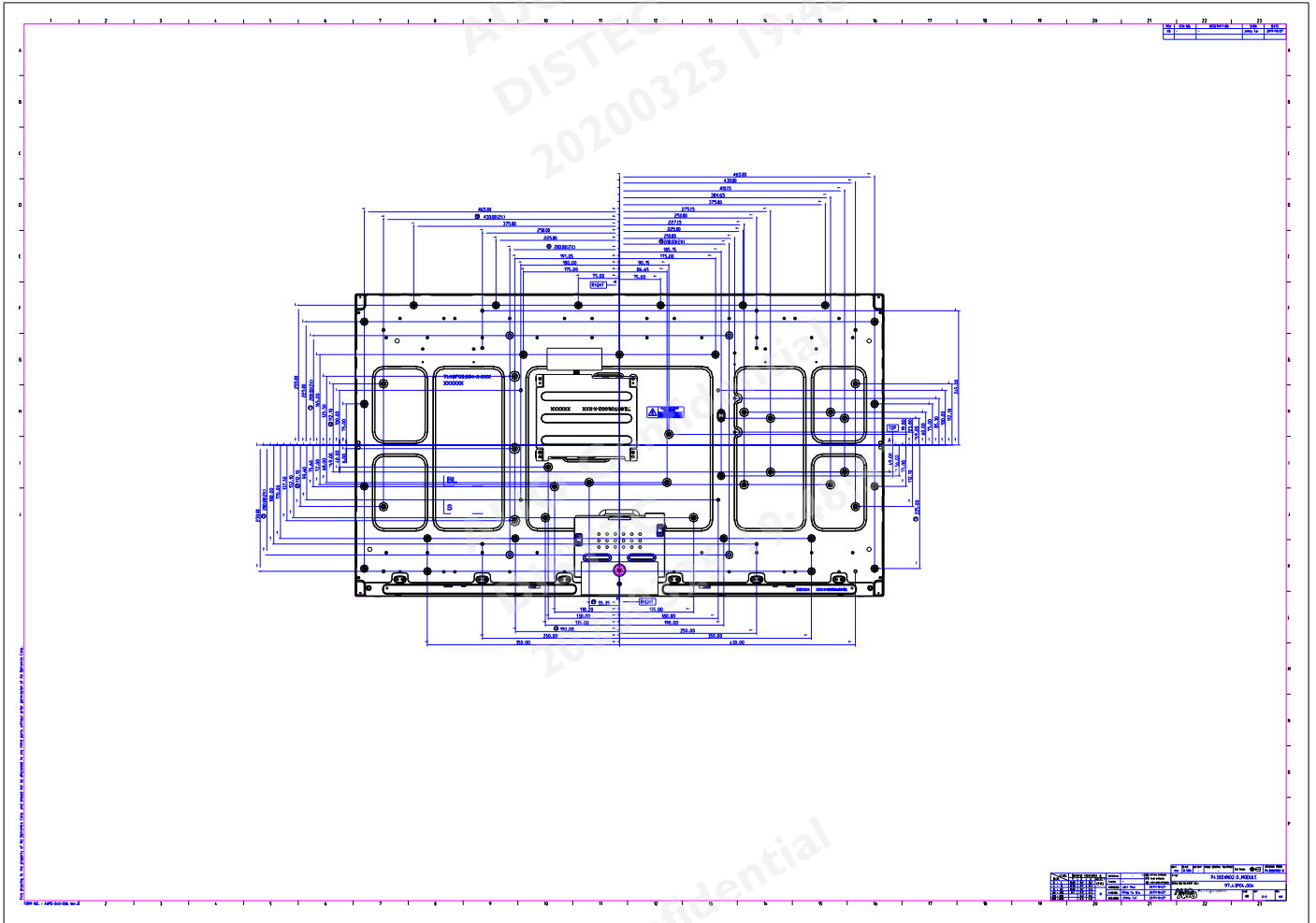

Back View 2

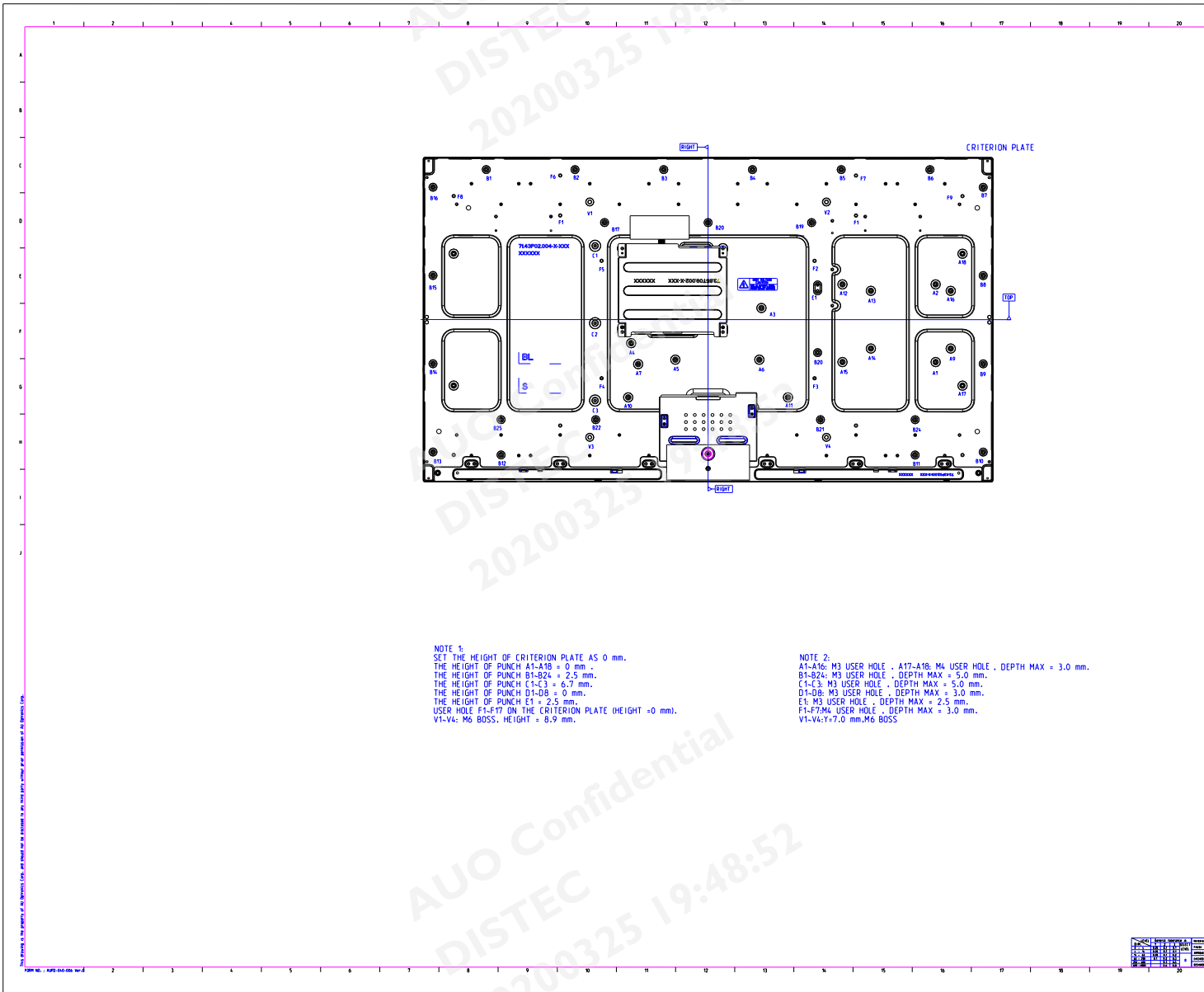

2. Absolute Maximum Ratings

The followings are maximum values which, if exceeded, may cause faulty operation or damage to the unit

Item	Symbol	Min	Max	Unit	Conditions
Logic/LCD Drive Voltage	Vcc	-0.3	14	[Volt]	Note 1
Input Voltage of Signal	Vin	-0.3	4	[Volt]	Note 1
Operating Temperature	TOP	0	+50	[°C]	Note 2
Operating Humidity	HOP	10	90	[%RH]	Note 2
Storage Temperature	TST	-20	+60	[°C]	Note 2
Storage Humidity	HST	10	90	[%RH]	Note 2
Panel Surface Temperature	PST		70	[°C]	Note 3

Note 1: Duration:50 msec.

Note 2 : Maximum Wet-Bulb should be 39°C and No condensation.

The relative humidity must not exceed 90% non-condensing at temperatures of 40°C or less. At temperatures greater than 40°C, the wet bulb temperature must not exceed 39°C.

Note 3: Surface temperature is measured at 50°C Dry condition

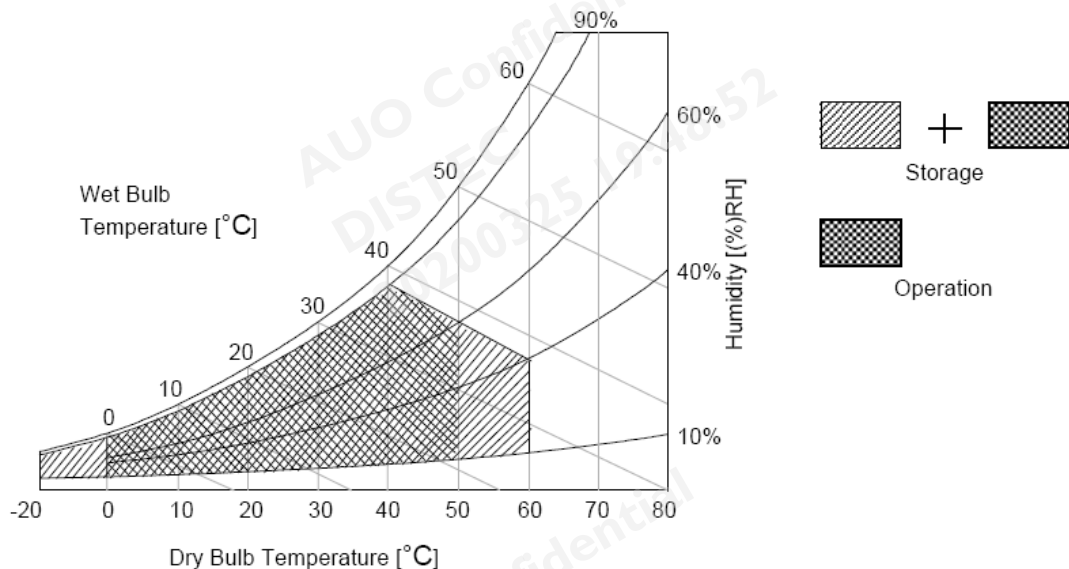

3. Electrical Specification

The P430QVN02.0 requires two power inputs. One is employed to power the LCD electronics and to drive the TFT array and liquid crystal. The other is to power Back Light Unit.

3.1. Electrical Characteristics

3.1.1. DC Characteristics (Ta = 25 ± 2 °C)

Item		Symbol	Min.	Typ.	Max	Unit	
LCD							
Power Supply Input Voltage		V _{DD}	10.8	12	13.2	V	1
Power Supply Input Current	Black pattern	I _{DD}	-	0.84	1.01	A	2
	White pattern		-	1.83	2.2	A	
	H-Strip pattern		-	1.54	1.85	A	
Power Consumption	Black pattern	P _C	-	10.08	12.12	Watt	
	White pattern		-	21.96	26.4	Watt	
	H-Strip pattern		-	18.45	22.2	Watt	
Inrush Current		I _{RUSH}	--	--	5	A	3
CMOS Interface	Input High Threshold Voltage	V _{IH} (High)	2.7	--	3.3	V _{DC}	4
	Input Low Threshold Voltage	V _{IL} (Low)	0	--	0.6	V _{DC}	4
V-by-one Interface	CML Differential Input High Threshold	VRTH	+50	--	--	mVDC	
	CML Differential Input Low Threshold	VRTL	--	--	-50	mVDC	
	CML Common mode Bias Voltage	VRCT	0.8	0.9	1.0	mVDC	

3.1.2. AC Characteristics ($T_a = 25 \pm 2 \text{ }^\circ\text{C}$)

Item		Symbol	Min.	Typ.	Max	Unit	Note
V-by-one Interface	VRXINP/N input each bit Period	T_{RRIP} (UI)	250	--	625	ps	10bit 1
	Receiver Clock : Spread Spectrum Modulation range	Fclk_ss	Fclk -0.5%	--	Fclk +0.5%	MHz	2
	Receiver Clock : Spread Spectrum Modulation frequency	Fss	--	--	30	KHz	2
	CDR training pattern time	T_{LOCK}	--	500	--	us	1
	Latency from LOCKN 'HIGH' to clock training pattern	L1	0	--	--	us	1
	Latency from LOCKN 'LOW' to normal 8b10b data	L2	--	--	70	us	1
	CML Differential Input High Threshold	V_{RTH}	+50	--	--	mV _{DC}	
	CML Differential Input Low Threshold	V_{RTL}	--	--	-50	mV _{DC}	
	CML Common mode Bias Voltage	V_{RCT}	-0.1	0	0.1	V _{DC}	
	Intra-pair skew	T_{INTRA}	--	--	0.3	UI	3
	Inter-pair skew	T_{INTER}	--	--	380	UI	4
	Eye diagram at receiver	A_X	--	0.25	--	UI	8
		A_Y	--	0	--	mV	
		B_X	--	0.3	--	UI	
		B_Y	--	50	--	mV	
C_X		--	0.7	--	UI		
C_Y		--	50	--	mV		
D_X		--	0.75	--	UI		
D_Y		--	0	--	mV		
E_X	--	0.7	--	UI			
E_Y	--	-50	--	mV			
F_X	--	0.3	--	UI			
F_Y	--	-50	--	mV			

3.1.3. Driver Characteristics

Item	Symbol	Min	Max	Unit	condition
Driver Surface Temperature	DST		100	[°C]	Note

Note : Any point on the driver surface must be less than 100°C under any conditions.

3.1.4. TCON Characteristics

Item	Symbol	Min	Max	Unit	condition
TCON Surface Temperature	TST		85	[°C]	Note

Note: Any point on the TCON surface must be less than 85°C under any conditions.

Note1. The ripple voltage should be fewer than 5% of VDD.

Note2. Test Condition:

- (1) $V_{DD} = 12.0V$, (2) $F_v = 60Hz$, (3) $F_{clk} = 74.25MHz$, (4) Temperature = 25 °C
- (5) Power dissipation check pattern. (Only for power design)

a. Black pattern



b. White pattern



c. H-Strip pattern

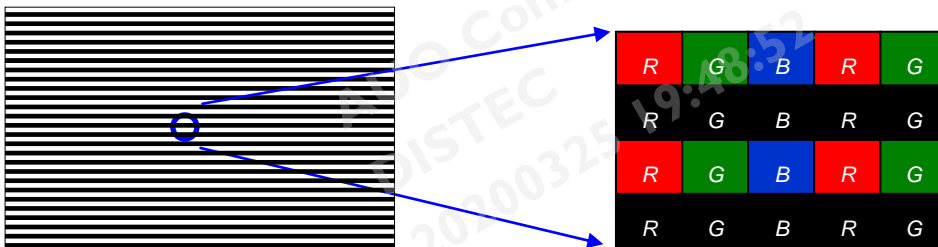

Note3. Measurement condition : Rising time = 400us

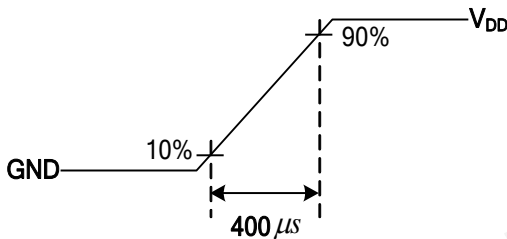

Note4. The measure points of V_{IH} and V_{IL} are in LCM side after connecting the System Board and LCM

Note5. V-by-one Receiver start up timing waveform

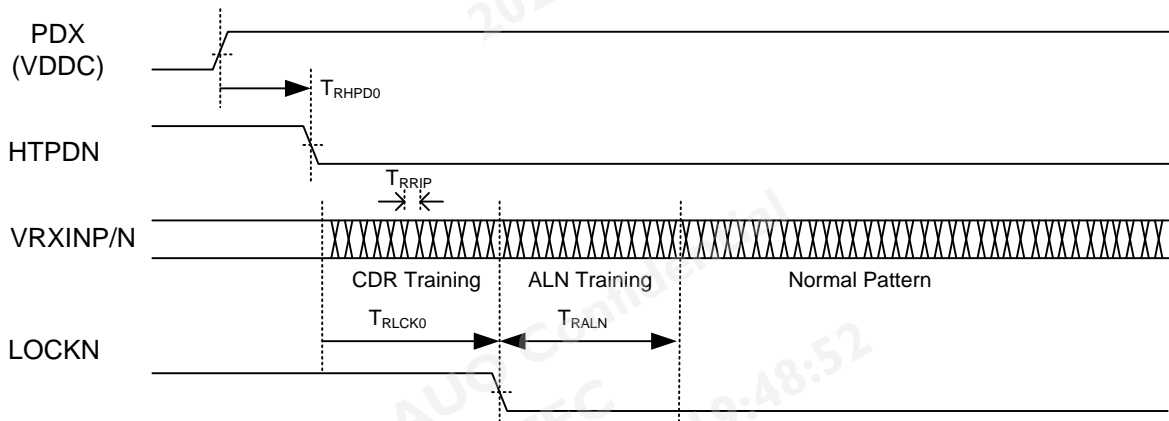

Note6. V-by-one Intra-pair Skew

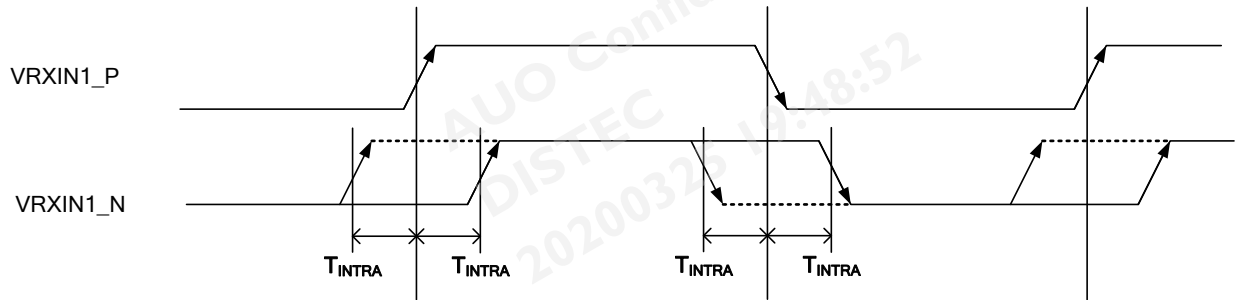

Note7. V-by-one Inter-pair Skew

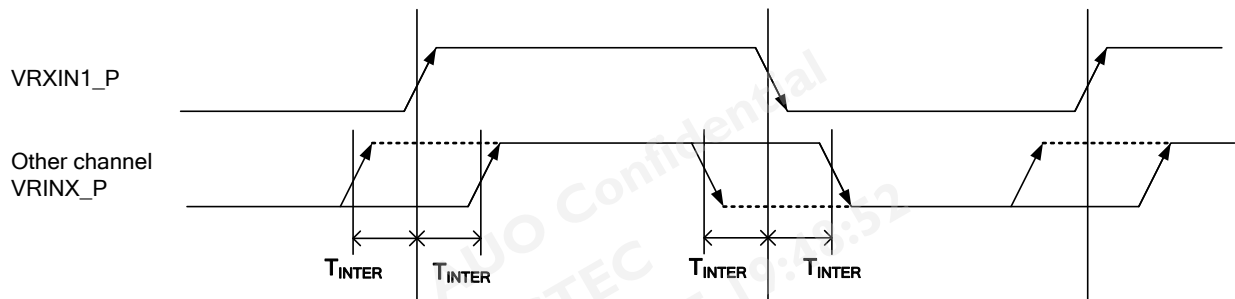

Note8. Eye diagram at receiver

Eye Mask

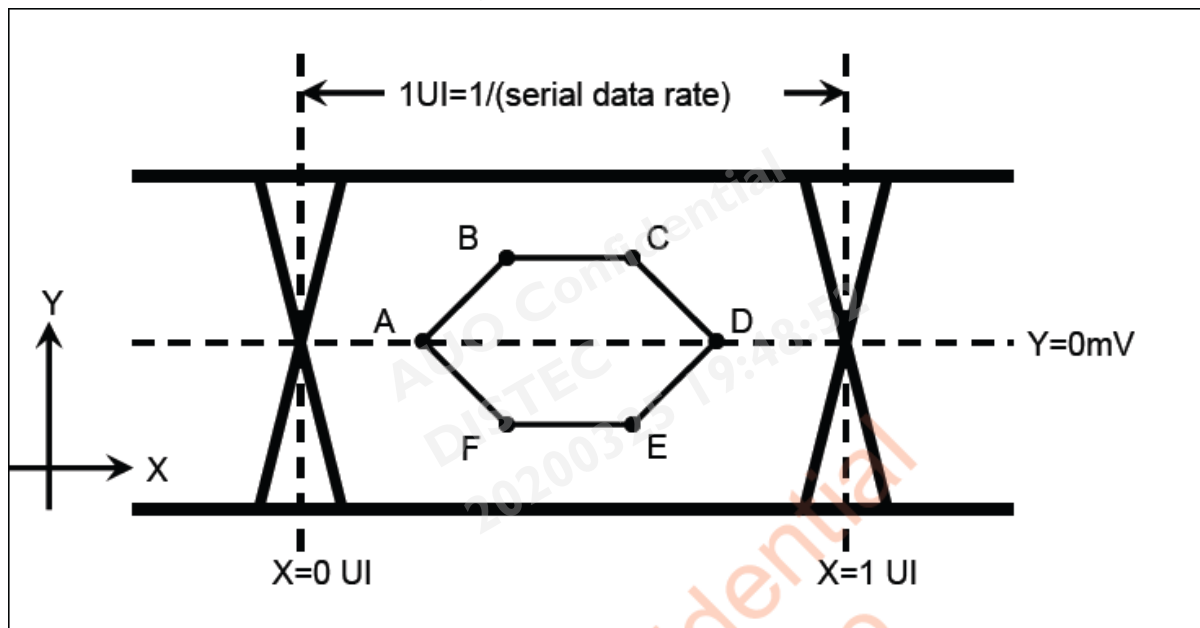

Example of Eye diagram



Note9. The relative humidity must not exceed 80% non-condensing at temperatures of 40°C or less. At temperatures greater than 40°C, the wet bulb temperature must not exceed 39°C.

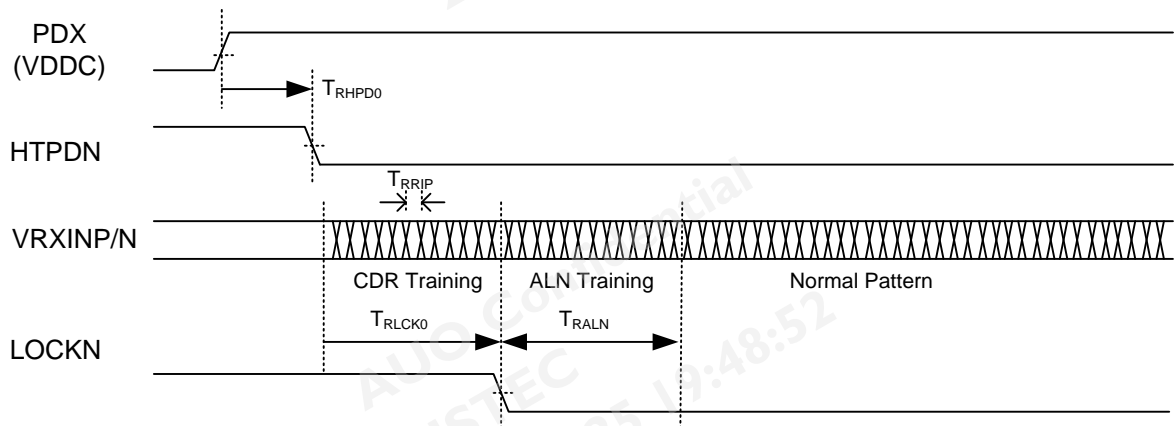

3.2. Interface Connections

LCD connector: JAE FI-RTE51SZ-HF (LVDS connector) or compatible

PIN	Symbol	Description
1	VIN	12V
2	VIN	12V
3	VIN	12V
4	VIN	12V
5	VIN	12V
6	VIN	12V
7	VIN	12V
8	VIN	12V
9	N.C.	No connection
10	GND	Ground
11	GND	Ground
12	GND	Ground
13	GND	Ground
14	GND	Ground
15	N.C.	No connection
16	N.C.	No connection
17	N.C.	No connection
18	N.C.	No connection
19	N.C.	No connection
20	N.C.	No connection
21	N.C.	No connection
22	N.C.	No connection
23	N.C.	No connection
24	GND	Ground
25	HTPDN	Vx1 HTPDN
26	LOCKN	Vx1 LOCK
27	GND	Ground
28	RX0N	Vx1 lane 0
29	RX0P	Vx1 lane 0
30	GND	Ground
31	RX1N	Vx1 lane 1
32	Rx1P	Vx1 lane 1
33	GND	Ground
34	RX2N	Vx1 lane 2

35	RX2P	Vx1 lane2
36	GND	Ground
37	RX3N	Vx1 lane 3
38	RX3P	Vx1 lane 3
39	GND	Ground
40	RX4N	Vx1 lane 4
41	RX4P	Vx1 lane 4
42	GND	Ground
43	RX5N	Vx1 lane 5
44	RX5P	Vx1 lane 5
45	GND	Ground
46	RX6N	Vx1 lane 6
47	RX6P	Vx1 lane 6
48	GND	Ground
49	RX7N	Vx1 lane 7
50	RX7P	Vx1 lane 7
51	GND	Ground

V by one color data mapping

Mode		Packer input & Unpacker output	30bpp RGB /YCbCr444 (10bit)	
4byte mode	3byte mode	Byte0	D[0]	R/Cr[2]
			D[1]	R/Cr[3]
			D[2]	R/Cr[4]
			D[3]	R/Cr[5]
			D[4]	R/Cr[6]
			D[5]	R/Cr[7]
			D[6]	R/Cr[8]
			D[7]	R/Cr[9]
		Byte1	D[8]	G/Y[2]
			D[9]	G/Y[3]
			D[10]	G/Y[4]
			D[11]	G/Y[5]
			D[12]	G/Y[6]
			D[13]	G/Y[7]
			D[14]	G/Y[8]
			D[15]	G/Y[9]
		Byte2	D[16]	B/Cb[2]
			D[17]	B/Cb[3]
			D[18]	B/Cb[4]
			D[19]	B/Cb[5]
			D[20]	B/Cb[6]
			D[21]	B/Cb[7]
			D[22]	B/Cb[8]
			D[23]	B/Cb[9]
	Byte3	D[24]	--	
		D[25]	--	
		D[26]	B/Cb[0]	
		D[27]	B/Cb[1]	
		D[28]	G/Y[0]	
		D[29]	G/Y[1]	
		D[30]	R/Cr[0]	
		D[31]	R/Cr[1]	

3.3. Signal Timing Specification

This is the signal timing required at the input of the user connector. All of the interface signal timing should be satisfied with the following specifications for its proper operation.

Timing Table (DE only Mode)

Signal	Item	Symbol	Min.	Typ.	Max	Unit
Vertical Section	Period	Tv	2200	2250	2715	Th
	Active	Tdisp (v)	2160			
	Blanking	Tblk (v)	40	90	555	Th
Horizontal Section	Period	Th	530	550	600	Tclk
	Active	Tdisp (h)	480			
	Blanking	Tblk (h)	50	70	120	Tclk
Clock	Frequency	Fclk=1/Tclk	66	74.25	77	MHz
Vertical Frequency	Frequency	Fv	47	60	63	Hz
Horizontal Frequency	Frequency	Fh	120	135	139.2	KHz

Notes:

(1) Display position is specific by the rise of DE signal only.

Horizontal display position is specified by the rising edge of 1st DCLK after the rise of 1st DE, is displayed on the left edge of the screen.

(2) Vertical display position is specified by the rise of DE after a "Low" level period equivalent to eight times of horizontal period. The 1st data corresponding to one horizontal line after the rise of 1st DE is displayed at the top line of screen.

(3) If a period of DE "High" is less than 3840 DCLK or less than 2160 lines, the rest of the screen displays black.

(4) The display position does not fit to the screen if a period of DE "High" and the effective data period do not synchronize with each other.

3.4. Color Input Data Reference

The brightness of each primary color (red, green, blue) is based on the 10 bit gray scale data input for the color; the higher the binary input, the brighter the color. The table below provides a reference for color versus data input.

COLOR DATA REFERENCE

Color		Input Color Data																													
		RED										GREEN										BLUE									
		MSB					LSB					MSB					LSB					MSB					LSB				
		R9	R8	R7	R6	R5	R4	R3	R2	R1	R0	G9	G8	G7	G6	G5	G4	G3	G2	G1	G0	B9	B8	B7	B6	B5	B4	B3	B2	B1	B0
Basic Color	Black	0	0	0	0	0	0	0	0	0	0	0	0	0	0	0	0	0	0	0	0	0	0	0	0	0	0	0	0	0	0
	Red(1023)	1	1	1	1	1	1	1	1	1	1	0	0	0	0	0	0	0	0	0	0	0	0	0	0	0	0	0	0	0	0
	Green(1023)	0	0	0	0	0	0	0	0	0	0	1	1	1	1	1	1	1	1	1	1	0	0	0	0	0	0	0	0	0	0
	Blue(1023)	0	0	0	0	0	0	0	0	0	0	0	0	0	0	0	0	0	0	0	0	1	1	1	1	1	1	1	1	1	1
	Cyan	0	0	0	0	0	0	0	0	0	0	1	1	1	1	1	1	1	1	1	1	1	1	1	1	1	1	1	1	1	1
	Magenta	1	1	1	1	1	1	1	1	1	1	0	0	0	0	0	0	0	0	0	0	1	1	1	1	1	1	1	1	1	1
	Yellow	1	1	1	1	1	1	1	1	1	1	1	1	1	1	1	1	1	1	1	1	0	0	0	0	0	0	0	0	0	0
	White	1	1	1	1	1	1	1	1	1	1	1	1	1	1	1	1	1	1	1	1	1	1	1	1	1	1	1	1	1	1
R	RED(000)	0	0	0	0	0	0	0	0	0	0	0	0	0	0	0	0	0	0	0	0	0	0	0	0	0	0	0	0	0	
	RED(001)	0	0	0	0	0	0	0	0	1	0	0	0	0	0	0	0	0	0	0	0	0	0	0	0	0	0	0	0	0	

	RED(1022)	1	1	1	1	1	1	1	1	1	0	0	0	0	0	0	0	0	0	0	0	0	0	0	0	0	0	0	0	0	
	RED(1023)	1	1	1	1	1	1	1	1	1	0	0	0	0	0	0	0	0	0	0	0	0	0	0	0	0	0	0	0	0	
G	GREEN(000)	0	0	0	0	0	0	0	0	0	0	0	0	0	0	0	0	0	0	0	0	0	0	0	0	0	0	0	0	0	
	GREEN(001)	0	0	0	0	0	0	0	0	0	0	0	0	0	0	0	0	0	0	1	0	0	0	0	0	0	0	0	0	0	

	GREEN(1022)	0	0	0	0	0	0	0	0	0	1	1	1	1	1	1	1	1	1	0	0	0	0	0	0	0	0	0	0	0	
	GREEN(1023)	0	0	0	0	0	0	0	0	0	1	1	1	1	1	1	1	1	1	1	0	0	0	0	0	0	0	0	0	0	
B	BLUE(000)	0	0	0	0	0	0	0	0	0	0	0	0	0	0	0	0	0	0	0	0	0	0	0	0	0	0	0	0	0	
	BLUE(001)	0	0	0	0	0	0	0	0	0	0	0	0	0	0	0	0	0	0	0	0	0	0	0	0	0	0	0	0	1	

	BLUE(1022)	0	0	0	0	0	0	0	0	0	0	0	0	0	0	0	0	0	0	0	1	1	1	1	1	1	1	1	1	0	
	BLUE(1023)	0	0	0	0	0	0	0	0	0	0	0	0	0	0	0	0	0	0	0	1	1	1	1	1	1	1	1	1	1	

3.5. Power Sequence for LCD

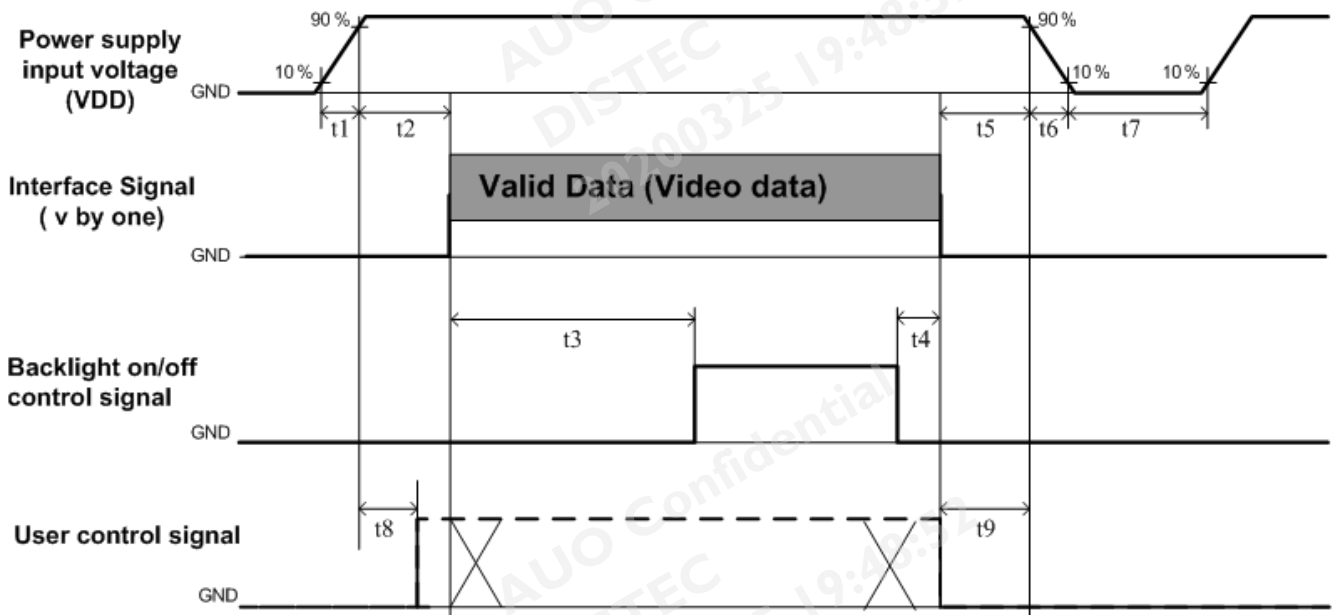

Parameter	Values			Unit
	Min.	Type.	Max.	
t1	0.4	---	30	ms
t2	40	---	---	ms
t3	640	---	---	ms
t4	0 ^{*1}	---	---	ms
t5	0	---	---	ms
t6	---	---	--- ^{*2}	ms
t7	1000	---	---	ms
t8	20 ^{*3}	---	50	ms
t9	0	---	---	ms

Note:

- (1) $t_4=0$: concern for residual pattern before BLU turn off.
- (2) t_6 : voltage of VDD must decay smoothly after power-off. (customer system decide this value)
- (3) When user control signal is N.C. (no connection), opened in Transmitted end, t_8 timing spec can be negligible.

3.6. Backlight Specification

3.6.1. Electrical specification ($T_a = 25 \pm 2 \text{ }^\circ\text{C}$)

	Item	Symbol		Condition	Spec			Unit	Note
					Min	Typ	Max		
1	Input Voltage	V _{DDB}		-	22.8	24	25.2	VDC	-
2	Input Current	I _{DDB}		V _{DDB} =24V		5.43	5.86	ADC	1
3	Input Power	P _{DDB}		V _{DDB} =24V		130.2	140.6	W	1
4	Inrush Current	I _{RUSH}		V _{DDB} =24V		-	8.3	ADC	2
5	On/Off control voltage	V _{B_{LON}}	ON	2 0	3.3	5.5	5.5	VDC	-
			OFF		0.8	0.8	0.8		-
6	On/Off control current	I _{B_{LON}}		V _{DDB} =24V	-	-	1.5	mA	-
7	External PWM Control Voltage	V _{EPWM}	MAX	2	-	5.5	5.5	VDC	-
			MIN	0	-	0.8	0.8		-
8	External PWM Control Current	I _{EPWM}		V _{DDB} =24V	-	-	2	mADC	-
9	External PWM Duty ratio	D _{EPWM}		V _{DDB} =24V	5	-	100	%	3
10	External PWM Frequency	F _{EPWM}		V _{DDB} =24V	120	180	960	Hz	-
11	DET status signal	DET	HI	Open Collector	Open Collector			VDC	4
			Lo		0.8	0.8	0.8	VDC	4
12	Input Impedance	R _{in}		V _{DDB} =24V	300			Kohm	-

Note 1 : Dimming ratio= 100% (MAX) ($T_a=25\pm 5^\circ\text{C}$, Turn on for 45minutes)

Note 2: Measurement condition Rising time = 20ms (V_{DDB} : 10%~90%);

Note 3: Less than 5% dimming control is functional well and no backlight shutdown happened

Note 4: Normal: 0~0.8V; Abnormal: Open collector

3.6.2. Input Pin Assignment

LED driver board connector : Cvilux CI0114M1HR0-NH or compatible

Pin	Symbol	Description
1	VDDB	Operating Voltage Supply, +24V DC regulated
2	VDDB	Operating Voltage Supply, +24V DC regulated
3	VDDB	Operating Voltage Supply, +24V DC regulated
4	VDDB	Operating Voltage Supply, +24V DC regulated
5	VDDB	Operating Voltage Supply, +24V DC regulated
6	BLGND	Ground and Current Return
7	BLGND	Ground and Current Return
8	BLGND	Ground and Current Return
9	BLGND	Ground and Current Return
10	BLGND	Ground and Current Return
11	DET	BLU status detection: Normal : 0~0.8V ; Abnormal : Open collector (Recommend Pull high R > 10K, VDD = 3.3V)
12	VBLON	BLU On-Off control: High/Open (2~5.5V) : BL On ; Low (0~0.8V/GND) : BL Off
13	NC	NC
14	PDIM(*)	External PWM (5%~100% Duty, open for 100%)



PWM Dimming : include Internal and External PWM Dimming

(Note*) IF External PWM function includes 5% dimming ratio. Judge condition as below:

- (1) Backlight module must be lighted ON normally.
- (2) All protection function must work normally.

Uniformity and flicker could NOT be guaranteed

3.6.3. Power Sequence for Backlight

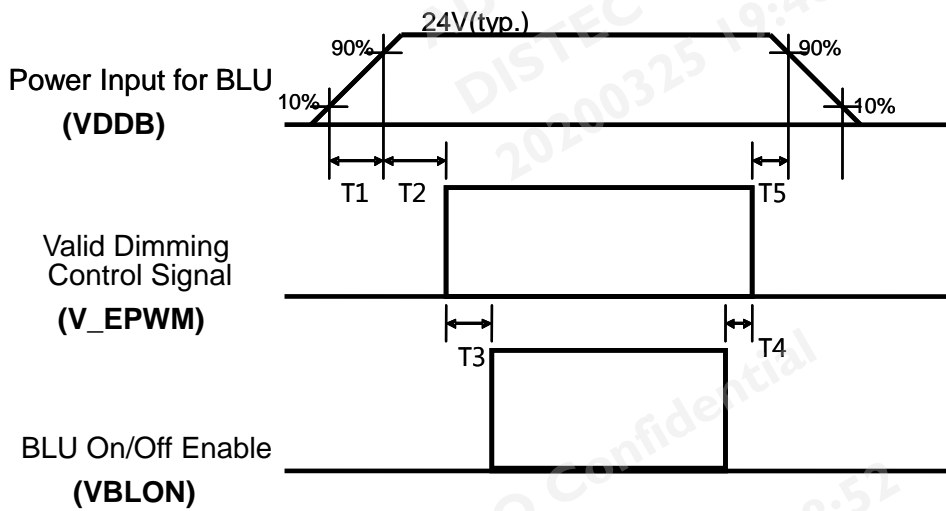

Dip condition

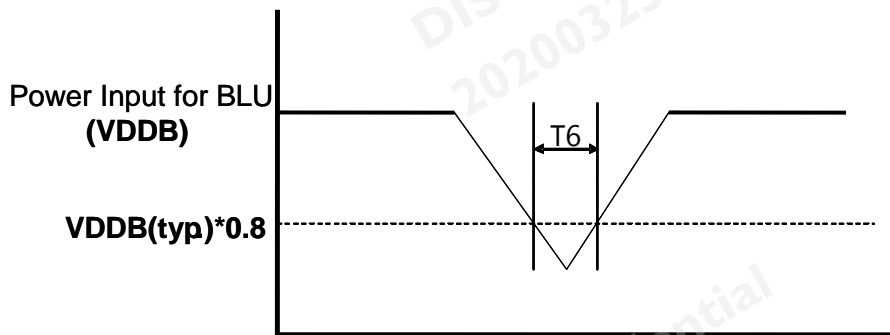

Parameter	Value			Units
	Min	Typ	Max	
T1	20	-	-	ms
T2	250	-	-	ms
T3	200	-	-	ms
T4	0	-	-	ms
T5	0	-	-	ms
T6	-	-	1000	ms ^{*1}

Note:1. T6 describes VDDB dip condition and VDDB couldn't lower than 10% VDDB.

3.6.4. LED Operating Life Time

Parameter	Symbol	Value			Unit	Note
		Min.	Typ.	Max		
Backlight Operating Life Time(MTTF)		70000			Hour	1

Note:

- The lifetime (MTTF) is defined as the time which luminance of LED is 50% compared to its original value.
[Operating condition: Continuous operating at Ta = 25±2°C, for single lamp/LED only]

4. Reliability Test Items

	Test Item	Q'ty	Condition
1	High temperature storage test	3	60°C, 500hrs
2	Low temperature storage test	3	-20°C, 500hrs
3	High temperature operation test	3	50°C, 500hrs
4	Low temperature operation test	3	-5°C, 500hrs
5	Vibration test (non-operation)	3	Wave form: random Vibration level : 1.0G RMS Bandwidth : 10-300Hz Duration : X axis, Vertical, 10min Y axis, Vertical, 10min Z axis, Vertical, 10min one time each direction
6	Shock test (non-operation)	3	Shock level 50G ,11ms ±X,Y,Z axis Waveform: half sine wave Direction: One time each direction
7	Vibration test (With carton)	1CTN/10PCS	Random wave (1.04Grms 2~200Hz) Duration : X,Y,Z 20min per axes
8	Drop test (With carton)	1CTN/10PCS	Height: 254 cm Front>Back>Left>Right>Top>Bottom / 2 nd time

5. International Standard

5.1. Safety

- (1) UL 60950-1; Standard for Safety of Information Technology Equipment Including electrical Business Equipment.
- (2) IEC 60950-1; Standard for Safety of International Electrotechnical Commission
- (3) EN 60950-1; European Committee for Electrotechnical Standardization (CENELEC), EUROPEAN STANDARD for Safety of Information Technology Equipment Including Electrical Business Equipment.

5.2. EMC

- (1) ANSI C63.4 “Methods of Measurement of Radio-Noise Emissions from Low-Voltage Electrical and Electrical Equipment in the Range of 9kHz to 40GHz.” American National standards Institute(ANSI), 1992
- (2) C.I.S.P.R “Limits and Methods of Measurement of Radio Interface Characteristics of Information Technology Equipment.” International Special committee on Radio Interference.
- (3) EN 55022 “Limits and Methods of Measurement of Radio Interface Characteristics of Information Technology Equipment.” European Committee for Electrotechnical Standardization. (CENELEC), 1998

6. Packing

6.1. Definition of Label

A. Panel Label:



XXXXXXXXXXXX-XXXXXX

Panel Unique ID

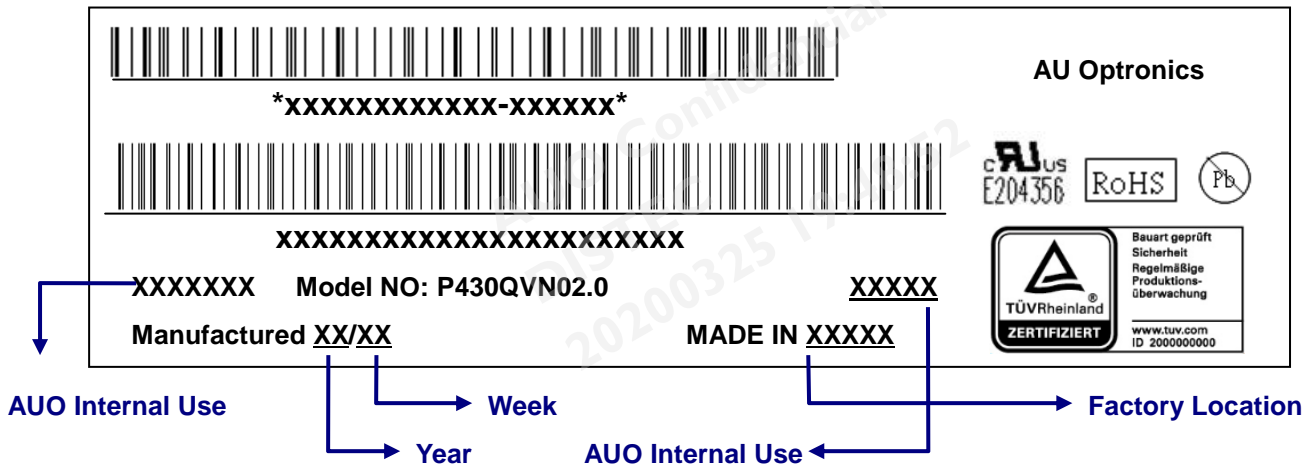
AUO Internal Use



Green mark description

- (1) For Pb Free Product, AUO will add  for identification.
- (2) For RoHS compatible products, AUO will add  for identification.

Note: The green Mark will be present only when the green documents have been ready by AUO internal green team. (definition of green design follows the AUO green design checklist.)

B. Carton Label:

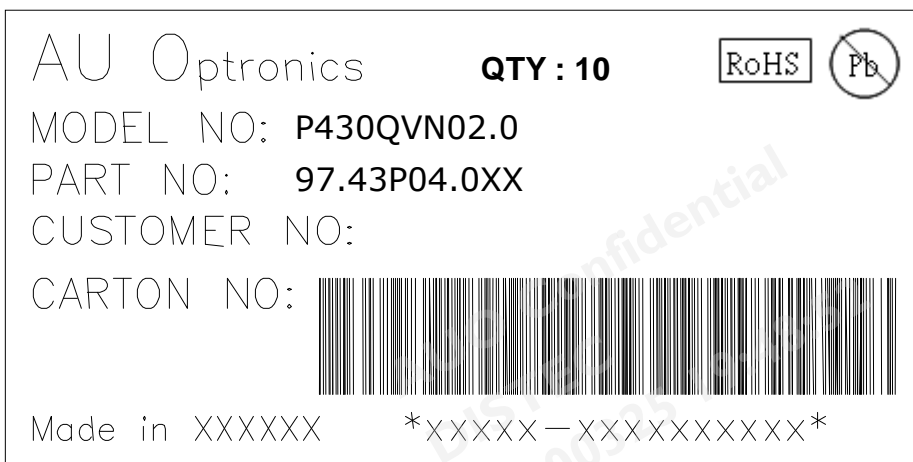

6.2. Packing Methods

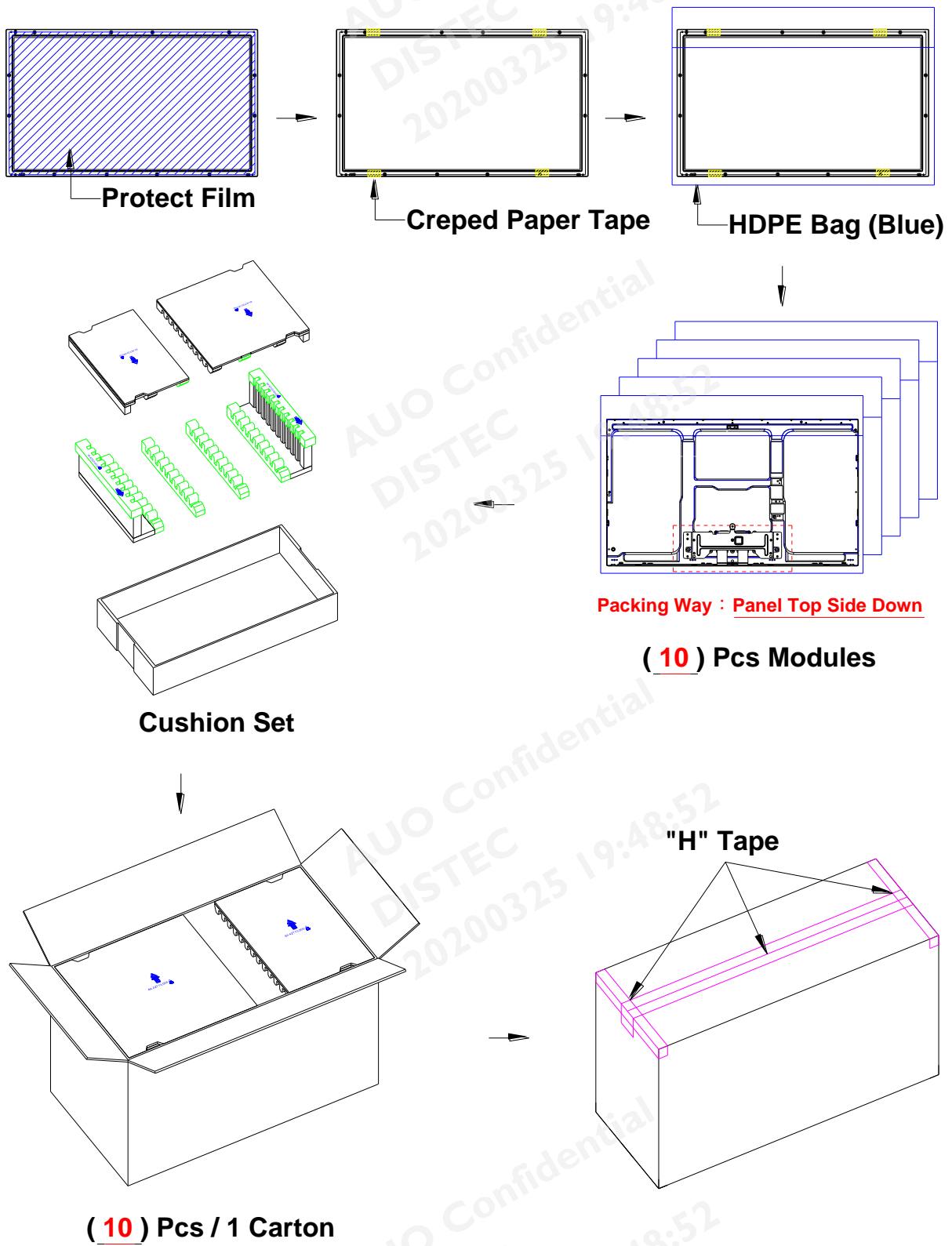

6.3. Pallet and Shipment Information

	Item	Specification			Packing Remark
		Qty.	Dimension	Weight (kg)	
1	Packing Box	10 pcs/box	1060(L)*560(W)*635(H)	109.7	Packing:4660g
2	Pallet	1	1150(L)*1070(W)*132(H)	15.6	
3	Boxes per Pallet	2 boxes/pallet			
4	Panels per Pallet	20 pcs/pallet			
5	Pallet after packing	20	1150(L)*1070(W)*1402(H)	235	

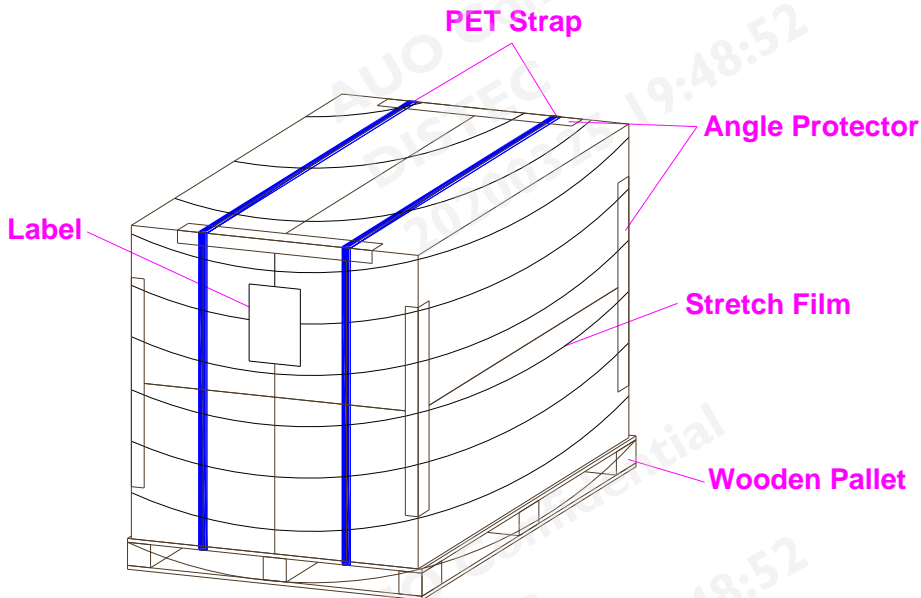

單棧 pallet 打棧示意圖

Single pallet packaging illustration

7. Precautions

Please pay attention to the followings when you use this TFT LCD module.

7.1. Mounting Precautions

- (1) You must mount a module using holes arranged in four corners or four sides.
- (2) You should consider the mounting structure so that uneven force (ex. twisted stress) is not applied to module. And the case on which a module is mounted should have sufficient strength so that external force is not transmitted directly to the module.
- (3) Please attach the surface transparent protective plate to the surface in order to protect the polarizer. Transparent protective plate should have sufficient strength in order to resist external force.
- (4) You should adopt radiation structure to satisfy the temperature specification.
- (5) Acetic acid type and chlorine type materials for the cover case are not desirable because the former generates corrosive gas of attacking the polarizer at high temperature and the latter cause circuit broken by electro-chemical reaction.
- (6) Do not touch, push or rub the exposed polarizer with glass, tweezers or anything harder than HB pencil lead. And please do not rub with dust clothes with chemical treatment. Do not touch the surface of polarizer for bare hand or greasy cloth. (Some cosmetics are detrimental to the polarizer.)
- (7) When the surface becomes dusty, please wipe gently with absorbent cotton or other soft materials like chamois soaks with petroleum benzene. Normal-hexane is recommended for cleaning the adhesives used to attach front/ rear polarizer. Do not use acetone, toluene and alcohol because they cause chemical damage to the polarizer.
- (8) Wipe off saliva or water drops as soon as possible. Their long time contact with polarizer causes deformations and color fading.
- (9) Do not open the case because inside circuits do not have sufficient strength.

7.2. Operating Precautions

- (1) The spike noise causes the mis-operation of circuits. It should be lower than following voltage:
 $V = \pm 200\text{mV}$ (Over and under shoot voltage)
- (2) Response time depends on the temperature. (In lower temperature, it becomes longer..)
- (3) Brightness depends on the temperature. (In lower temperature, it may become lower.) And in lower temperature, response time (required time that brightness is stable after turned on) becomes longer.
- (4) Be careful for condensation at sudden temperature change. Condensation makes damage to polarizer or electrical contacted parts. And after fading condensation, smear or spot will occur.
- (5) When fixed patterns are displayed for a long time, remnant image is likely to occur.
- (6) Module has high frequency circuits. Sufficient suppression to the electromagnetic interference shall be done by system manufacturers. Grounding and shielding methods may

be important to minimize the interface.

7.3. Operating Condition for Public Information Display

The device listed in the product specification is designed and manufactured for PID (Public Information Display) application. To optimize module's lifetime and function, below operating usages are required.

(1) Normal operating condition

- A. Operating temperature: 0~50°C
- B. Operating humidity: 10~90%
- C. Display pattern: dynamic pattern (Real display).

Note) Long-term static display would cause image sticking.

(2) Operation usage to protect against image sticking due to long-term static display.

- A. Suitable operating time: 24 hours a day or less.
(* The moving picture can be allowed for 24 hours a day)
- B. Liquid Crystal refresh time is required. Cycling display between 5 minutes' information (static) display and 10 seconds' moving image.
- C. Periodically change background and character (image) color.
- D. Avoid combination of background and character with large different luminance.

(3) Periodically adopt one of the following actions after long time display.

- A. Running the screen saver (motion picture or black pattern)
- B. Power off the system for a while

(4) LCD system is required to place in well-ventilated environment. Adapting active cooling system is highly recommended.

(5) Product reliability and functions are only guaranteed when the product is used under right operation usages. If product will be used in extreme conditions, such as high temperature/humidity, display stationary patterns, or long operation time etc..., it is strongly recommended to contact AUO for filed application engineering advice. Otherwise, its reliability and function may not be guaranteed. Extreme conditions are commonly found at airports, transit stations, banks, stock market and controlling systems.

7.4. Electrostatic Discharge Control

Since a module is composed of electronic circuits, it is not strong to electrostatic discharge. Make certain that treatment persons are connected to ground through wristband etc. And don't touch interface pin directly.

7.5. Precautions for Strong Light Exposure

(1) Strong light exposure causes degradation of polarizer and color filter.

(2) To keep display functional well as a digital signage application, especially the component of TFT is very sensitive with sunlight, it is necessary to set up blocking device protecting panel from radiation of ambient environment.

7.6. Storage

When storing modules as spares for a long time, the following precautions are necessary.

- (1) Store them in a dark place. Do not expose the module to sunlight or fluorescent light. Keep the temperature between 5°C and 35°C at normal humidity.
- (2) The polarizer surface should not come in contact with any other object. It is recommended that they be stored in the container in which they were shipped.
- (3) Storage condition is guaranteed under packing conditions.
- (4) The phase transition of Liquid Crystal in the condition of the low or high storage temperature will be recovered when the LCD module returns to the normal condition.

7.7. Handling Precautions for Protection Film

- (1) The protection film is attached to the bezel with a small masking tape. When the protection film is peeled off, static electricity is generated between the film and polarizer. This should be peeled off slowly and carefully by people who are electrically grounded and with well ion-blown equipment or in such a condition, etc.
- (2) When the module with protection film attached is stored for a long time, sometimes there remains a very small amount of glue still on the bezel after the protection film is peeled off.
- (3) You can remove the glue easily. When the glue remains on the bezel or its vestige is recognized, please wipe them off with absorbent cotton waste or other soft material like chamois soaked with normal-hexane.

Our company network supports you worldwide with offices in Germany, Austria, Switzerland, the UK and the USA. For more information please contact:

Headquarters

Germany



FORTEC Elektronik AG

Augsburger Str. 2b
82110 Germering

Phone: +49 89 894450-0
E-Mail: info@fortecag.de
Internet: www.fortecag.de

Fortec Group Members

Austria



Distec GmbH Office Vienna

Nuschinggasse 12
1230 Wien

Phone: +43 1 8673492-0
E-Mail: info@distec.de
Internet: www.distec.de

Germany



Distec GmbH

Augsburger Str. 2b
82110 Germering

Phone: +49 89 894363-0
E-Mail: info@distec.de
Internet: www.distec.de

Switzerland



ALTRAC AG

Bahnhofstraße 3
5436 Würenlos

Phone: +41 44 7446111
E-Mail: info@altrac.ch
Internet: www.altrac.ch

United Kingdom



Display Technology Ltd.

Osprey House, 1 Osprey Court
Hichingbrooke Business Park
Huntingdon, Cambridgeshire, PE29 6FN

Phone: +44 1480 411600
E-Mail: info@displaytechnology.co.uk
Internet: www.displaytechnology.co.uk

USA



Apollo Display Technologies, Corp.

87 Raynor Avenue,
Unit 1 Ronkonkoma,
NY 11779

Phone: +1 631 5804360
E-Mail: info@apolloDisplays.com
Internet: www.apolloDisplays.com