

Datasheet

PrismaMEDIA-II PR-01-272

**All-In-One RGB/Video/HDMI/DP Converter Board
for VGA – WUXGA Panels**

Rev 1.3.14

28.04.2016

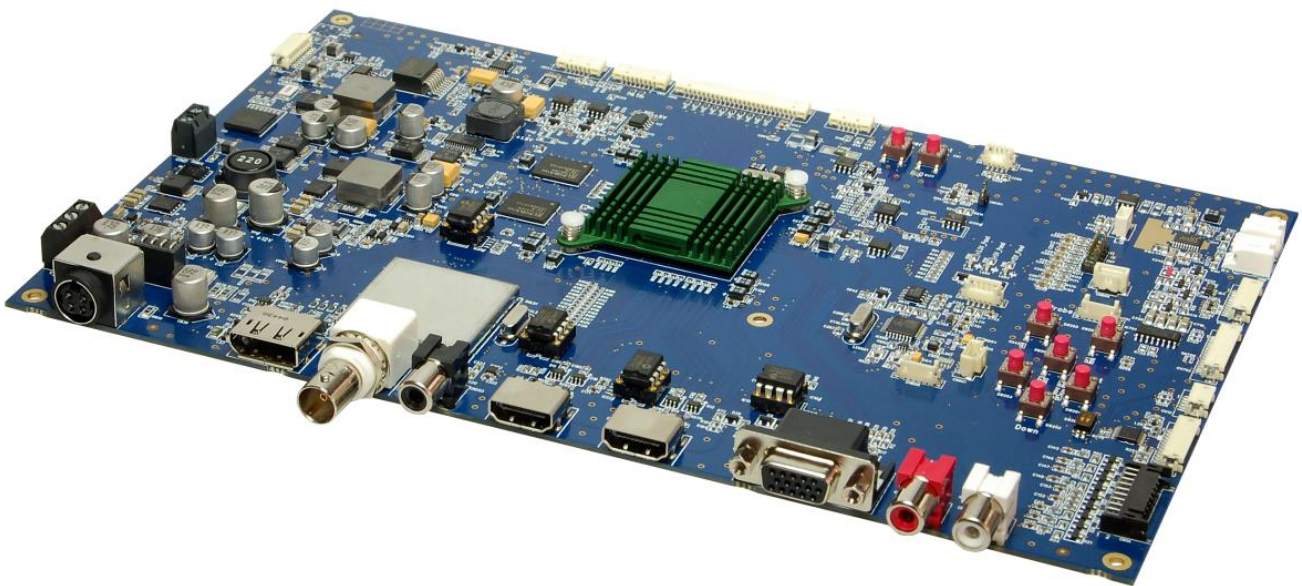

The information contained in this document has been carefully researched and is, to the best of our knowledge, accurate. However, we assume no liability for any product failures or damages, immediate or consequential, resulting from the use of the information provided herein. Our products are not intended for use in systems in which failures of product could result in personal injury. All trademarks mentioned herein are property of their respective owners. All specifications are subject to change without notice.



Table of Contents

1. Revision History	4
2. Overview	5
3. General Features	5
4. Hardware Features	5
5. Input / Output Interfaces.....	7
6. OSD Menu and User Controls	8
6.1 On-Board OSD Control	8
6.2 OSD Control Through External Keypad	10
6.3 OSD Control through IR Remote Control.....	11
7. On-Screen-Menu (OSM)	14
7.1 Sub-Menu "Image Settings"	14
7.2 Sub-Menu "Display Settings"	18
7.3 Sub-Menu "Audio Settings"	21
7.4 Sub-Menu "Position Settings"	23
7.5 Sub-Menu "OSD Settings".....	26
7.6 Sub-Menu "Setup"	27
8. Supported Input Modes	28
8.1 S-Video – CVBS.....	28
8.2 Component.....	28
8.3 VGA.....	28
8.4 HDMI – Graphics	29
8.5 HDMI – Video.....	29
8.6 SDI (Option).....	29
8.7 DP.....	29
9. Audio Support	30
9.1 Audio Input.....	30
9.2 Audio Output	30
9.3 Extended Audio Input Assignment	30
10. Absolute Maximum Ratings	31
11. Electrical Characteristics	32



12. Input Connectors	33
13. Output Connectors.....	37
14. I/O Connector	39
15. Connector Overview	40
16. Appendix A: Drawings	41
17. Appendix B: PSU	46



1. Revision History

Date	Rev.No.	Description	Page
July 7, 2009	1.0	Release of preliminary data sheet	
October 27, 2009	1.1	Board photo added	1
		Updated input/output interface drawing	5
		Changed external keypad photo	8
		Updated CN7 pinning	12
		CN800/CN800# default/optional reversed	14
April 1, 2010	1.2	Keypad picture changed, dimensions added	8
May 21, 2010	1.2.1	Name of IR connector corrected	9
June 03, 2010	1.2.2	On-Screen-Menu is added	10
June 15, 2010	1.2.3	General Features updated	3
		Hardware Features updated	4
		Electrical characteristics updated	20
		Added RS232 signal levels	25
		LVDS connectors updated	26
June 18, 2010	1.2.4	General overhaul	
June 29, 2010	1.2.5	OSD Control through IR Remote Control updated	10
July 05, 2010	1.2.6	Remote control picture updated	10
July 09, 2010	1.2.7	Correction on On-Board OSD picture	8
July 19, 2010	1.2.8	Ordering info section removed	6
		Information added about 12V/24V versions and labels	27
September 21, 2010	1.2.9	Audio Input changed	6
		Input/Output Connectors figure updated	7
		Audio Support added	27
October 11, 2010	1.2.10	Sub-Menu "Audio Settings" updated	20
		New OSD pictures updated	20, 21
		CN800# drawing updated	37
Nov 24, 2010	1.2.11	Input/Output Connectors figure updated	7
January 20, 2011	1.3.1	Cover picture updated	1
		Updated audio settings menu	20, 21
May 13, 2011	1.3.2	1920 x 1080 @24 added to SDI and HDMI video support list	27
June 23, 2011	1.3.3	Aspect ratio updated	18
July 11, 2011	1.3.4	Updated tiling limitations	19
July 14, 2011	1.3.5	CN800, CN800# connections modified	35
August 9, 2011	1.3.6	Video mode removed from VGA input	14,15
Sept 27, 2011	1.3.7	Button functions while OSD closed updated	8
Oct 20, 2011	1.3.8	Company contact info updated	44
Dec 20, 2011	1.3.9	CN17 pinning corrected	35
September 04, 2012	1.3.10	ADC calibration added to OSD	15
		Input search toggle added to OSD	26
		Added appendix for PSU low power control timings	44
September 06, 2013	1.3.11	Changed IR-Remote Table and format of the whole document	all
February 17, 2014	1.3.12	Reflect new standard assembly configuration (no SDI, no Audio Amp, no ARCB, no S/P-DIF)	1
Sept 2, 2014	1.3.13	Added PIP Matrix	19
April 28, 2016	1.3.14	Added "Port Change" dialog, Added HDMI 1.4 support	5, 13



2. Overview

The PrismaMEDIA-II is a powerful graphics processing board, providing high-quality images for TFT panels. This converter supports 6/8/10-bit LVDS panels up to WUXGA (1920 x 1200) and can be used in a variety of systems.

3. General Features

- Zoom and shrink scaling
- Frame rate conversion
- Faroudja Truelife video enhancer
- Faroudja RealColor color enhancing
- Supports VESA DDC2B and a subset of VESA DPMS standards
- PWM or voltage controlled backlight intensity
- Wide-range input voltage (up to 24V - optional, available on request)
- Six-button OSD - keypad interface and on-screen menus allow adjustments to the system
- True High Definition 1080p on 2xHDMI inputs
- 3G-SDI input (optional, available on request)
- DisplayPort input up to 2560x1600 (60Hz)
- Analog RGB/VGA input capture up to 205MHz
- Video input (CVBS, S-Video, Component Video)
- RS232 remote control capability (Remote OSD via WIN-PC) (optional, available on request)
- Lead-free

4. Hardware Features

High-Quality Advanced Scaling

- Moiré cancellation
- Motion Adaptive De-interlacing
- Motion Adaptive Noise Reduction
- Low Angle Diagonal Interpolation

Analog RGB Input

- Supports up to 1792x1344@60Hz or 1920x1280@60Hz or 1600x1200@75Hz standard modes
- Supports up to 1920x1440@60Hz or 2128x1200@ 60Hz with reduced blanking
- Captures up to 205MHz

Ultra-Reliable HDMI Receivers

- Two single Link TMDS Rx for up to 12-bit 1080p (16-bit supported but dithered)
- Direct connect to all HDMI 1.3 and 1.4 compliant TMDS transmitters
- HDCP support

DisplayPort Receiver

- 10.8Gbps total bandwidth over 4 lanes
- 2560x1600@60Hz input support at 12-bit
- HDCP support

Optional: SDI Receiver

- Operation at 2.97Gb/s, 2.97/1.001Gb/s, 1.485Gb/s, 1.485/1.001Gb/s and 270Mb/s
- Supports SMPTE 425M (Level A and Level B), SMPTE 424M, SMPTE 292M, SMPTE 259M-C

Faroudja DCDI Cinema Format Conversion for Videoinput

- Low Angle De-interlacing processing
- Per Pixel Motion Adaptive De-Interlacing (MADi) up to 1080i format
- Format conversion up to WUXGA
- Panoramic and Anamorphic non-linear scaling
- Adaptive Media Display Processing for 3:2 and 2:2 video content
- Adaptive 3D noise reduction



Video Input

- Supports Composite Video, S-Video, and Component Video
- 3D Adaptive Comb Filter for Luma-Chroma separation of CVBS input
- Support for all broadcast TV Video standards – NTCS (North America and Japan), PAL (I, B, G, H, M, D, N), SECAM (D, K, L, B, G)
- Macrovision and VCR trick mode support

LVDS Interface

- Fully programmable LVDS mappings for compliance with all LVDS protocols

LCD Overdrive

- Reduces video smearing artifacts of rapid luminance transition scenes cause by slow LCD panel response

RealColor™ Technology

- Color filtering in YUV domain
- Digital brightness, contrast, hue and saturation control for analog, digital and video inputs

Auto-Configuration / Auto-Detection

- Phase and image positioning
- Input format detection

Frame Store

- Frame rate conversion
- Shrink scaling

On Screen Display

- Horizontal and vertical stretch of OSD images
- Blinking, transparency and blending
- 16 True Color bitmap tiles with 1, 2, 4, and 8-bit per pixel

Output Format

- Single/double wide LVDS up to WUXGA 60Hz output
- Support for 10, 8 or 6-bit panels (with high-quality dithering)

Operation Modes

- Frame rate conversion and scaling of images
- Bypass mode with no filtering and/or frame buffering
- 1:1 centering
- Frame Sync, Free Run and Auto Sync display synchronization modes

Audio Input

- 4 pairs of audio L/R inputs. 1 pair on RCA jacks (white/red) (CN15-CN16), 3 pairs on internal pin-header(CN7)

Audio Output

- Line output 700 mV_{eff} (2 V_{pp}) into 10 k Ω (CN5-CN6)
- Optional: 2W/ Ch (4 Ω) audio output (L/R) (CN5-CN6)
- Can output any one of the 4 L/R inputs or the embedded audios of 2xHDMI, DisplayPort

PSU Power Save Function

- Control of external power supply unit with low-power mode, through GPIO
- +5V low-power output of the PSU can be connected through CN802 pin-1 (+5V) and pin-2 (GND). Control pin of the PSU can be connected through CN202 pin-2 (EXT_GPIO_0) and pin-12 (GND).
- During normal-operation/input-search/input-not-supported/sleep states, the GPIO will be low (GND). During power-off mode, the GPIO will be high (+3.3V).
- Decreased total system power consumption during power-off mode
- Caution: May require testing with particular power supplies
- See Appendix B for timing details



5. Input / Output Interfaces

The following drawing shows the input and output interfaces of the PRISMAMEDIA-II. The design is implemented as a single printed circuit board.

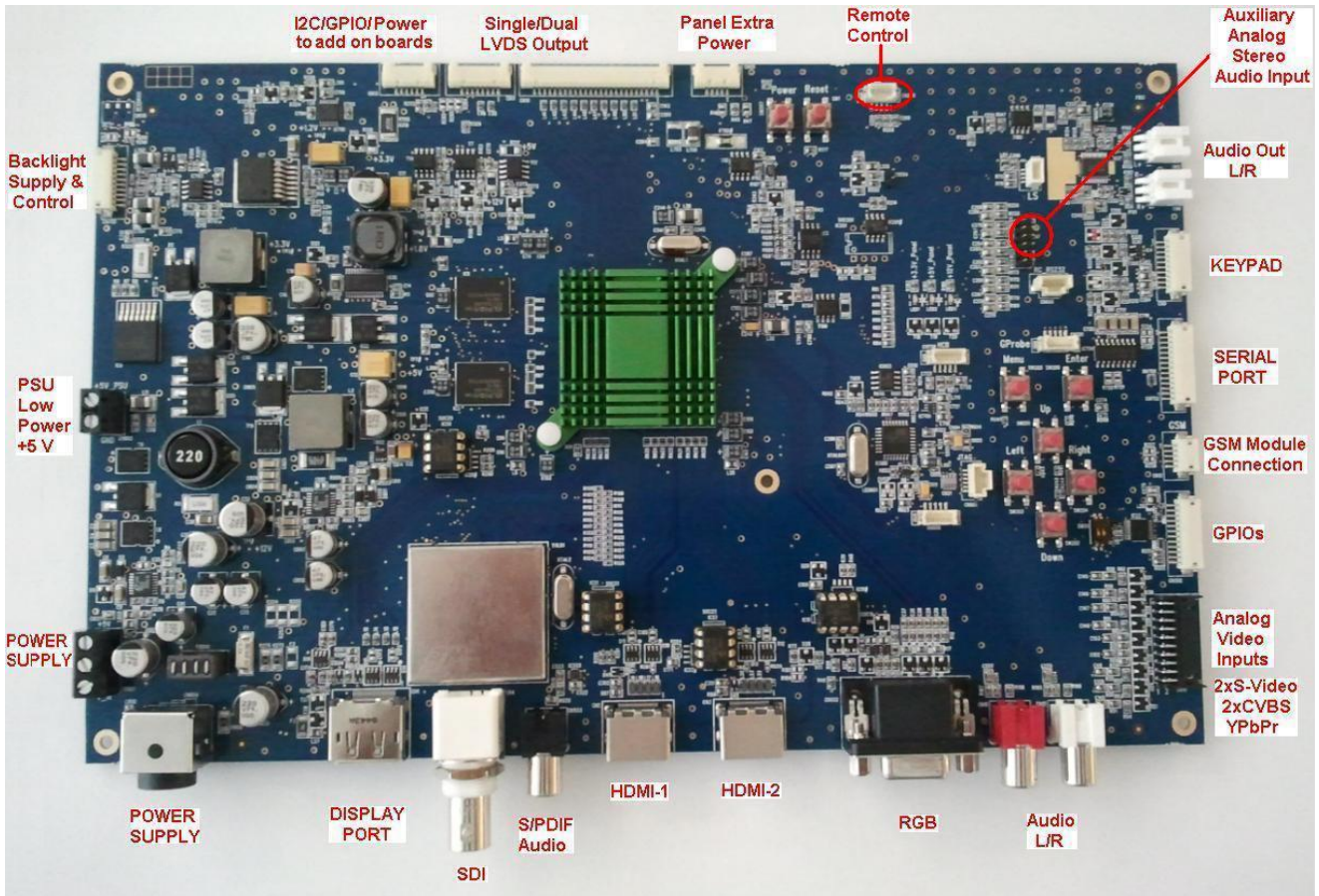

On-board OSD buttons can be equipped on top or bottom side (default top).



6. OSD Menu and User Controls

The OSD allows selection of input source and fine tuning of various functional parameters like brightness, contrast etc. These parameters can be adjusted by onboard push buttons or via an external interface. Push buttons can be equipped on top or bottom side of the PrismaMEDIA-II. In that case no external OSD-board is necessary. Depending on the mounting of the PrismaMEDIA-II in the casing, the onboard OSD control can simplify the construction of the casing.

6.1 On-Board OSD Control

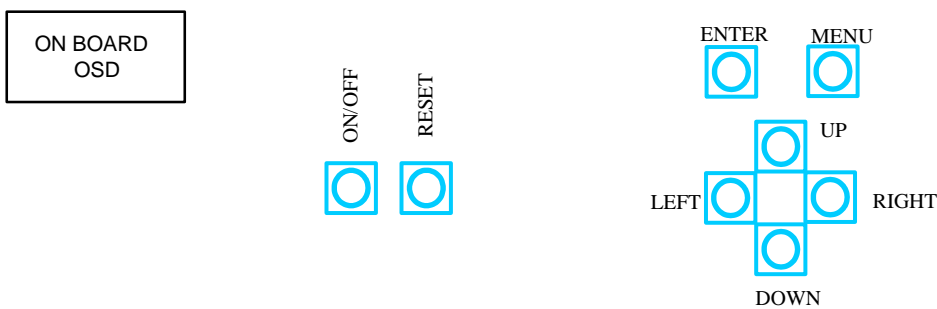

Key	Function
POWER	Switch Power On / Off
RESET	Reset PrismaMEDIA-II to last saved state

The six buttons of the OSD control can either be used to navigate within the OSD or to access various functions directly. The following two tables give you an overview about the functionality.

Key	Function	Remark
Up	Opens main input selection menu	
Down	Opens PIP/PAP input selection menu	If PIP/PAP is open
Left	Brightness down	
Right	Brightness up	
Menu	Opens the OSD Main Menu	
Enter	No function	

Functionality while OSD is closed



Key	Function	Remark
MENU	Leave OSD main menu	
	Leave submenu	Go to upper menu
	Leave function	
ENTER	Opens selected menu	
	Opens selected sub-menu	
	Enables selected operation	In selected functions
UP	Moves up through menu / sub-menu / functions	In open OSD menu
	Select next sub-menu item	Select next submenu item & toggle next item selection
DOWN	Moves down through menu / sub-menu / functions	In open OSD menu
	Select previous sub-menu item	Select previous submenu item & toggle next item selection
LEFT	Exits current sub-menu / function.	Go to upper menu
	Decreases set value of function slider or cycles left through possible operation modes	When a function is selected
RIGHT	Enters current sub-menu / function.	
	Increases set value of function slider or cycles right through possible operation modes	When a function is selected

Functionality while OSD is open

The status LED on the external interface and the two LEDs on the PRISMAMEDIA-II show the current status of the board:

Color	Meaning
Green	Normal operation
Fast Green Blink	Input Search
Slow Green Blink	Input signal not supported
Red	Power off
Green & Red	Sleep Mode

Status LEDs



6.2 OSD Control Through External Keypad

For users that wish to use an external OSD control, a keypad with OSD control buttons is available.

User can use all OSD functions with up/down/left/right/enter/exit keys.

A typical external keypad:

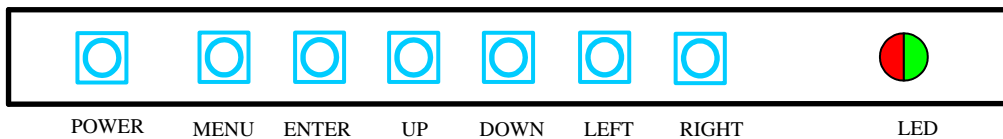
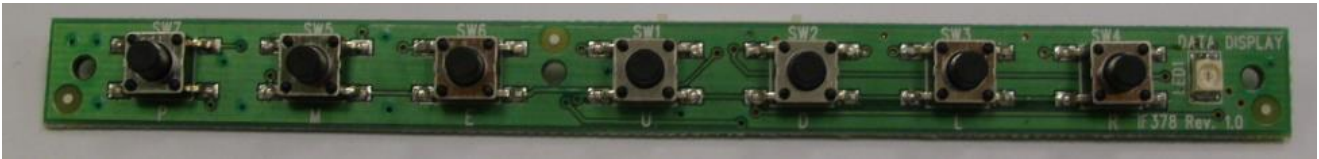

Controls are the same as on-board buttons.

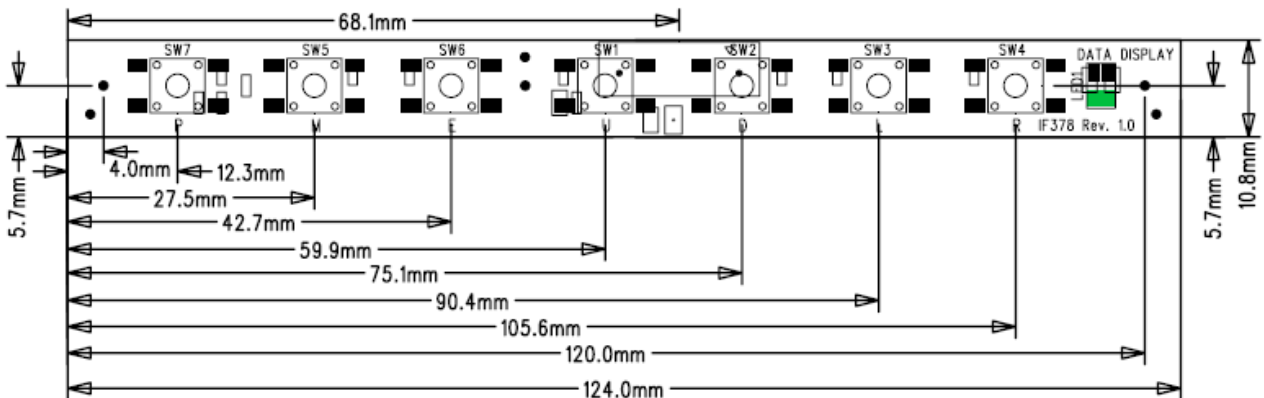

All dimensions are in mm.



6.3 OSD Control through IR Remote Control













Alternative to internal/external keypads, the PrismaMEDIA-II can also be controlled through a remote control device. In order to communicate through IR, an IR-amplifier can be attached through connector CN200 of the PrismaMEDIA-II. Detailed information on the connector can be found under chapter 9.



Remote controller functionality:

Rubber key marking	Chase marking	hex code	Functions
	Power	0x01	Power on/off board
		0x37	
		0x38	
		0x39	
		0x3a	
		0x3b	
		0x3c	
		0x3d	
		0x3e	
		0x3f	
		0x36	
	PAP	0x0B	



			0x0C	
			0x32	
			0x33	
			0x34	
	Mute		0x05	
	Volume		0x04	Increase volume while OSD is closed
			0x03	Decrease volume while OSD is closed
	Brightness		0x30	Increases brightness while OSD is closed
			0x31	Decreases brightness while OSD is closed
			0x0D	Moves up through possible selections, Switch main input port while OSD is closed
			0x11	Moves down through possible selections, Switch pip input port while OSD is closed
			0x0E	Exits current sub-menu / function (goes to upper menu), Moves left through possible selections or slider, Decrease brightness while OSD is closed
			0x10	Enters current sub-menu / function, Moves right through possible selections or slider, Increase brightness while OSD is closed
			0x0F	Enters chosen function
M	Source		0x23	
P	Source		0x24	
blank	Menu		0x27	Opens OSD
blank	Exit		0x13	Closes OSD
blank	Freeze		0x1A	Freeze image



blank	Auto	0x21	Auto-configuration for VGA input
blank	Aspect Main	0x17	Changes Aspect in Main View
blank	Aspect PIP	0x0A	Changes Aspect in PIP View
blank	PIP Select	0x14	Switches between PIP on and off
blank	PIP Swap	0x02	Swaps input of main and PIP, when PIP is open
blank	PIP Size	0x15	Switches PIP size(small, large)
blank	PIP Position	0x16	Switches between 4 PIP position (left-top, left-bottom, right-top, right-bottom)

6.4 Input Selection

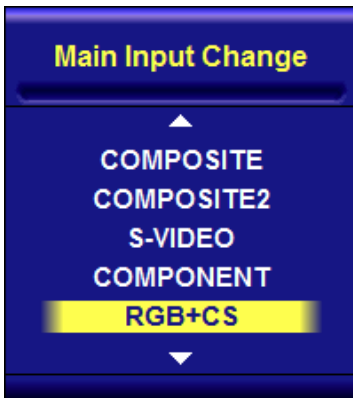

When the OSD is closed press the UP key on your keypad or button "M" on your IR remote control. This opens the dialog shown on the left where you can manually switch to a specific input port. Note that only ports which are enabled in the FW can be selected in this dialog.

If you have PIP enabled (see sec. 7.2) then you can in the same way change the PIP input port: When the OSD is closed press the DOWN key on your keypad or button "P" on your IR remote control. This opens a dialog similar to the one on the left.



7. On-Screen-Menu (OSM)

7.1 Sub-Menu "Image Settings"



Figure 7.1.a "Image Settings" menu for S-Video, CVBS and graphics mode of DVI/HDMI.

Figure 7.1.b "Image Settings" menu for VGA, YPbPr and video mode of DVI/HDMI.

Scheme: Switches between normal/sport/game/cinema/vivid preset values. Each scheme has particular brightness, contrast, etc. values.

Brightness: Brightness of the image can be controlled using this function, with left and right buttons after the brightness slider is selected. This function modifies RGB data to change the brightness.

Contrast: Allows <Contrast> adjustment in the Y domain. The modification affects all color channels and all input types and is a direct multiplication of the Y data after YUV black level adjustment.

Hue: Allows <Hue> adjustment in the UV domain. The modification affects all color channels and all input types.

Saturation: Allows <Saturation> adjustment in the UV domain. The modification affects all color channels and all input types.

Sharpness: Allows <Sharpness> adjustment on the image.

Advanced: The advanced menu opens in two different ways, according to input type:



Figure 7.1.c "Advanced" menu for S-Video, CVBS, YPbPr and video mode of DVI/HDMI.
Figure 7.1.d "Advanced" menu for VGA and graphics mode of DVI/HDMI.

- **Color:**



Figure 7.1.e "Color" menu for DVI/HDMI and SDI
Figure 7.1.f "Color" menu for S-Video, CVBS, YPbPr, RGB+CS and VGA

- **Color Temp:** Allow selection of different color temperature schemes.
- **User Color:** If the user has a preference other than the pre-set color temperatures, the menu below can be used to create a new color scheme.
- **ADC Calibration:** Performs an auto fine tuning on the ADC. Does not apply to digital inputs.

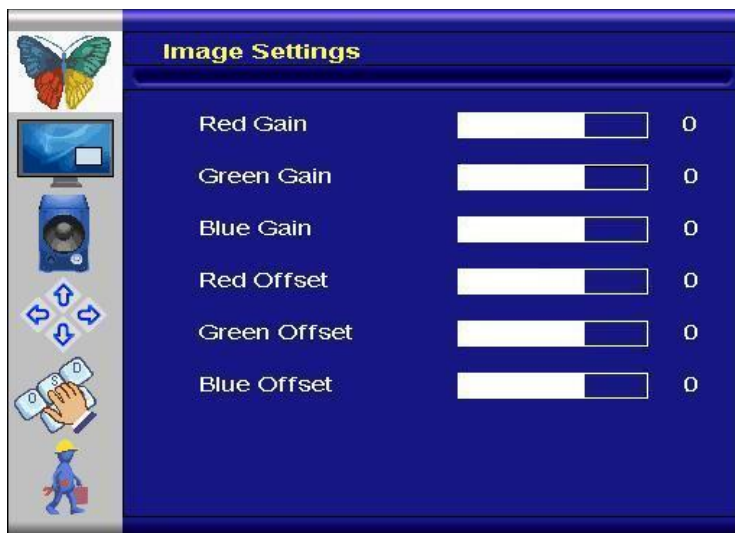

- **Red Gain:** Boost adjustment on red.
- **Green Gain:** Boost adjustment on green.
- **Blue Gain:** Boost adjustment on blue.
- **Red Offset:** Base level increase on red.
- **Green Offset:** Base level increase on green.
- **Blue Offset:** Base level increase on blue.

- **Noise Reduction:**

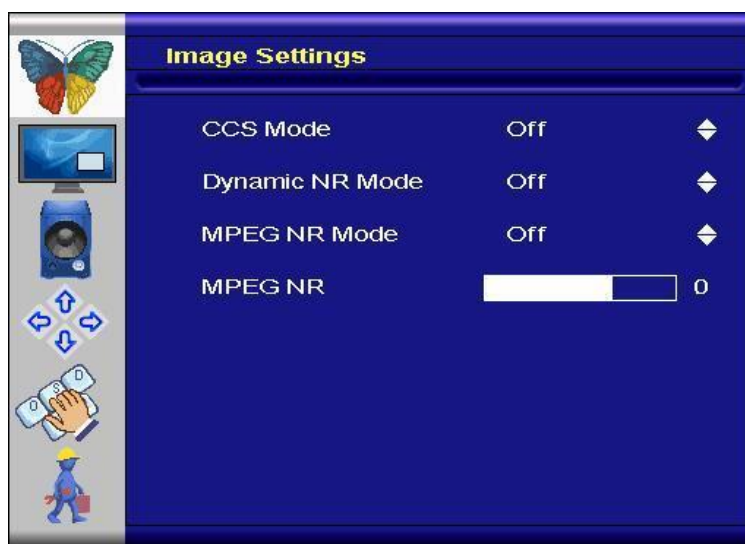

- **CCS Mode:** Changes Cross-Color Suppression between off/adaptive/normal. Adjust for best image.
- **Dynamic NR Mode:** Changes Dynamic Noise Reduction between low/medium/high/off/adaptive. High setting may cause loss of detail, adjust f for best image.
- **MPEG NR Mode:** Enables/disables the MPEG NR Mode.
- **MPEG NR:** Allow user to manually set the level of MPEG noise reduction.



- **Video Processing:**

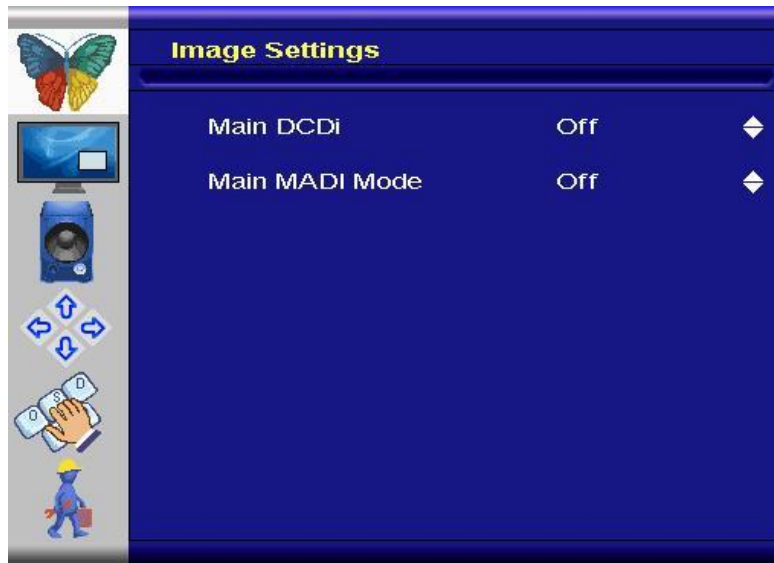

- **Main DCDi:** Turns DCDi on/off on main channel.
- **Main MADI Mode:** Changes Motion Adaptive De-Interlacing between normal/off/adaptive modes.

- **Film Mode:** This feature can be used to adjust image when viewing 2:2/3:2 pulled-down video camera films.



- **Film Mode Detection:** Selection of Video-3:2/Video-2:2/Video-3:2-2:2/off.
- **Film Display Mode:** Selection of Normal 3:2.

Reset Scheme: Can be used to reset scheme (normal/sport/game/cinema/vivid) settings to factory value.



7.2 Sub-Menu "Display Settings"



Aspect Ratio: Used to adjust display between full screen, Letter Box Expand and Pillar Box.

When a film or video that was not originally designed for widescreen is shown on a widescreen display, black bars are placed on the sides of the image. This is called *pillar boxing*. *Letterboxing* is the practice of transferring a film shot in a widescreen aspect ratio to standard-width video formats while preserving the film's original aspect ratio, by placing black bars above and below the image.

1:1 is a technique that captures images without changing resolution. The input resolution can not be bigger than the panel resolution in horizontal or vertical.



PIP: Picture-In-Picture can be used to display HDMI/DVI and another input at the same time.

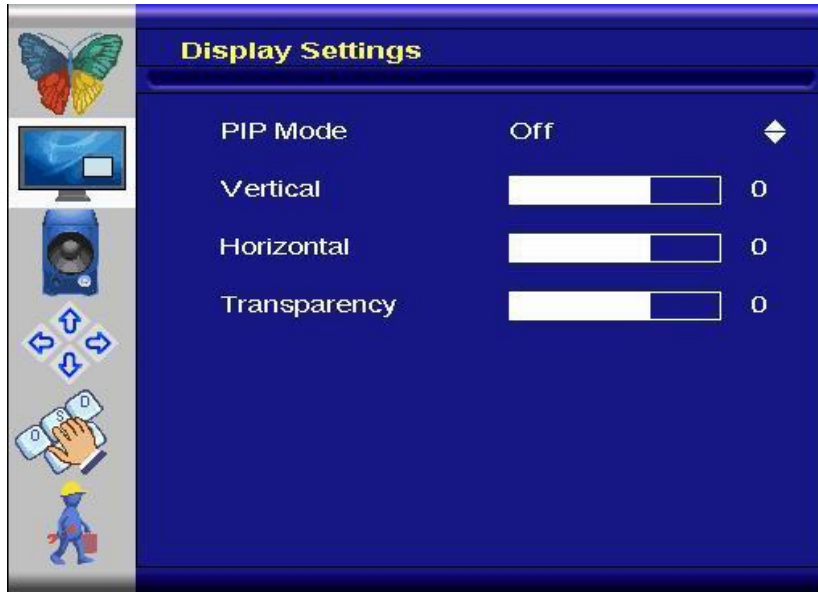

PIP mode can be toggled between Off, PAP-Tall, Side-by-side, Small PIP and Large PIP. PIP position and transparency can be adjusted using the slider bars.

The following matrix shows the possible combinations of Main- and PIP Channels:
Note that not all listed ports are available on all variants of PrismaMEDIA-II.

		Main Channel									
		VGA	YPbPr ¹⁾	RGB CS ²⁾	CVBS1	CVBS2	S-Video1	S-Video2	HDMI1	HDMI2	DP
PiP	VGA	*	✓	✓	✓	✓	✓	✓	✓	✓	✓
	YPbPr ¹⁾	✓	*	✗	✓	✓	✓	✓	✓	✓	✓
	RGB CS ²⁾	✓	✗	*	✗	✗	✗	✗	✓	✓	✓
	CVBS1	✓	✓	✗	*	✗	✗	✗	✓	✓	✓
	CVBS2	✓	✓	✗	✗	*	✗	✗	✓	✓	✓
	S-Video1	✓	✓	✗	✗	✗	*	✗	✓	✓	✓
	S-Video2	✓	✓	✗	✗	✗	✗	*	✓	✓	✓
	HDMI1	✓	✓	✓	✓	✓	✓	✓	*	✗	✓
	HDMI2	✓	✓	✓	✓	✓	✓	✓	✗	*	✓
	DP	✓	✓	✓	✓	✓	✓	✓	✓	✓	*

* One input port can be displayed simultaneously on Main and PiP channel.

1) Component

2) RGB with Composite Sync



Tiling: The tiling function (for video wall applications) can be used with all input types.

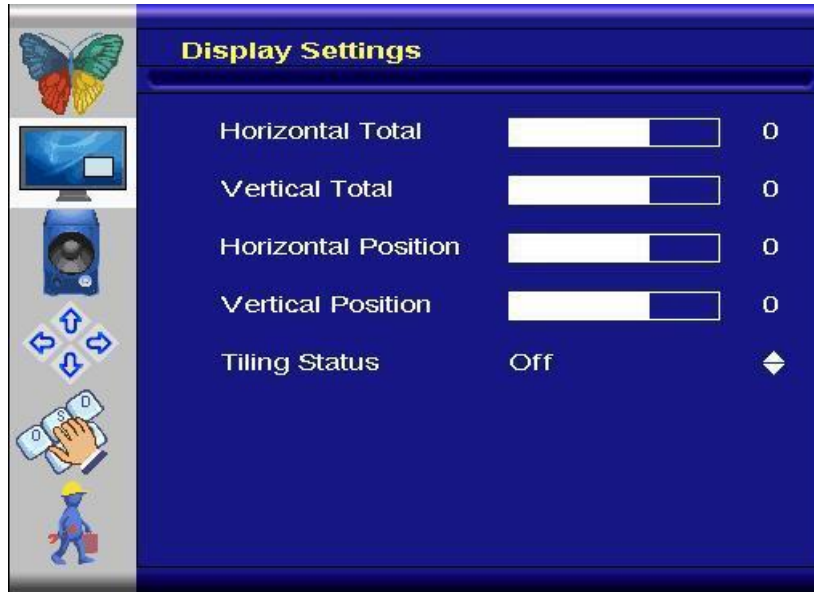

Horizontal Total: Defines the total horizontal number of displays.

Vertical Total: Defines the total vertical number of displays.

Horizontal Position: Defines the horizontal position of the actual display unit.

Vertical Position: Defines the vertical position of the actual display unit

Tiling Status: Enables/disables the tiling function. If the PIP-Mode is PAP-Tall or side-by-side, the tiling status will be off and disabled.

Example: 3 by 3 video wall: Definition of **Horizontal/Vertical** display position:

Horizontal Vertical	1	2	3
1	1/1	2/1	3/1
2	1/2	2/2	3/2
3	1/3	2/3	3/3

Limitations:

- Tiling property cannot be used while PAP-tall or Side-by-Side modes are active.
- If PIP is turned on, the PIP image would be displayed on every panel of the video wall.
- Image and position menus are disabled while tiling is on.

Note:

- For best results the Horizontal Total and Vertical Total has to be set to the values which is one of the integer dividers of the input width/height. For example if input is 1280x768 horizontal total has to be set to 2, 4, 5, 8 and vertical total has to be set to 2, 3, 4, 6, 8.



7.3 Sub-Menu "Audio Settings"



Volume: Adjusts volume.

Balance: Adjusts balance.

Bass: Adjusts bass.

Treble: Adjusts treble.

Stereo : Used to adjust volume between mono and stereo.

Speakers: Enables/disables (Main/ off) the speakers.



Audio inputs:



- **VGA:** Assigns the VGA audio input to either the primary input (CN15/CN16) or any of 3 additional audio inputs (CN7) or turns it OFF
- **SDI:** Assigns the SDI audio input to either the primary input (CN15/CN16) or any of 3 additional audio inputs (CN7) or turns it OFF
- **HDMI1:** Assigns the HDMI1 audio input to either the internal HDMI1 (CN2) audio or the primary input (CN15/CN16) or any of 3 additional audio inputs (CN7) or turns it OFF
- **HDMI2:** Assigns the HDMI2 audio input to either the internal HDMI2 (CN3) audio or the primary input (CN15/CN16) or any of 3 additional audio inputs (CN7) or turns it OFF
- **DISPLAYPORT:** Assigns the DP audio input to either the internal DP (CN1) audio or the primary input (CN15/CN16) or any of 3 additional audio inputs (CN7) or turns it OFF
- **COMPOSITE1:** Assigns the Composite1 audio input to either the primary input (CN15/CN16) or any of 3 additional audio inputs (CN7) or turns it OFF
- **COMPOSITE2:** Assigns the Composite2 audio input to either the primary input (CN15/CN16) or any of 3 additional audio inputs (CN7) or turns it OFF
- **S-VIDEO1:** Assigns the S-Video1 audio input to either the primary input (CN15/CN16) or any of 3 additional audio inputs (CN7) or turns it OFF
- **S-VIDEO2:** Assigns the S-Video2 audio input to either the primary input (CN15/CN16) or any of 3 additional audio inputs (CN7) or turns it OFF
- **COMPONENT:** Assigns the Component audio input to either the primary input (CN15/CN16) or any of 3 additional audio inputs (CN7) or turns it OFF



7.4 Sub-Menu "Position Settings"



Figure 7.4.a "Position Settings" menu for video mode of HDMI, s-video, composite and component inputs.

Width: Adjusts total width of the image by stretching or shrinking.

Height: Adjusts total height of the image by stretching or shrinking.

Horizontal Start: Changes the starting point of the image horizontally, without altering height.

Vertical Start: Changes the starting point of the image vertically, without altering width.

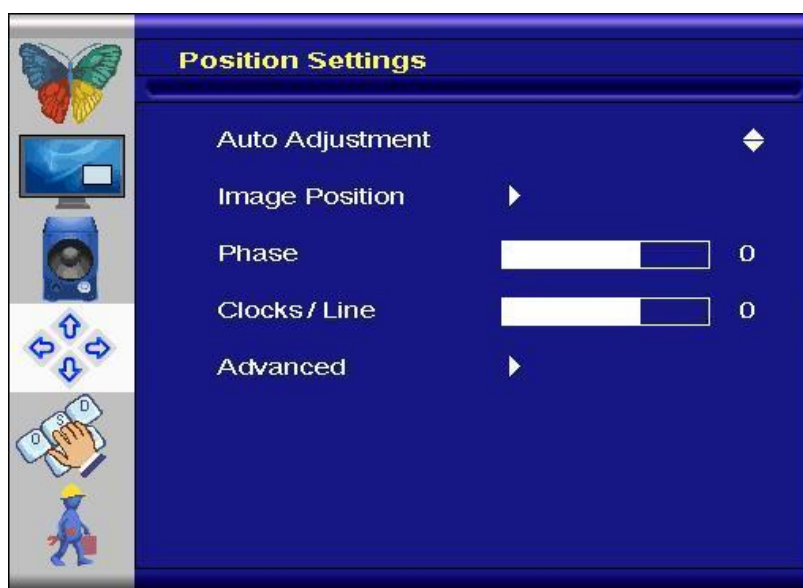
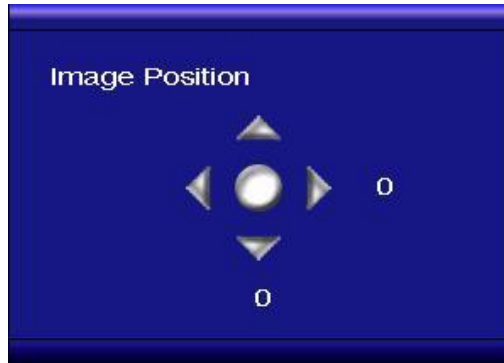

Figure 7.4.b : "Position Settings" Menu for VGA

Auto Adjustment: Performs auto-adjust function on the image.



Image Position: Used to alter placement of the image.



Phase: This function is a slider to adjust the sampling phase of the analog interface. For optimum image quality, input pixels should be sampled at the ideal sampling points.

Clocks/Line: This function is a slider to adjust the sample clock of the analog interface. This is helpful for improving the image quality for non-standard display modes.

Advanced:



This function can be used to manually force some of the widely used difficult-to-detect modes which can be mis-interpreted by the controller.



(For graphics mode of HDMI)





7.5 Sub-Menu "OSD Settings"

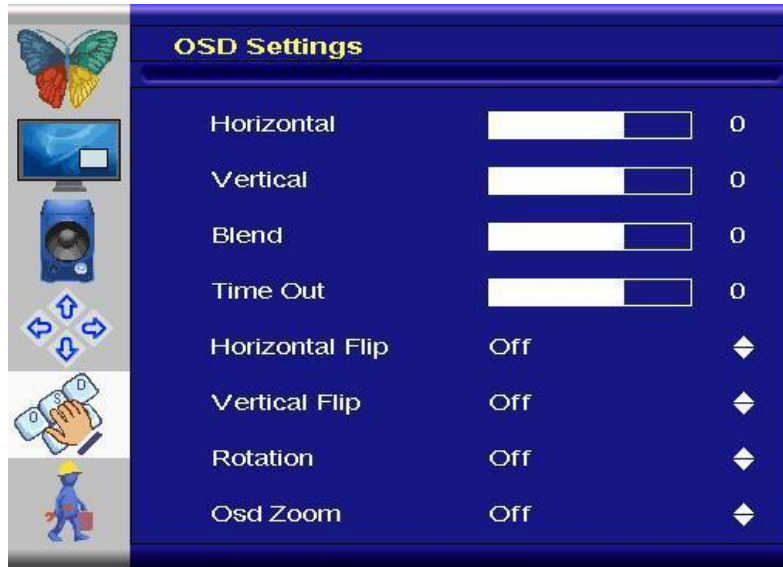

- Horizontal:** This function can be used to move the OSD window on a horizontal line.
- Vertical:** This function can be used to move the OSD window on a horizontal line.
- Blend:** This function can be used to change the transparency of the OSD window.
- Time Out:** This function determines after how many seconds the OSD will close itself.
- Horizontal Flip:** Flips the OSD on the horizontal.
- Vertical Flip:** Flips the OSD on the vertical.
- Rotation:** Rotates the OSD
- OSD Zoom:** Changes OSD size



7.6 Sub-Menu "Setup"

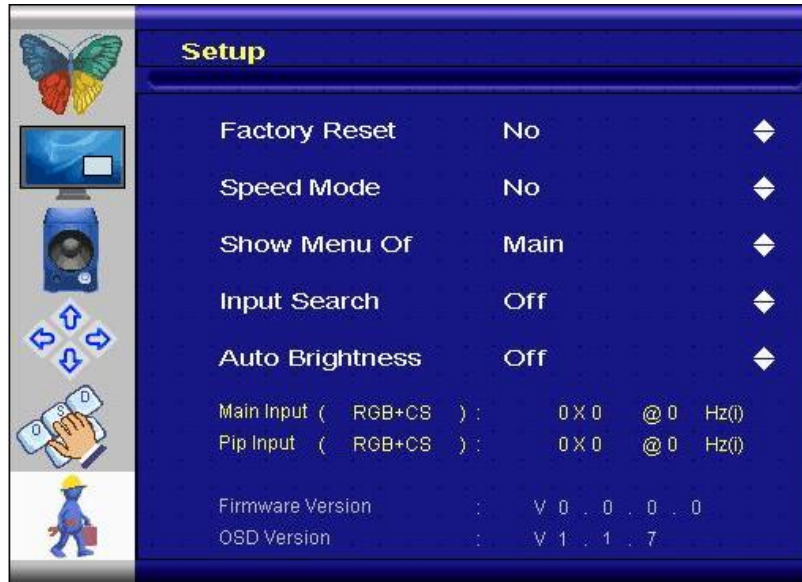

- Factory Reset:** This function can be used to load back factory-loaded values.
- Speed Mode:** In graphics mode, fast image transfer is supported.
- Show Menu Of:** Changes the menu between main image and PIP if the PIP mode is on.
- Input Search:** Toggles input search on/off.
- Auto Brightness:** (Optional) Toggles automatic brightness control through external light sensor on/off.



8. Supported Input Modes

The PrismaMEDIA-II can support the following input modes.

8.1 S-Video – CVBS

There are two S-Video and two CVBS connections through the side video connector CN14. The following table shows the basic characteristics of the supported standard video formats.

Resolution
720 x 480 @ 30(i) (NTSC)
720 x 576 @ 25(i) (PAL)

8.2 Component

The PrismaMEDIA-II accepts Component Video Input (YPbPr) through the side video connector CN14.

Resolution	Resolution
720 x 240 @ 30(i)	1920 x 540 @ 25(i)
720 x 480 @ 60	1920 x 540 @ 30(i)
720 x 288 @ 25(i)	1920 x 1080 @ 25
720 x 576 @ 50	1920 x 1080 @ 30
1280 x 720 @ 50	1920 x 1080 @ 50
1280 x 720 @ 60	1920 x 1080 @ 60

8.3 VGA

The PrismaMEDIA-II is equipped with one VGA connector CN502. The factory preset supported input modes include:

Resolution	Resolution
640 x 480 @ 60 Hz (VESA)	1366 x 768 @ 60 Hz
800 x 600 @ 60 Hz (VESA)	1368 x 768 @ 60 Hz
1024 x 768 @ 60 Hz (VESA)	1600 x 1200 @ 60 Hz (VESA)
1280 x 768 @ 60 Hz	1920 x 1200 @ 60 Hz
1280 x 1024 @ 60 Hz (VESA)	1920 x 1080 @ 60 Hz
1360 x 768 @ 60 Hz	



8.4 HDMI – Graphics

The PrismaMEDIA-II is equipped with two HDMI connectors CN2 and CN3. The factory preset supported input modes include:

Resolution	Resolution
640 x 480 @ 60 Hz (VESA)	1366 x 768 @ 60 Hz
800 x 600 @ 60 Hz (VESA)	1368 x 768 @ 60 Hz
1024 x 768 @ 60 Hz (VESA)	1600 x 1200 @ 60 Hz (VESA)
1280 x 768 @ 60 Hz	1920 x 1200 @ 60 Hz
1280 x 1024 @ 60 Hz (VESA)	1920 x 1080 @ 60 Hz
1360 x 768 @ 60 Hz	

8.5 HDMI – Video

The factory preset supported input modes include:

Resolution	Resolution
720 x 480 @ 60	1920 x 1080 @ 24
720 x 576 @ 50	1920 x 1080 @ 50
1280 x 720 @ 50	1920 x 1080 @ 60
1280 x 720 @ 60	

8.6 SDI (Option)

The PrismaMEDIA-II can optionally be equipped with one SDI connector CN4. The factory preset supported input modes include:

Resolution	Resolution
720 x 480 @ 60	1920 x 1080 @ 24
720 x 576 @ 50	1920 x 1080 @ 50
1280 x 720 @ 50	1920 x 1080 @ 60
1280 x 720 @ 60	

8.7 DP

The PrismaMEDIA-II is equipped with one DP connector CN1. The factory preset supported input modes include:

Resolution	Resolution
640 x 480 @ 60 Hz (VESA)	1366 x 768 @ 60 Hz
800 x 600 @ 60 Hz (VESA)	1368 x 768 @ 60 Hz
1024 x 768 @ 60 Hz (VESA)	1600 x 1200 @ 60 Hz (VESA)
1280 x 1024 @ 60 Hz (VESA)	1920 x 1200 @ 60 Hz
1360 x 768 @ 60 Hz	1920 x 1080 @ 60 Hz



9. Audio Support

There are 4 pairs of audio L/R inputs and 2W audio L/R output.

9.1 Audio Input

- Digital Inputs (embedded into Video interfaces and assigned to the corresponding Video input)
 - DisplayPort (DP)
 - HDMI-1
 - HDMI-2
 - 3G-SDI – Audio not supported
- Analog Inputs
 - Main analog stereo audio input (CN15 / CN16)
Default input for VGA, analog video inputs and SDI.
 - Three auxiliary analog stereo audio inputs (CN7)
No default assignment. Customer can assign VGA, analog video inputs or SDI to these auxiliary audio ports.

9.2 Audio Output

- Analog output via line output on CN5, CN6 is standard
- Output level 700 mV_{eff} (2 V_{pp}) into 10 k Ω load
- Optionally, an integrated stereo amplifier can be assembled (2x2W) for loudspeaker Output on CN5 , CN6
- Additional GPIO with mute function for external high-power amplifier available on request (customized firmware)

9.3 Extended Audio Input Assignment

- On project base there is the possibility to assign the three additional audio inputs (CN7) to any of the available video inputs
- This may be done hardcoded (customer specific firmware) or selectable through the OSD (On-Screen-Display) user interface



10. Absolute Maximum Ratings

Item	Symbol	Min.	Max.	Unit	Note
Supply Voltage	$V_{in(12V)}$	11.7	16	VDC	1, 2,3
	$V_{in(24V)}$	18	28	VDC	1,3,4
Storage Temperature	T_{St}	-35	+85	°C	
Operating Temperature	T_{Op}	0	+70	°C	

Note (1) Within operating temperature range.

Note (2) Supply voltage limits are for the PrismaMEDIA-II, panel/inverter supply limits must be met as well, if the panel is +12V and the inverter is to be powered through the PrismaMEDIA-II board.

Note (3) Permanent damage to the device may occur if maximum values are exceeded.

Note (4) Supply voltage limits are for the PrismaMEDIA-II; inverter supply limits must be met as well, if the inverter is to be powered through the PrismaMEDIA-II board.

There are two hardware versions of the PrismaMEDIA-II. One is for 12V input, and the other for 24V input. The following labels that can be seen on the products will tell the required input voltage. Also, the 'DISPLAY' and 'INVERTER' words show what is included in the kit. If the display has an integrated inverter, the label will say only 'DISPLAY'. If there is an external inverter in the kit, the label will say both 'DISPLAY' and 'INVERTER'.

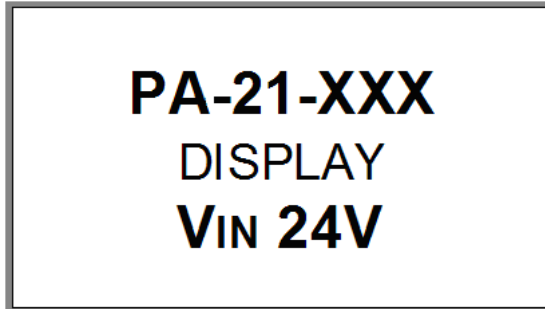
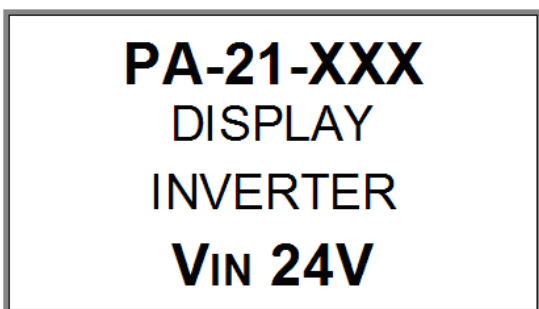
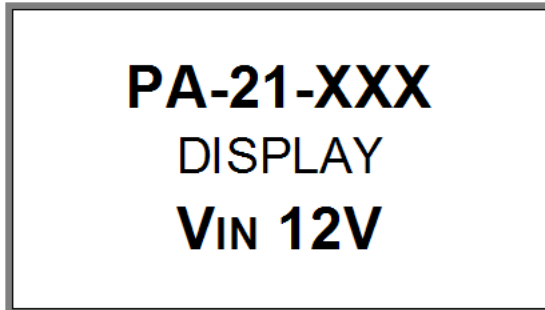
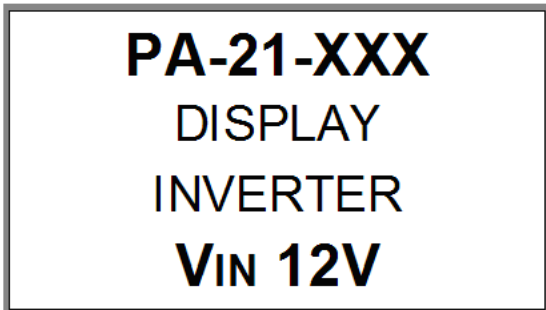

For example, the lower right label means the display has an integrated inverter, and the input voltage of the PrismaMEDIA-II has to be 24V.



11. Electrical Characteristics

Remark: All values are average values of repeated measurements. Other PrismaMEDIA-II types or PrismaMEDIA-II/panel combinations can have different electrical characteristics.

+12V input voltage:

Item	Condition	MIN.	TYP.	MAX.	Unit	Note
Supply Voltage		11.7	12.0	13.2	VDC	1
Current Consumption (12V)	Power-OFF	65	69	73	mA	2
	Sleep mode	360	380	405	mA	2
	Board only	540	566	600	mA	2
(CMO G150X1-L02 with BL1502044-06 inverter)	XGA	1.55	1.58	1.62	A	2
(Samsung LTA400HT-L03)	WUXGA	1.35	1.4	1.45	A	2,3

+24V input voltage:

Item	Condition	MIN.	TYP.	MAX.	Unit	Note
Supply Voltage		21.6	24.0	26.5	VDC	1
Current Consumption (24V)	Power-OFF	48	49	55	mA	2
	Sleep mode	210	220	230	mA	2
	Board only	290	302	320	mA	2
(Samsung LTA400HT-L03)	WUXGA	0.66	0.69	0.71	A	2,3

- 1) Supply voltage limits are for the PrismaMEDIA-II, inverter supply limits must be met as well, if the inverter is to be powered through the PrismaMEDIA-II board.
- 2) Control circuitry not assembled, standard board.
- 3) Inverter (24V) is externally powered. This value is for panel-power and board only.
- 4) All measurements done at 25°C ambient temperature.



12. Input Connectors

DISPLAYPORT CONNECTOR CN1		
Pin	Signal	Description
1	DP3- _IN	Pair-3 negative
2	GND	Ground
3	DP3+ _IN	Pair-3 positive
4	DP2- _IN	Pair-2 negative
5	GND	Ground
6	DP2+ _IN	Pair-2 positive
7	DP1- _IN	Pair-1 negative
8	GND	Ground
9	DP1+ _IN	Pair-1 positive
10	DP0- _IN	Pair-0 negative

Pin	Signal	Description
11	GND	Ground
12	DP0+ _IN	Pair-0 positive
13	GND	Ground
14	GND	Ground
15	DPA+ _IN	Aux channel positive
16	GND	Ground
17	DPA- _IN	Aux channel negative
18	HPD	Hot Plug Detect
19	Power Return	Return for +3.3V
20	+3.3V_DP	DisplayPort +3.3V

HDMI CONNECTOR-1 CN2		
Pin	Signal	Description
1	TMDS2+	Differential TMDS Data 2+
2	GND	Ground
3	TMDS2-	Differential TMDS Data 2-
4	TMDS1+	Differential TMDS Data 1+
5	GND	Ground
6	TMDS1-	Differential TMDS Data 1-
7	TMDS0+	Differential TMDS Data 0+
8	GND	Ground
9	TMDS0-	Differential TMDS Data 0-
10	TMDSCLK+	Differential TMDS Clock+

Pin	Signal	Description
11	GND	Ground
12	TMDSCLK-	Differential TMDS Clock-
13	CEC	Consumer Electronic Control
14	Reserved	
15	HDMI_SCL	DDC Clock
16	HDMI_SDA	DDC Data
17	GND	Ground
18	HDMI_VCC	+5V
19	Hot Plug	Hot Plug Detection



HDMI CONNECTOR-2 CN3		
Pin	Signal	Description
1	TMDS2+	Differential TMDS Data 2+
2	GND	Ground
3	TMDS2-	Differential TMDS Data 2-
4	TMDS1+	Differential TMDS Data 1+
5	GND	Ground
6	TMDS1-	Differential TMDS Data 1-
7	TMDS0+	Differential TMDS Data 0+
8	GND	Ground
9	TMDS0-	Differential TMDS Data 0-
10	TMDSCLK+	Differential TMDS Clock+

Pin	Signal	Description
11	GND	Ground
12	TMDSCLK-	Differential TMDS Clock-
13	CEC	Consumer Electronic Control
14	Reserved	
15	HDMI_SCL	DDC Clock
16	HDMI_SDA	DDC Data
17	GND	Ground
18	HDMI_VCC	+5V
19	Hot Plug	Hot Plug Detection

SDI CONNECTOR CN4 (optinal)		
Pin	Signal	Description
Center	SDI Video	Serial Digital Interface V

Pin	Signal	Description
Body	GND	Ground

SECONDARY AUDIO INPUT CONNECTOR CN7		
Pin	Signal	Description
1	AUD_L2_IN	Audio input channel 2 le
2	GND	Ground
3	AUD_R2_IN	Audio input channel 2 rig
4	GND	Ground
5	AUD_L3_IN	Audio input channel 3 le
6	GND	Ground

Pin	Signal	Description
7	AUD_R3_IN	Audio input channel 3 rig
8	GND	Ground
9	AUD_L4_I N	Audio input channel 4 left
10	GND	Ground
11	AUD_R4_I N	Audio input channel 4 right
12	GND	Ground

LOW POWER UART CONNECTOR CN8		
Pin	Signal	Description
1	TX_LPM	Serial Output
2	RX_LPM	Serial Input
3	+3.3V	3.3V Power supply

Pin	Signal	Description
4	+5V	5V Power supply
5	GND	Ground

OSD CONTROL PANEL CONNECTOR CN9		
Pin	Signal	Description
1	+3.3V_LBAD C	LBADC power line
2	GND	Ground
3	LBADC_IN2	+3.3V supply
4	GND	Ground
5	LED_RED	Status LED red (signal good)

Pin	Signal	Description
6	LED_GREEN	Status LED green (signal good)
7	POWER_ON/OFF	
8	+3.3V	+3.3V power
9	+5V	+5V power
10	GND	Ground



INTERFACE MODULE CONNECTOR CN13		
Pin	Signal	Description
1	+3.3V_SW	3.3V switched power sup
2	SCL	I2C clock
3	SDA	I2C data

Pin	Signal	Description
4	INTRFC_GPIO	
5	GND	Ground

VIDEO INPUT CONNECTOR CN14		
Pin	Signal	Description
1	Pb_IN	Component video Pb
2	GND	Ground
3	Y_IN	Component video Y
4	GND	Ground
5	Pr_IN	Component video Pr
6	GND	Ground
7	CVBS1_IN	CVBS input 1
8	GND	Ground
9	CVBS2_IN	CVBS input 2
10	GND	Ground

Pin	Signal	Description
11	S-VIDEO1-Y_IN	S-Video 1 luma
12	GND	Ground
13	S-VIDEO1-C_IN	S-Video 1 chroma
14	GND	Ground
15	S-VIDEO2-Y_IN	S-Video 2 luma
16	GND	Ground
17	S-VIDEO2-C_IN	S-Video 2 chroma
18	GND	Ground
19	+5V	+5V power
20	GND	Ground

AUDIO LEFT IN CONNECTOR CN15		
Pin	Signal	Description
Center	AUD_L1_IN	Left audio in

Pin	Signal	Description
Body	GND	Ground

AUDIO RIGHT IN CONNECTOR CN16		
Pin	Signal	Description
Center	AUD_R1_IN	Right audio in

Pin	Signal	Description
Body	GND	Ground

LIGHT SENSOR CONNECTOR CN17		
Pin	Signal	Description
1	+3.3V	+3.3V power
2	GND	Ground

Pin	Signal	Description
3	SCL	I2C clock
4	SDA	I2C data

Remote control IR-amplifier connector CN200		
Pin	Signal	Description
1	IR	Amplified IR signal
2	+3.3V	3.3V Power supply

Pin	Signal	Description
3	+5V	5V Power supply
4	GND	Ground

RGB – ANALOG INPUT CONNECTOR CN502		
Pin	Signal	Description
1	RED	Analog Red
2	GREEN	Analog Green
3	BLUE	Analog Blue
4	NC	Not connected
5	GND	Ground
6	GND	Ground
7	GND	Ground
8	GND	Ground

Pin	Signal	Description
9	VGA_5V	Fused VCC
10	GND	Ground
11	NC	Not Connect
12	VGA_SDA	DDC Data
13	HSYNC	Horizontal Sync Input
14	VSNC	Vertical Sync Input
15	VGA_SCL	DDC Clock



System Control LED out CN600 (optional)		
Pin	Signal	Description
1	+3.3V	3.3V Power supply
2	LED_DISPL	Display status check
3	LED_INV	Inverter status check

Pin	Signal	Description
4	NC	Not connected
5	GND	Ground

Remote System Control Program CN601 (optional)		
Pin	Signal	Description
1	MISO	
2	+3.3V	
3	PWM_FAN_E	

Pin	Signal	Description
4	PRX_CTRL	
5	RESET_ARCB	
6	GND	

Secondary controller serial connection CN606 (opt.)		
Pin	Signal	Description
1	RX_ARCB_IN	ATMega168 serial in
2	TX_ARCB_OUT	ATMega168 serial out
3	NC	Not connected

Pin	Signal	Description
4	NC	Not connected
5	NC	Not connected
6	GND	Ground

GProbe debug connector CN701		
Pin	Signal	Description
1	TX	Serial Output
2	RX	Serial Input
3	+3.3V	3.3V Power supply

Pin	Signal	Description
4	+5V	5V Power supply
5	GND	Ground

SERIAL COMMUNICATION CON. CN702		
Pin	Signal	Description
1	T1_OUT / TXD	RS232 / serial output port
2	R1_IN / RXD	RS232 / serial input port
3	NC	Not connected
4	NC	Not connected
5	NC	Not connected
6	NC	Not connected
7	DCD	Not connected

Pin	Signal	Description
8	DSR	Not connected
9	RTS	Not connected
10	DTR	Not connected
11	CTS	Not connected
12	+5V	+5V power supply
13	GND	Ground
14	NC	Not connected

* RS232 Rx / Tx signals: +/-12V typical, +/-5V minimum, and +/-15V absolute maximum rating.

External Current Sense Connector CN708 (opt.)		
Pin	Signal	Description
1	+3.3V	3.3V Power supply
2	GND	Ground
3	EXT_BOARD_DETE	

Pin	Signal	Description
4	VCC_INV_SENS	
5	NC	Not connected



POWER SUPPLY CONNECTOR CN800 (optional)		
Pin	Signal	Description
Center	+12V/+24V	12V/24V Power supply (up to 3A)
Bottom	GND	Ground

POWER SUPPLY CONNECTOR CN800#		
Pin	Signal	Description
1,2	+12V/+24V	12V Power supply (up to 7A)
3,4	GND	Ground

POWER SUPPLY CONNECTOR CN801		
Pin	Signal	Description
1	+5V	5V Power supply (option)
2	GND	Ground

PSU-LOW-POWER SUPPLY CONNECTOR CN802		
Pin	Signal	Description
1	+5V_PSU	+5V supply from PSU's standby mode low power output

Pin	Signal	Description
3	+12V/+24V	12V/24V Power supply (up to 5A)

Pin	Signal	Description
2	GND	Ground

13. Output Connectors

Connectors CN5, CN6 have different pinout depending on actual configuration! Please check your configuration (line out only or speaker output with integrated power amplifier) to determine actual pinout used!

LINE/SPEAKER LEFT OUT CONNECTOR CN5		
Pin	Signal	Description
1	+OUT_A	Line: Ground Speaker: Left audio positive

Pin	Signal	Description
2	-OUT_A	Line: Left audio output Speaker: Left audio negative

LINE/SPEAKER RIGHT OUT CONNECTOR CN6		
Pin	Signal	Description
1	+OUT_B	Line: Ground Speaker: Right audio positive

Pin	Signal	Description
2	-OUT_B	Line: Right audio output Speaker: Right audio negative



LVDS CONNECTOR CN10		
Pin	Signal	Description
1	SVCC	Switched panel power supply +3,3V/ +5V/ +12V (fused)
2		
3	GND	Ground
4		
5	TXB3+	LVDS data 1st pixel
6	TXB3-	LVDS data 1st pixel
7	TXBCL+	LVDS clock 1st pixel
8	TXBCL-	LVDS clock 1st pixel
9	TXB2+	LVDS data 1st pixel
10	TXB2-	LVDS data 1st pixel
11	TXB1+	LVDS data 1st pixel
12	TXB1-	LVDS data 1st pixel
13	TXB0+	LVDS data 1st pixel

Pin	Signal	Description
14	TXB0-	LVDS data 1st pixel
15	TXA3+	LVDS data 2nd pixel
16	TXA3-	LVDS data 2nd pixel
17	TXACL+	LVDS clock 2nd pixel
18	TXACL-	LVDS clock 2nd pixel
19	TXA2+	LVDS data 2nd pixel
20	TXA2-	LVDS data 2nd pixel
21	TXA1+	LVDS data 2nd pixel
22	TXA1-	LVDS data 2nd pixel
23	TXA0+	LVDS data 2nd pixel
24	TXA0-	LVDS data 2nd pixel
25	EBKL	Enable backlight signal

*LVDS channels A and B can be swapped upon request from customer.

SECONDARY LVDS CONNECTOR for 10-bit CN11		
Pin	Signal	Description
1	GND	Ground
2	TXB4+	LVDS data 1st pixel
3	TXB4-	LVDS data 1st pixel
4	TXA4+	LVDS data 2nd pixel

Pin	Signal	Description
5	TXA4-	LVDS data 2nd pixel
6*	LVDS_OPT_1	+3.3V/GND selectable
7*	LVDS_OPT_2	+3.3V/GND selectable
8*	LVDS_OPT_3	+5V/+3.3V/GND selectable

* +3.3V not available during full power-off mode

GSM MODULE CONNECTOR CN12		
Pin	Signal	Description
1	+5V	5V power supply
2	SCL	I2C clock
3	SDA	I2C data

Pin	Signal	Description
4	GSM_GPIO	
5	GND	Ground

PANEL EXTRA POWER CONNECTOR CN20		
Pin	Signal	Description
4,5	GND	Ground
2,3	SVCC	Switched panel power supply +3,3V/ +5V/ +12V (fused)
1	Jumper selectable voltage	Selectable +3.3V/+5V/GND



COAXIAL AUDIO OUT CON. CN503		
Pin	Signal	Description
Center	S/PDIF	Digital Audio Out

Pin	Signal	Description
Body		

BACKLIGHT SUPPLY CONNECTOR CN700		
Pin	Signal	Description
1	+12V/+24V	Backlight power supply
2	GND	Ground
3	EBKL	Enable backlight signal
4	BR_CTRL	Brightness control signal
5	+5V	5V power supply

Pin	Signal	Description
6	+5V	5V power supply
7	+12V/+24V	Backlight power supply
8	+12V/+24V	
9	GND	Ground
10	GND	

14. I/O Connector

There are 8 GPIOs connected to CN202, which can be configured as either or output, using custom firmwares. There also is an I2C line, for control of external I2C devices.

GPIO CON. CN202		
Pin	Signal	Description
1	+5V	5V power supply
2	EXT_GPIO_0	External GPIO 1
3	EXT_GPIO_1	External GPIO 2
4	EXT_GPIO_2	External GPIO 3
5	EXT_GPIO_3	External GPIO 4
6	EXT_GPIO_4	External GPIO 5

Pin	Signal	Description
7	EXT_GPIO_5	External GPIO 6
8	EXT_GPIO_6	External GPIO 7
9	EXT_GPIO_7	External GPIO 8
10	SCL	I2C Clock
11	SDA	I2C Data
12	GND	Ground

*External GPIO pins are open-drain, pulled up to 3.3V by 4.7kohm resistor



15. Connector Overview

CN	DESCRIPTION	TYPE	MANUFACTURER
CN1	DisplayPort Input	47272-0001	Molex
CN2	HDMI Input-1	47151-1001	Molex
CN3	HDMI Input-2	47151-1001	Molex
CN4	SDI Input	73100-0069 (BNC)	Molex
CN5	Line/Speaker left out	53426-0210	Molex
CN6	Line/Speaker right out	53426-0210	Molex
CN7	Secondary Audio Input	2mm pin-header dual row	e.g. Nexus
CN9	OSD Control	DF13-10P-1.25H	Hirose
CN10	Dual LVDS	DF14-25P-1.25H	Hirose
CN11	Secondary LVDS	DF14-5P-1.25H	Hirose
CN12	GSM Module	DF13-5P-1.25H	Hirose
CN13	Interface Module	DF14-5P-1.25H	Hirose
CN14	Video Inputs	DF11-20DP-2DS	Hirose
CN15	Audio Left In	RJ1515-1WH (RCA)	Nexus
CN16	Audio Right In	RJ1515-1R (RCA)	Nexus
CN17	Light Sensor	501331-0407	Molex
CN20	Additional LVDS power	DF14-5P-1.25H	Hirose
CN200	Infrared Remote Control	DF13B-4P-1.25V	Hirose
CN202	External GPIO/I2C	DF13-12P-1.25H	Hirose
CN502	VGA Input	15-pin H-DSUB female	---
CN503	Coaxial S/PDIF out	RJ1515-1BL (RCA)	Hirose
CN600	System control LEDs	DF13-5P-1.25V	Hirose
CN601	SPI-Programming	501331-0607	Molex
CN606	ATMega8 serial	501331-0607	Molex
CN700	Backlight Power Supply	DF13-10P-1.25H	Hirose
CN701	Gprobe	DF13B-5P-1.25V	Hirose
CN702	Serial Programming / RS232 Remote Control	DF13-14P-1.25H	Hirose
CN708	External Current Sense	DF13-5P-1.25V	Hirose
CN800	Power Supply Input	Power Jack 2.0 mm	e.g. Kycon
CN800#	Power Supply Input	Power Jack 4-pin	e.g. Nexus
CN801	Power Supply Input	Adapter bushing	---
CN802	Low-Power-PSU Input	Adapter bushing	---



16. Appendix A: Drawings

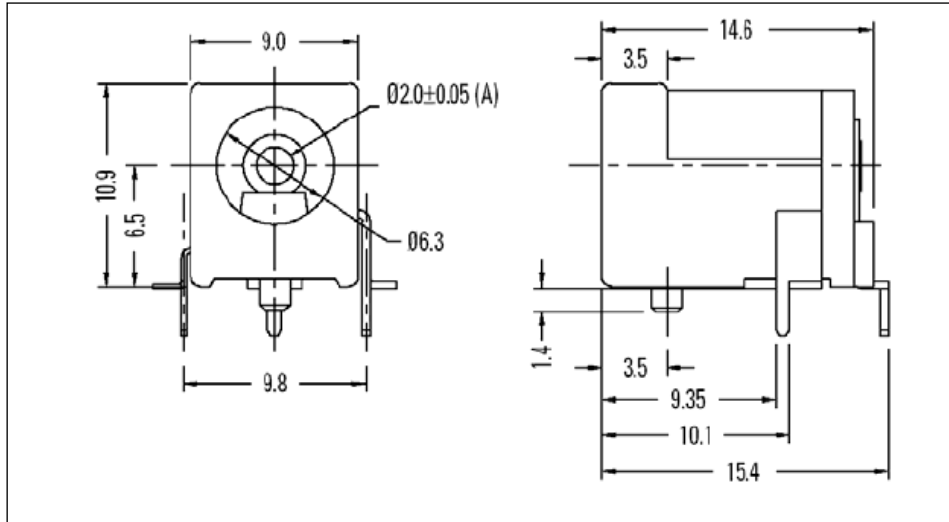

Optional Power Connector CN800

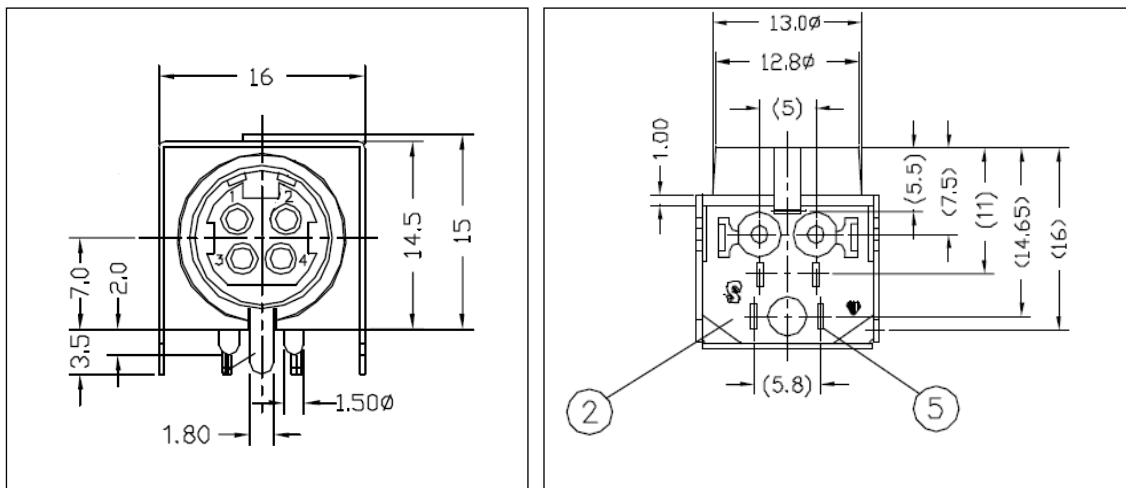

Default Power Connector CN800#

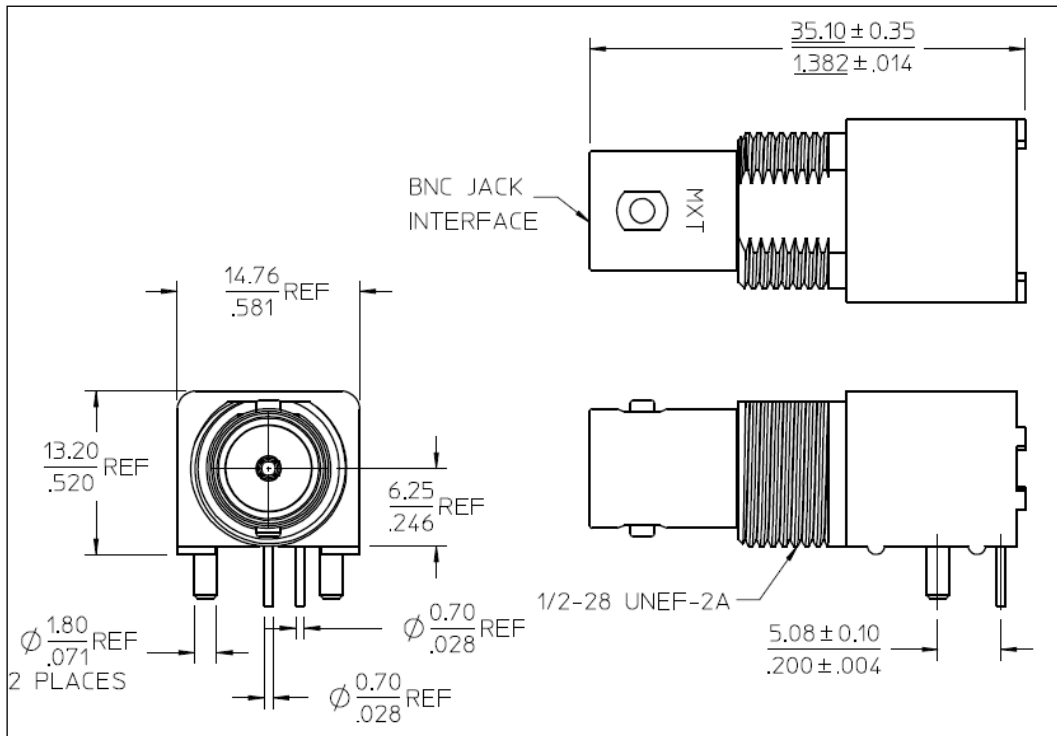

SDI Input Connector CN4

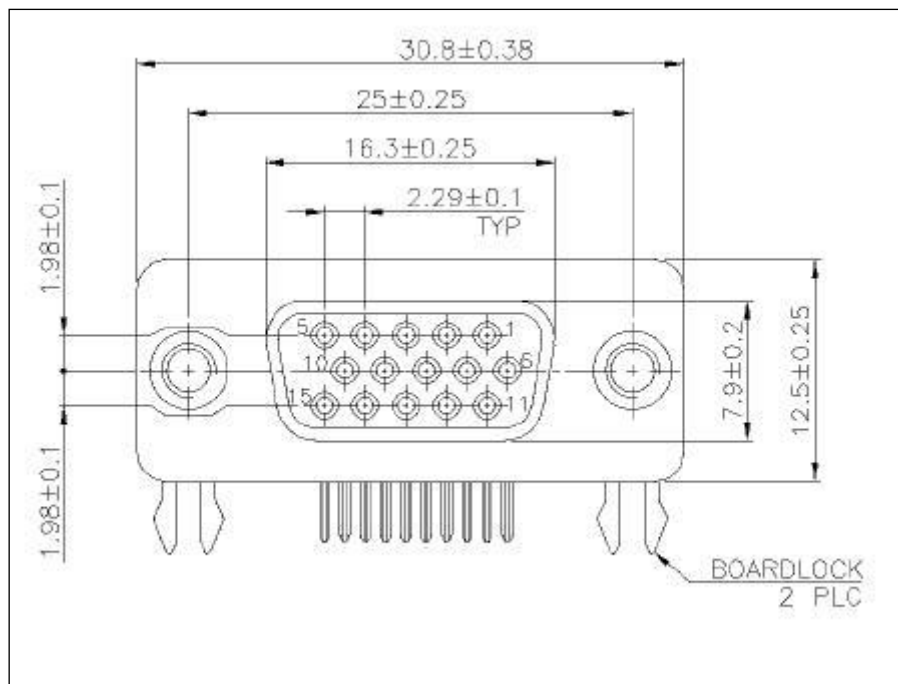

VGA Connector CN502

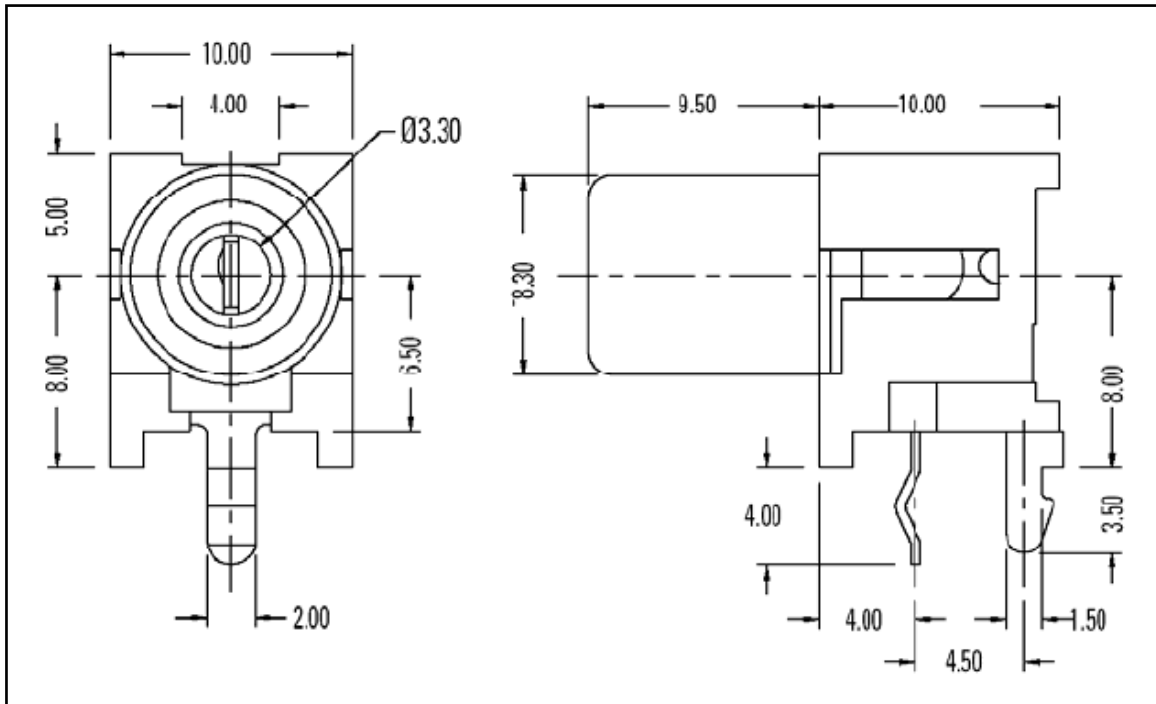

Audio L/R in and Coax S/PDIF-Audio Out Connectors CN15, CN16, CN503

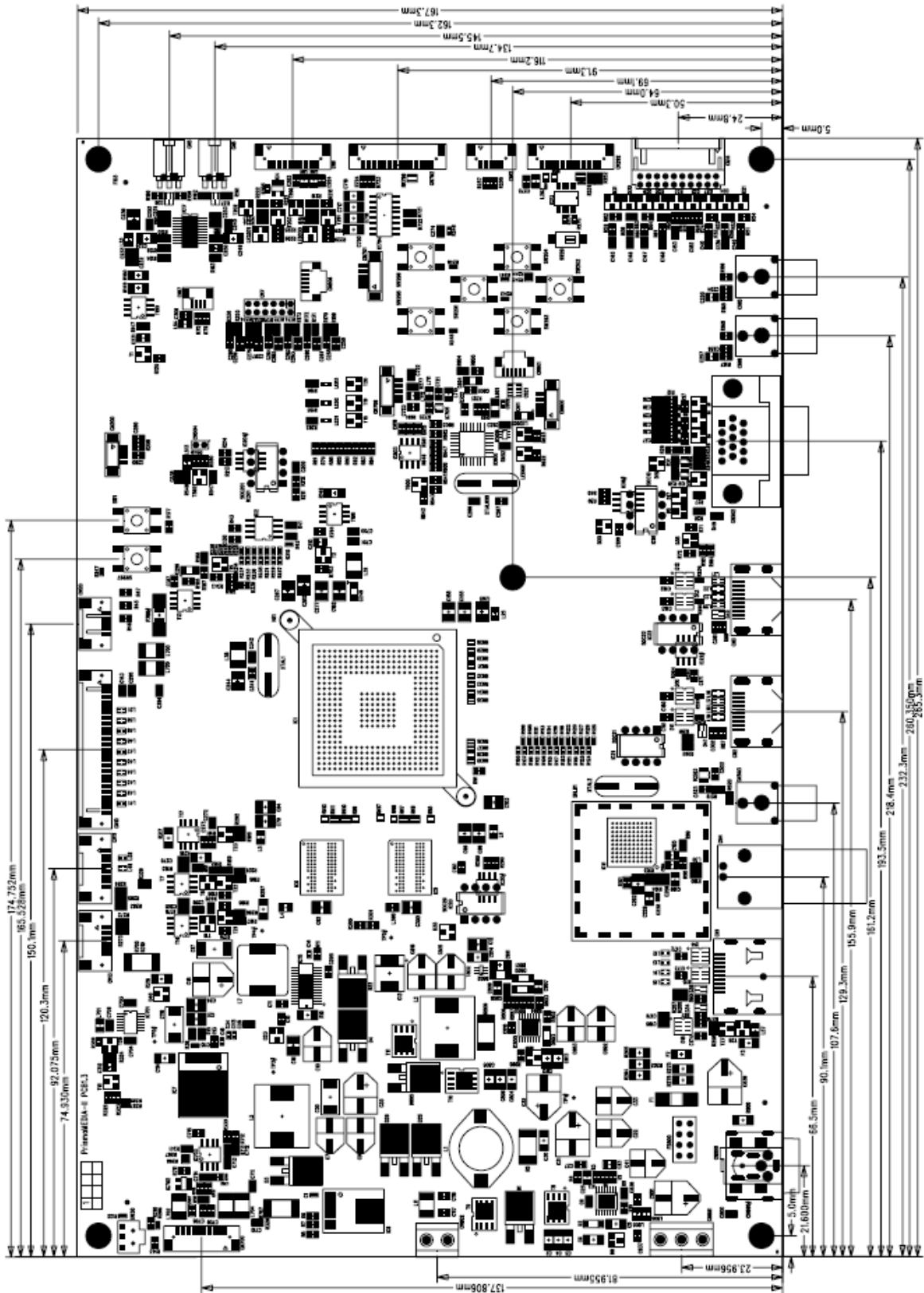



17. Appendix B: PSU

PSU low-power-control timings (CN202 pin-2)

The time between power-on/off to PSU signal state-change may differ between different kits, mainly for the power-off, since the system first goes through a panel-power-down sequence which is different for every kit. Following measurements have been taken with a Samsung LTM170EU-L21 panel with C&C GH053A inverter and are average values. Given values are for the power-on/off button. IR works ~40ms faster for the first step in each case.

Power on timings:

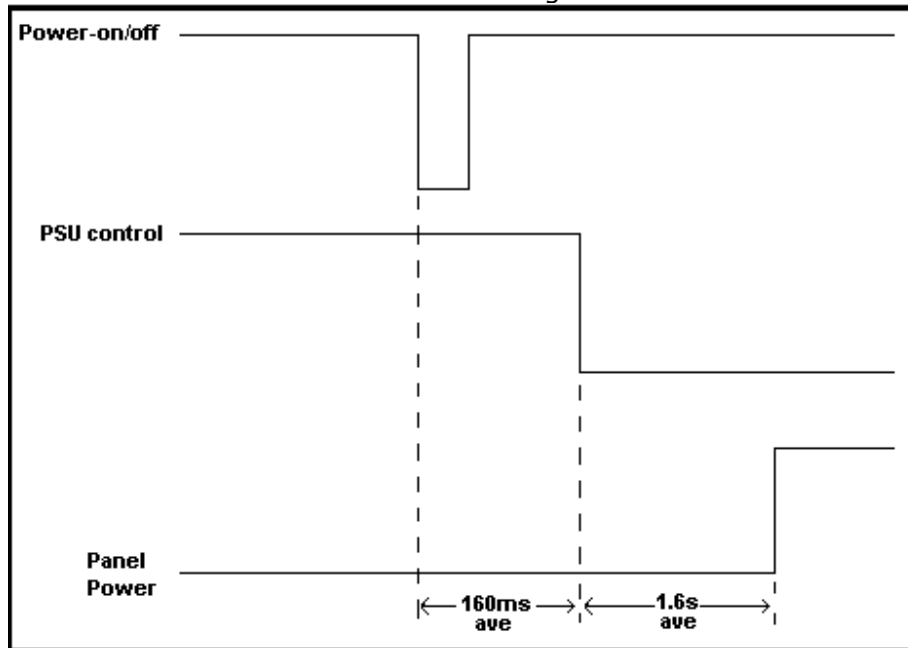

Power off timings:

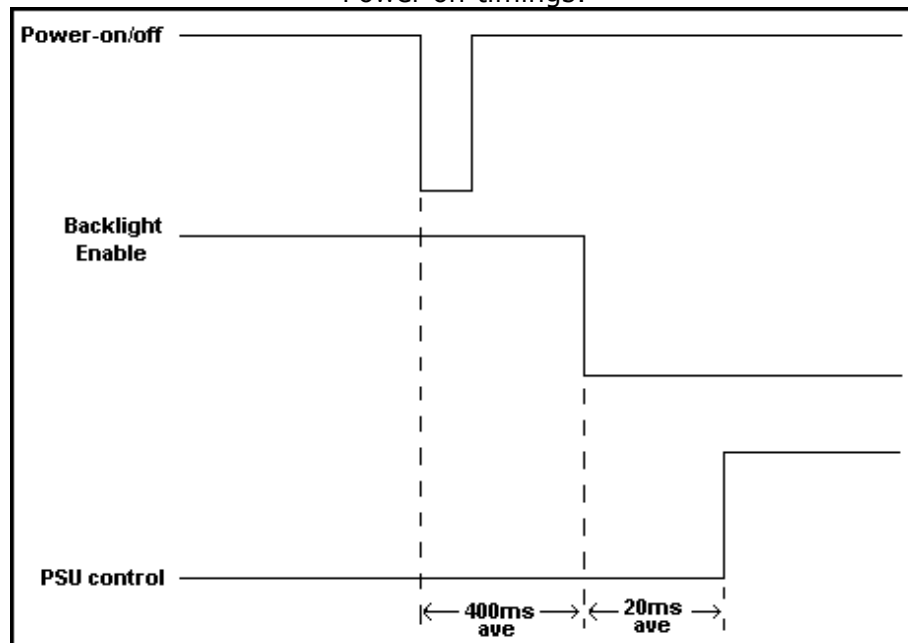

Our company network supports you worldwide with offices in Germany, Great Britain, Turkey and the USA.
For more information please contact:



DATA DISPLAY GROUP

A **FORTEC** GROUP MEMBER

Distec GmbH

Augsburger Str. 2b
82110 Germering
Germany

Phone: +49 (0)89 / 89 43 63-0
Fax: +49 (0)89 / 89 43 63-131
E-Mail: info@datadisplay-group.de
Internet: www.datadisplay-group.de

Display Technology Ltd.

5 The Oaks Business Village
Revenge Road, Lordswood
Chatham, Kent, ME5 8LF
United Kingdom
Phone: +44 (0)1634 / 67 27 55
Fax: +44 (0)1634 / 67 27 54
E-Mail: info@displaytechnology.co.uk
Internet: www.datadisplay-group.com

Sales Partner:

DATA DISPLAY BİLİŞİM TEKNOLOJİLERİ İÇ VE DIŞ TİCARET LİMİTED ŞİRKETİ

Barbaros Mh. Ak Zambak Sk. A Blok D:143
34376 Ataşehir / Istanbul
Turkey
Phone: +90 (0)216 / 688 04 68
Fax: +90 (0)216 / 688 04 69
E-Mail: info@data-display.com.tr
Internet: www.data-display.com.tr

FORTEC Elektronik AG

Lechwiesenstr. 9
86899 Landsberg am Lech
Germany

Phone: +49 (0)8191 / 911 72-0
Fax: +49 (0)8191 / 217 70
E-Mail: sales@fortecag.de
Internet: www.fortecag.de

Apollo Display Technologies, Corp.

87 Raynor Avenue,
Unit 1 Ronkonkoma,
NY 11779
United States of America
Phone: +1 631 / 580-43 60
Fax: +1 631 / 580-43 70
E-Mail: info@apolloDisplays.com
Internet: www.apolloDisplays.com