

# Datasheet

## PrismaMEDIA-Eco

### All-In-One RGB/ HDMI/DP Converter Board For VGA – WUXGA Panels

Standard Version

PR-01-211\* PrismaMediaECO-01-RHD\_00

Optional Version: (highlighted in red)

Including USB-B to UART & 2x5W Audio Amplifier & headphone audio jack

PR-01-210\* PrismaMediaECO-00-RHD\_AU



Version 1.4.8

**20.08.2018**

The information contained in this document has been carefully researched and is, to the best of our knowledge, accurate. However, we assume no liability for any product failures or damages, immediate or consequential, resulting from the use of the information provided herein. Our products are not intended for use in systems in which failures of product could result in personal injury. All trademarks mentioned herein are property of their respective owners. All specifications are subject to change without notice.

## Table of Contents

1	Revision History .....	4
2	Overview .....	6
2.1	General Features .....	6
2.2	Hardware Features .....	7
2.3	Hardware Information .....	8
3	Input / Output Interfaces.....	8
4	OSD Menu and User Controls .....	9
4.1	OSD Control Through External Keypad .....	9
4.1.1	4-Button OSD Keypad ZU-02-398.....	9
4.1.2	6- Button OSD Keypad ZU-02-378.....	10
4.1.3	Onboard Keys .....	10
4.2	OSD Control through IR Remote Control.....	11
4.3	OSD control through Remote OSD (ROSD).....	12
5	On-Screen-Menu .....	13
5.1	Image Menu .....	13
5.1.1	Color Sub-Menu .....	14
5.2	Display Menu .....	15
5.3	Sound Menu.....	16
5.4	System Menu .....	17
5.4.1	Input Sub-Menu .....	18
5.4.2	OSD Settings Sub-Menu .....	18
5.4.2.1	Timer: Selects how many seconds the OSD will remain active after the last use .....	19
5.4.2.2	Rotation: Rotates the OSD menu.....	19
5.4.2.3	Position: Manual adjustment of OSD placement .....	20
5.4.2.4	Transparency: Selects OSD blending with background .....	20
5.4.2.5	Remote Control - IR: .....	21
5.4.2.6	Keypad: Switch the OSD-Keypad from 6 to 4 button mode.....	22
5.4.3	Reset .....	22
5.4.4	EDID Write Protect (only in OSD Version 1.0.0).....	23
5.4.5	Auto Brightness.....	23
6	Supported Input Modes .....	24
6.1	VGA.....	24
6.2	HDMI – Graphics .....	24
6.3	HDMI – Video.....	24
6.4	DisplayPort .....	25
7	Audio Support .....	26
7.1	Audio Input.....	26

7.2 Audio Output .....	26
7.2.1 AC Characteristics .....	26
8 Absolute Maximum Ratings .....	27
9 Electrical Characteristics .....	27
10 Connector Overview .....	29
11 Input Connectors .....	30
12 Output Connectors .....	32
13 I/O Connector .....	34
14 Mechanical Drawing .....	35
15 Supported Panels and Backlights (Inverter/Converter) .....	36

## 1 Revision History

Date	Rev.No.	Description	Page
16.01.2012	1.0	Release of preliminary data sheet	
19.01.2012	1.1.0	Added features	
25.07.2012	1.1.1	Updated features (no 10-bit panel output) Changed USB type from A to B	4 16, 18
16.08.2012	1.2.0	General overhaul, OSD, electrical specs	
06.09.2012	1.2.1	Changed front page picture	1
28.09.2012	1.2.2	Status LED (keypad) update – green blink added for input search Updated OSD with new features (Headphone and EDID WP)	8 15, 16, 19
18.01.2013	1.2.3	Optional IR support	9
11.04.2013	1.2.4	OSD updated (IR and auto headphone detect)	12, 14, 16
03.09.2013	1.2.5	Changed front page picture and formation on all pages Added 4 button 6 button support Added ROSD description	1, all 6, 7, 19 12
15.10.2013	1.2.5	Explained RemoteOSD deeper	12
22.10.2013	1.2.6	Added Auto Brightness Configuration Added Transparency OSD	17, 22 20
04.11.2013	1.2.7	Added ChandlerRover hint Changed formation Added ZU-02-398	4 All 7
06.11.2013	1.2.8	Corrected IR-Remote description	11
28.01.2014	1.2.9	Added ordering info for IR sensor	9
26.03.2014	1.3.0	Corrected CN9 Pin Assignment	29
12.05.2014	1.3.1	Corrected 4-Button-OSD	7
14.05.2014	1.3.2	Reworked hole user control chapter	7-10
15.05.2014	1.3.3	Reworked Layout	All
28.07.2014	1.3.4	Added change of OSD – AutoBrightness Button	
28.01.2015	1.3.5	Typo removed	5
18.02.2015	1.3.6	Changed 4 Button navigation and added Brightness dialog	7
20.02.2015	1.3.7	Change Remote Control part number	9
22.04.2015	1.3.8	Resolution 1280 x 800 added in chapter 6.1, 6.2 and 6.4	22, 23
22.01.2016	1.4.0	Ordering Information added in chapter 2.2 Front Page adjusted CN20 description adjusted CN18 description added Maximal allowed power consumption added in chapter 9 Thermal Derating Characteristics added in chapter 9.3 Last page updated	6 1 29, 30 7, 28, 31 25 26 33
25.04.2016	1.4.1	Company logo updated HDMI version updated	All 6
19.07.2016	1.4.2	Added General Features	5
07.09.2016	1.4.3	Added Mechanical Dimensions	32
23.05.2017	1.4.4	Added DDC/CI support and Changed Lead-free to RoHS Changed Chapter Ordering Information to Hardware Information Added Ordering Information Status Changed 4-Button OSD Keypad Picture Added RS232 connection picture Changed Chapter 14 to Chapter 10 Added Weight Removed Chapter 15 "News and Updates" Added Chapter 15 Supported Panels and Backlights	5 7 7 8 11 27 32 33 34
05.07.2017	1.4.5	USB interface description added	6

---

11.08.2017	1.4.6	Changed Part Number PR-01-211_A1 to Obsolete Added[12V] (VDISP) Panel power Corrected Board Width: 100mm Last page updated	8 26 34 36
30.11.2017	1.4.7	Corrected name of option pin 0; added DP HW requirements	25, 34
20.08.2018	1.4.8	VGA_PLUG and HDMI_PLUG pins updated	30

## 2 Overview

The PrismaMEDIA-Eco is a powerful graphics processing board, providing high-quality images for TFT panels. This converter supports 6/8-bit LVDS panels up to WUXGA (1920 x 1200) and can be used in a variety of systems.

### 2.1 General Features

- Zoom and shrink scaling
- Faroudja Real Color processing
- Supports VESA DDC/CI and a subset of VESA DPMS standards
- PWM or voltage controlled backlight intensity
- 12V main power input
- Six-button external OSD - keypad interface and on-screen menus allow adjustments to the system
- True High Definition 1080p on HDMI 1.4 input
- Display Port 1.1a input up to 2560x1600 @ 60Hz
- Analog RGB/VGA input captures 1920 x 1200 @ 60Hz
- USB (or serial) remote control capability (Remote OSD via PC)
- RoHS
- DDC-Control on VGA, HDMI and Display Port
- Auto Brightness regulation in combination with a ambient light sensor
- 15.75 to 68KHz Legacy Timings
- Analog RGB Sync On Green Capable
- RS170 and RS343 Video Input Option (progressive mode only, framerate limited to panel framerate)
- Fully Customizable through the configuration software "ChandlerRover"

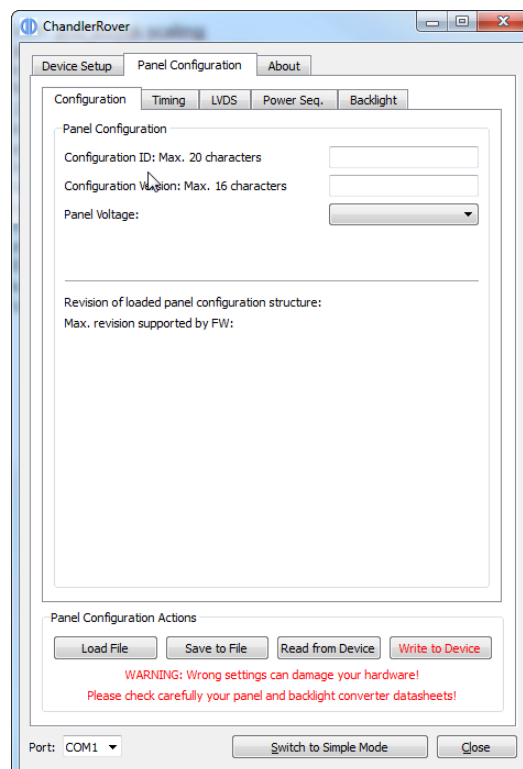

## 2.2 Hardware Features

### Analog RGB Input

- Supports up to 1792x1344@60Hz or 1920x1260@60Hz or 1600x1200@75Hz standard modes
- Supports up to 1920x1440@60Hz or 2128x1200@ 60Hz with reduced blanking
- Captures up to 205MHz

### Ultra-Reliable HDMI 1.4 Receiver

- Single Link TMDS Rx for up to 12-bit 1080p
- Captures up to 225MHz
- Direct connect to all HDMI compliant TMDS transmitters
- HDCP support

### DisplayPort Receiver

- 10.8Gbps total bandwidth over 4 lanes
- 2560x1600@60Hz input support at 12-bit
- HDCP support

### LVDS Interface

- Fully programmable LVDS mappings for compliance with all LVDS protocols

### Auto-Configuration / Auto-Detection

- Phase and image positioning
- Input format detection

### On Screen Display

- Horizontal and vertical stretch of OSD images
- 16 levels of blending

### Output Format

- Single/double wide LVDS up to WUXGA 60Hz output
- Support for 8 or 6-bit panels (with high-quality dithering)

### Audio Output

- 5W/Ch (8 $\Omega$ ) audio output (L/R) for HDMI/DP embedded audio
- USB 2.0 Full Speed compatible.

### USB Interface

- USB 2.0 Full Speed compatible

## 2.3 Hardware Information

Part Number	USB	Audio	Additional LVDS Power Connector (CN20)	Operating Temperature Range	Status
PR-01-210	X	X	O	0..+70°C	Obsolete
PR-01-211	O	O	O	0..+70°C	Obsolete
PR-01-210_A2	X	X	X	0..+70°C	Obsolete
PR-01-211_A1	O	O	X	0..+70°C	Obsolete
PR-01-210_A3	X	X	X	-20..+80°C	Active
PR-01-211_A2	O	O	X	-20..+80°C	Active

X = Available, O = Not available

## 3 Input / Output Interfaces

The following drawing shows the input and output interfaces of the PRISMAMEDIA-ECO. The design is implemented as a single printed circuit board.

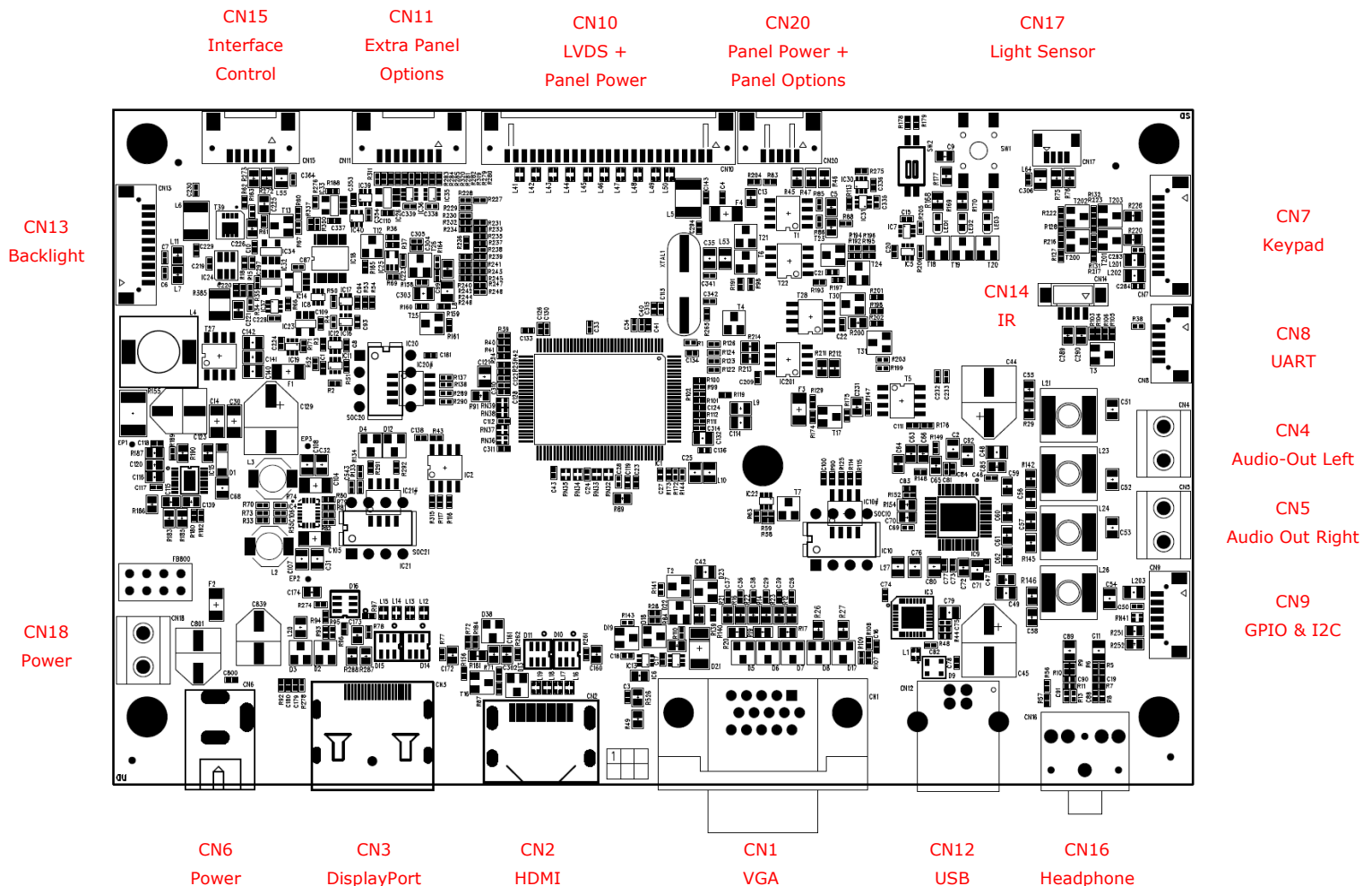



## 4 OSD Menu and User Controls

The OSD allows selection of input source and fine tuning of various functional parameters like brightness, contrast etc. These parameters can be adjusted via an external interface.

### 4.1 OSD Control Through External Keypad

An OSD-Keypad can be used to control the OSD. There is a 4-Button and 6-Button OSD Keypad available.

It depends on the factory settings of the firmware, which keypad is active.

The 4/6-Button Keypad can be selected in the submenu: OSD Settings -> Keypad Layout

#### 4.1.1 4-Button OSD Keypad ZU-02-398

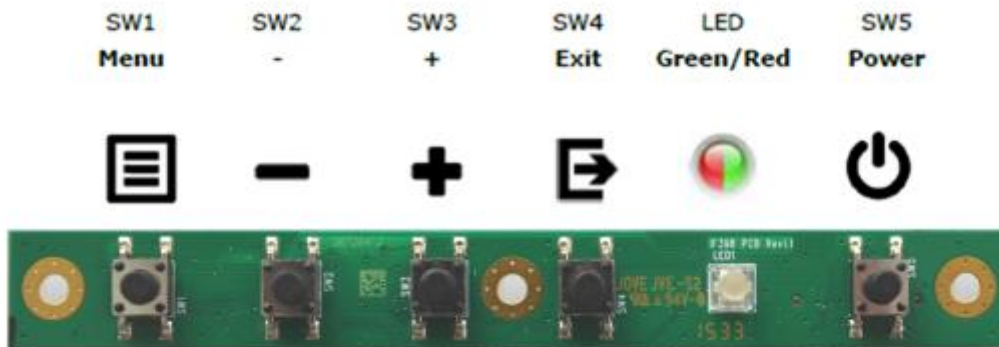

The following tables give you an overview about the functionality.

	Menu	-	+	Exit	LED	Power
General					See below	Power ON/OFF
OSD closed	Open OSD	Volume*	Brightness	Input Select		
OSD open	Select	Down/Left/-	Up/Right/+	Exit/Back		

\*Volume dialog is only accessible on PrismaMEDIA-Eco boards with audio outputs or when input is not RGB.

LED Status:

- Green : Signal Found
- Green flashing : Searching Signal
- Red : Power Safe
- LED OFF : Power OFF
- Red flashing : No Panel Configuration is flashed

### 4.1.2 6- Button OSD Keypad ZU-02-378

For users that wish to use a 6-button OSD, a keypad with 6 OSD control buttons is available.

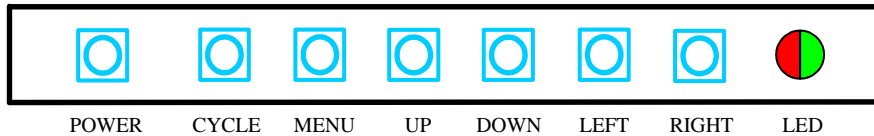
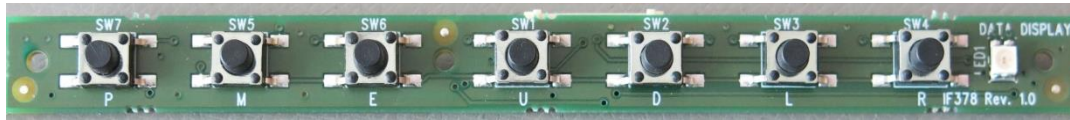

The following tables give you an overview about the functionality.

	Power	Cycle	Menu	Up	Down	Left	Right	LED
<b>General</b>	Power ON/OFF							See below
<b>OSD closed</b>		Input Select	Open OSD	Brightness	Volume*	Decrease brightness	Increase brightness	
<b>OSD open</b>		Select	Exit/Back	Up/+	Down/-	Left/-	Right/+	

\*Volume dialog is only accessible on PrismaMEDIA-Eco boards with audio outputs or when input is not RGB.

LED Status:

- Green : Signal Found
- Green flashing : Searching Signal
- Red : Power Safe
- LED OFF : Power OFF
- Red flashing : No Panel Configuration is flashed

### 4.1.3 Onboard Keys

There is one on-board key on the PrismaMEDIA-Eco, which is the reset key:

Key	Function
RESET	Reset PrismaMEDIA-Eco to the last saved state

This key performs similarly with a main power plug out and back in, and is mostly for R&D purposes.

## 4.2 OSD Control through IR Remote Control



Alternative to the external keypads, the PrismaMedia-ECO can also be controlled through a remote control device.

In order to communicate through IR, an IR-receiver **ZU-02-406** can be attached to the PrismaMedia-ECO. Then you can control the PrismaMedia-ECO with the IR Remote Control **RC-10-005** (see picture below).



### Remote controller functionality:

Rubber key marking	Chase marking	hex code	Functions
	Power	0x01	Power on/off board
	PAP	0x0B	
	Mute	0x05	
	Volume	0x04	Increase volume while OSD is closed
		0x03	Decrease volume while OSD is closed
	Brightness	0x30	Increases brightness while OSD is closed
		0x31	Decreases brightness while OSD is closed
		0x0D	Moves up through possible selections, Switch main input port while OSD is closed
		0x11	Moves down through possible selections, Switch pip input port while OSD is closed
		0x0E	Exits current sub-menu / function (goes to upper menu), Moves left through possible selections or slider, Decrease brightness while OSD is closed

		0x10	Enters current sub-menu / function, Moves right through possible selections or slider, Increase brightness while OSD is closed
		0x0F	Enters chosen function
M	Source	0x23	
P	Source	0x24	
blank	Menu	0x27	Opens OSD
blank	Exit	0x13	Closes OSD
blank	Freeze	0x1A	Freeze image
blank	Auto	0x21	Auto-configuration for VGA input
blank	Aspect Main	0x17	Changes Aspect in Main View

### 4.3 OSD control through Remote OSD (ROSD)

The PrismaMEDIA-Eco can be controlled with the ROSD Protocol (Remote OSD) via PC, which is a proprietary Data Display Group protocol.

You can use your COM port to communicate with the serial port of the Board which is CN8. You may need an interface board IF370 / ZU-02-370 with cable KA-30-101 to configure the board with the Data Display ChandlerRover software or to control the board via Remote OSD.

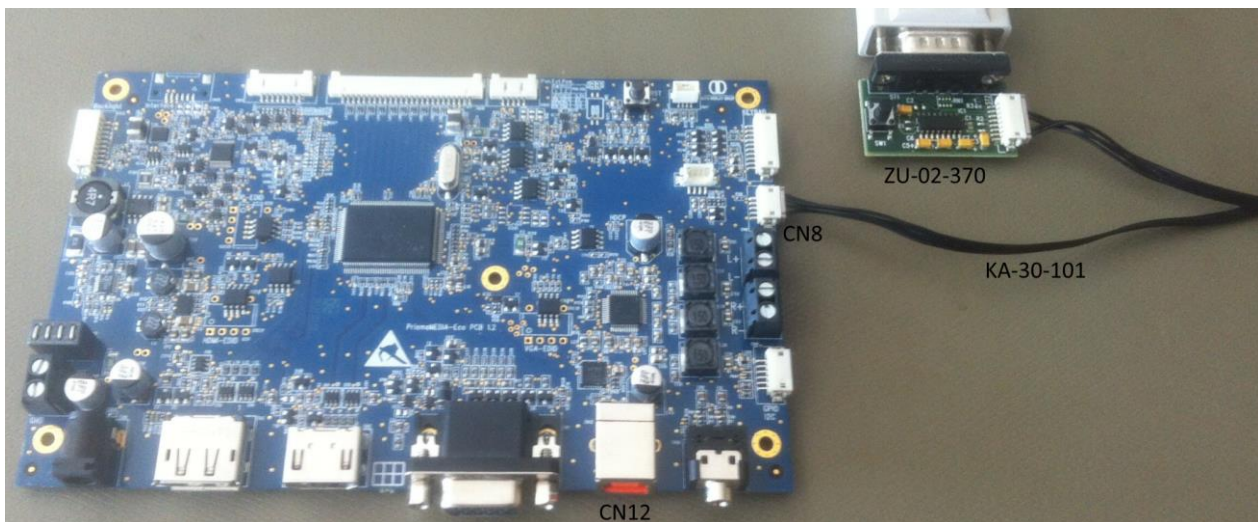

If you purchase a PR-01-210\_A2 which also has an USB to serial converter on the board, you may control your board's OSD over the USB too. It will appear in the Device Manager as a new COM port, when you connect through USB connector CN12. Then you should use this COM port for all the communication with your PrismaMEDIA-Eco board.

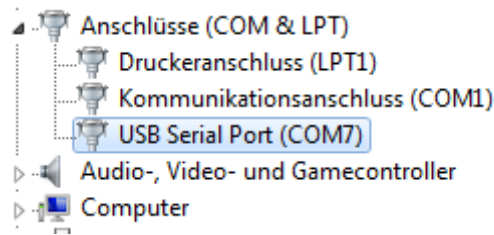

The ROSD protocol is explained in a separate document. Please contact sales for further information.

## 5 On-Screen-Menu

### 5.1 Image Menu

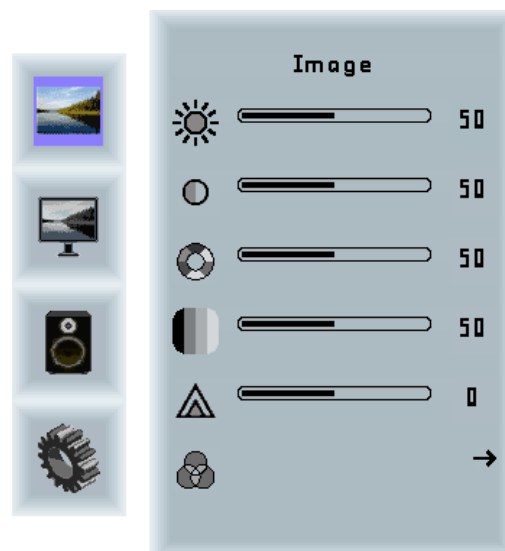

**Brightness:** Brightness of the image can be controlled using this function, with left and right buttons after the brightness slider is selected. This function modifies RGB data to change the brightness.

**Contrast:** Allows <Contrast> adjustment in the Y domain. The modification affects all color channels and all input types and is a direct multiplication of the Y data after YUV black level adjustment.

**Hue:** Allows <Hue> adjustment in the UV domain. The modification affects all color channels and all input types. Available if color space of input is not RGB.

**Saturation:** Allows <Saturation> adjustment in the UV domain. The modification affects all color channels and all input types. Available if color space of input is not RGB.

**Sharpness:** Allows <Sharpness> adjustment on the image.

**Color:** Opens the color sub-menu.

## 5.1.1 Color Sub-Menu



**Auto:** ADC-Calibration. It performs auto-color adjustment.

**Full color:** Selects full received color space.

**srgb:** Selects srgb color space.

**xycc:** Selects xycc color space.

**Color Temp:** Allow selection of different color temperature schemes, predefined and custom. Available if color space of input is RGB.



## 5.2 Display Menu

Available if source is VGA input.

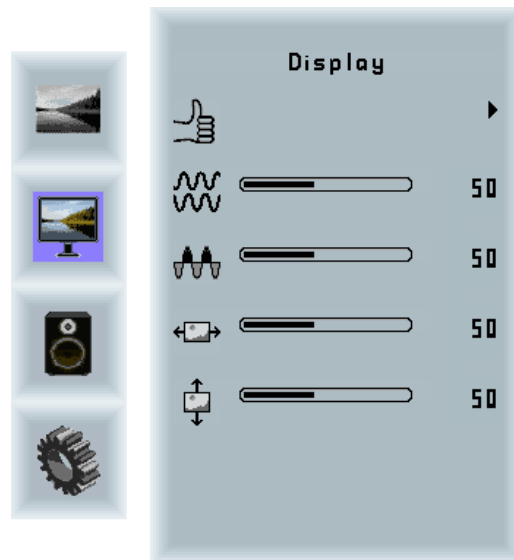

**Auto-adjust:** Performs auto-adjustment on the VGA input image.

**Phase:** This function is a slider to adjust the sampling phase of the analog interface. For optimum image quality, input pixels should be sampled at the ideal sampling points.

**Clock:** This function is a slider to adjust the sample clock of the analog interface. This is helpful for improving the image quality for non-standard display modes.

**Display position:** Used to alter placement of the image.

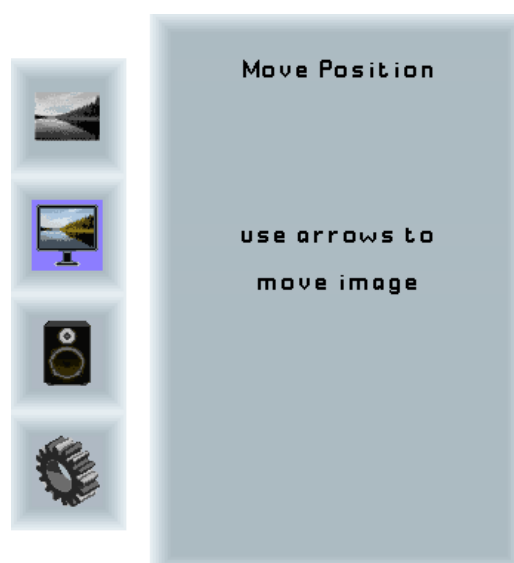

### 5.3 Sound Menu

Available only if input type is HDMI or DisplayPort and PrismaMEDIA-Eco has Audio outputs (**PR-01-210 only**).

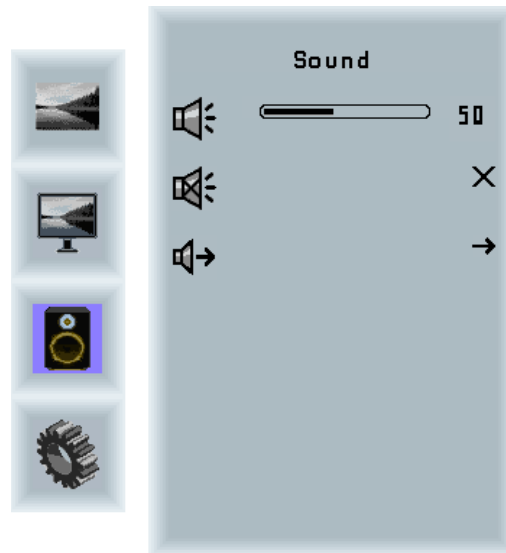

**Volume:** Slider bar to adjust volume

**Mute:** Mutes audio

**Output:** Chooses between automatic headphone detection, speakers and headphone. Default is auto-detection. Speakers and headphone cannot be active together.

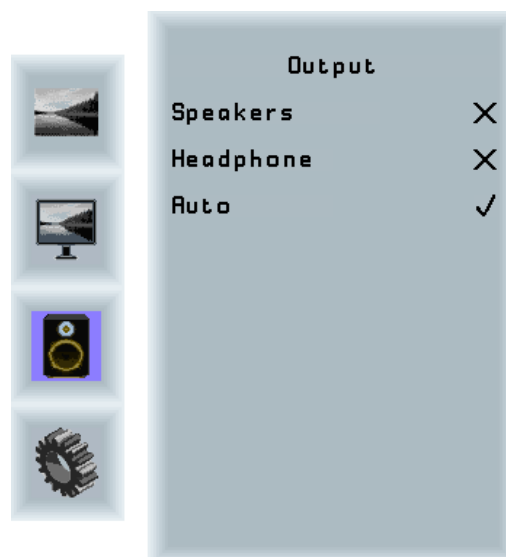



## 5.4 System Menu

Contains the following sub-menus:

Inputs, OSD settings, factory reset, EDID write protect, Auto Brightness and FW/OSD revision information.



If there is no Auto Brightness sensor is available, Auto Brightness icon is either not shown or non-selectable according to the firmware version.

Firmware Version	Sensor Available	Sensor Not Available
< 3.0.0	Auto brightness is not available	
< 3.2.0	Icon Shown	Icon Shown, but not selectable
>= 3.2.0	Icon Shown	Icon not shown

### 5.4.1 Input Sub-Menu

- Manual selection of input
- Enable/disable input auto-scan



### 5.4.2 OSD Settings Sub-Menu

Contains timer, rotation, position adjustment, transparency, IR enable and Keypad switch

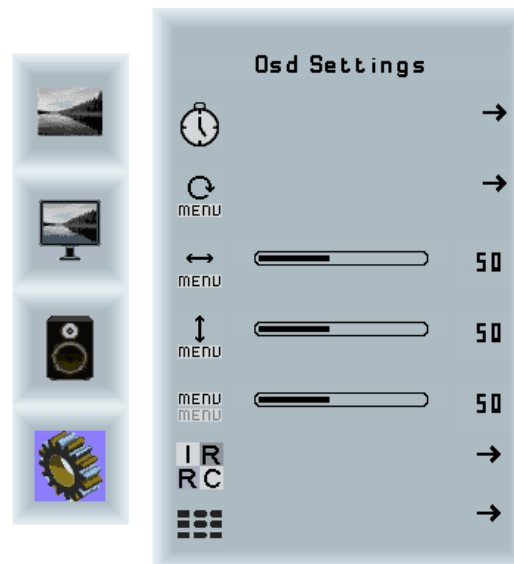

### 5.4.2.1 Timer: Selects how many seconds the OSD will remain active after the last use



### 5.4.2.2 Rotation: Rotates the OSD menu

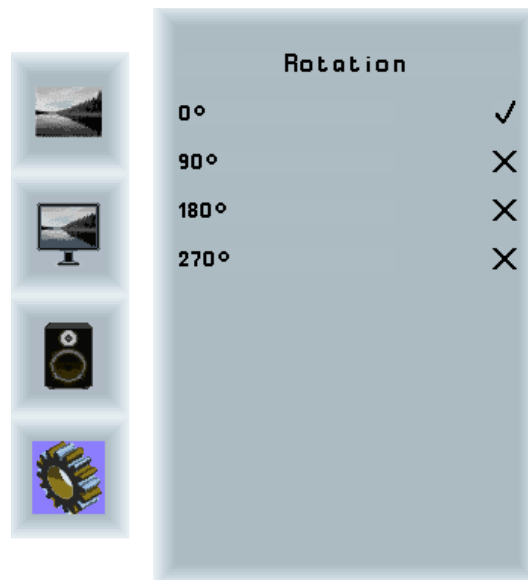

**5.4.2.3 Position: Manual adjustment of OSD placement**



**5.4.2.4 Transparency: Selects OSD blending with background**



### 5.4.2.5 Remote Control - IR:

The remote control - IR function enables or disables the remote control interface. If current state is on, after selecting the off state, the osd interface requests the user to press right, left, right, left keys in sequence. This is done to prevent accidental de-activation of the IR interface, as a user which has no external keypad and no serial port communication will have no means to turn IR back on.

Remote control through infrared function is shared with DisplayPort powered source detection. Enabling infrared will convert DisplayPort cable-detect from powered up source detection to simple cable ground plug detection. The former method is preferred due to elimination of cable plug wake ups when source is not powered on, but since the board will go back to sleep mode, it is not critical.



**5.4.2.6 Keypad: Switch the OSD-Keypad from 6 to 4 button mode**



**5.4.3 Reset**

**Reset:** Performs a factory reset and returns all settings to default values.



#### 5.4.4 EDID Write Protect (only in OSD Version 1.0.0)

**EDID Write Protect:** Toggles EDID write protect on or off.



#### 5.4.5 Auto Brightness

**Auto Brightness:** Toggles the Auto Brightness regulation of the Ambient Light Sensor on or off



## 6 Supported Input Modes

The PrismaMEDIA-Eco can support the following input modes.

### 6.1 VGA

The PrismaMEDIA-Eco is equipped with one VGA connector CN1.  
The factory preset supported input modes include:

Resolution	Resolution
640 x 480 @ 60 Hz (VESA)	1360 x 768 @ 60 Hz
800 x 600 @ 60 Hz (VESA)	1366 x 768 @ 60 Hz
1024 x 768 @ 60 Hz (VESA)	1368 x 768 @ 60 Hz
1280 x 768 @ 60 Hz	1600 x 1200 @ 60 Hz (VESA)
1280 x 800 @ 60 Hz	1920 x 1200 @ 60 Hz
1280 x 1024 @ 60 Hz (VESA)	1920 x 1080 @ 60 Hz

### 6.2 HDMI – Graphics

The PrismaMEDIA-Eco is equipped with the HDMI connector, CN2.  
The factory preset supported input modes include:

#

Resolution	Resolution
640 x 480 @ 60 Hz (VESA)	1360 x 768 @ 60 Hz
800 x 600 @ 60 Hz (VESA)	1366 x 768 @ 60 Hz
1024 x 768 @ 60 Hz (VESA)	1368 x 768 @ 60 Hz
1280 x 768 @ 60 Hz	1600 x 1200 @ 60 Hz (VESA)
1280 x 800 @ 60 Hz	1920 x 1200 @ 60 Hz
1280 x 1024 @ 60 Hz (VESA)	1920 x 1080 @ 60 Hz

### 6.3 HDMI – Video

The factory preset supported input modes include:

Resolution	Resolution
720 x 480 @ 60	1280 x 720 @ 60
720 x 576 @ 50	1920 x 1080 @ 50
1280 x 720 @ 50	1920 x 1080 @ 60



## 6.4 DisplayPort

The PrismaMEDIA-Eco is equipped with one DP connector, CN3.  
The factory preset supported input modes include:

Resolution	Resolution
640 x 480 @ 60 Hz (VESA)	1360 x 768 @ 60 Hz
800 x 600 @ 60 Hz (VESA)	1366 x 768 @ 60 Hz
1024 x 768 @ 60 Hz (VESA)	1368 x 768 @ 60 Hz
1280 x 768 @ 60 Hz	1600 x 1200 @ 60 Hz (VESA)
1280 x 800 @ 60 Hz	1920 x 1200 @ 60 Hz
1280 x 1024 @ 60 Hz (VESA)	1920 x 1080 @ 60 Hz

Note that PrismaMEDIA-Eco is performing Source Detection according to DisplayPort 1.1a specification. If your source is not detected by PrismaMEDIA-Eco, please check if the pull-up and pull-down requirements for the AUX-channel are fulfilled:

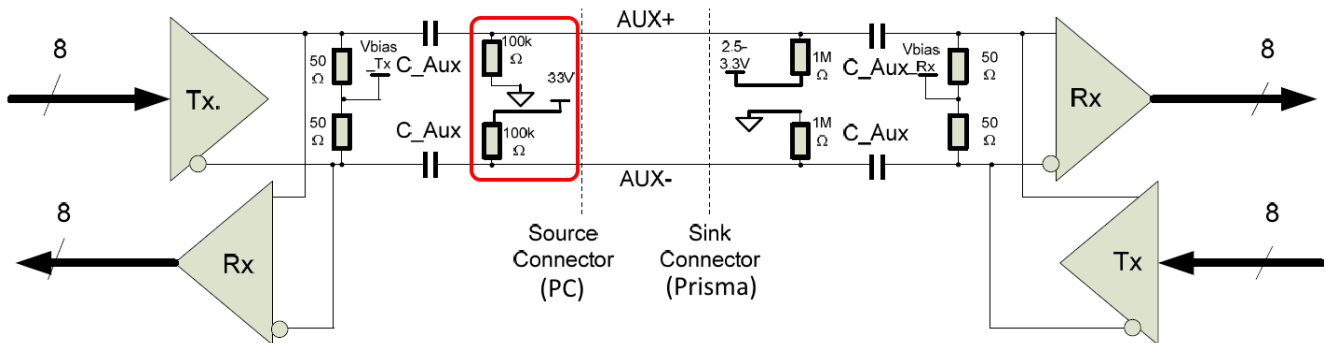

*The DisplayPort Source Device must weakly pull down the AUX+ line and weakly pull up the AUX- line with 100kΩ (+/-5%) resistors between the AC-coupling capacitor and the Source Connector to assist detection of DisplayPort Source and Powered DisplayPort Source by the Sink Device.*

*(VESA DisplayPort Standard, Version 1, Revision 1a, January 11, 2008, chapter 3.4)*

## 7 Audio Support

### 7.1 Audio Input

Digital Inputs (embedded into the interfaces)

- DisplayPort (DP)
- HDMI

### 7.2 Audio Output

- 2x5W@8ohm analog output via CN4 / CN5 (measured with 0dBFS level 1kHz sine wave)
- (Optional) Audio output gain level can be increased on customer request
- Headphone output (CN16)

#### 7.2.1 AC Characteristics

Item	Min.	Typ.	Max.	Unit	Note
THD+ N Total harmonic distortion + noise at PO = 1 W		0.2		%	
Channel equality		1		dB	
Crosstalk at PO = 0.25 W, f = 1 kHz		-82		dB	
SNR Signal-to-noise ratio at PO = 5 W, f = 1 kHz		-105		dB	

## 8 Absolute Maximum Ratings

Item	Symbol	Min.	Max.	Unit	Note
Supply Voltage	$V_{in(12V)}$	0	14	VDC	1, 2, 3, 4
Storage Temperature	$T_{St}$	-35	+85	°C	
Operating Temperature	$T_{Op}$	-20	+80	°C	5

**Note (1)** Within operating temperature range.

**Note (2)** Supply voltage limits are for the PrismaMEDIA-Eco, panel/inverter supply limits must be met as well, if the panel is +12V and the inverter is to be powered through the PrismaMEDIA-Eco board.

**Note (3)** Permanent damage to the device may occur if maximum values are exceeded.

**Note (4)** Supply voltage limits are for the PrismaMEDIA-Eco; inverter supply limits must be met as well, if the inverter is to be powered through the PrismaMEDIA-Eco board.

**Note (5)** See the derating characteristics below.

## 9 Electrical Characteristics

Remark: All values are average values of repeated measurements. Other PrismaMEDIA-Eco types or PrismaMEDIA-Eco/panel combinations can have different electrical characteristics.

All measurements done at 25°C ambient temperature.

Item	Condition	MIN.	TYP.	MAX.	Unit	Note
Supply Voltage		11.7	12.0	12.3	VDC	1
Current Consumption (12V)	Power-OFF	-	41	43	mA	
	Sleep mode	-	51	53	mA	
	Board only	-	158	165	mA	2
(Samsung LTM170EU-L31 with GH053A inverter)	SXGA, Moire-Y, 100% BRT	-	2.45	2.55	A	

### 9.1 Maximal allowed power consumption for TFT Panels (V<sub>DISP</sub>)

Item	Symbol	Max.	Unit	Note
<b>3.3V, (5V), [12V]</b> (V <sub>DISP</sub> ) Panel power	I <sub>DISP</sub>	1.3, (1.5), [2]	A	3), 4), 5)

## 9.2 Maximal allowed power consumption for backlight inverter (VBKL)

Item	Symbol	Max.	Unit	Note
+5V Backlight power on CON13	$I_{BKL}$			NA.
+12V Backlight power on CON13	$I_{BKL}$	3.0	A	5)

## 9.3 Thermal Derating Characteristics

The following graph shows the external power consumption vs. temperature characteristics of the PrismaMEDIA-Eco. The detailed limits for each output are described above.

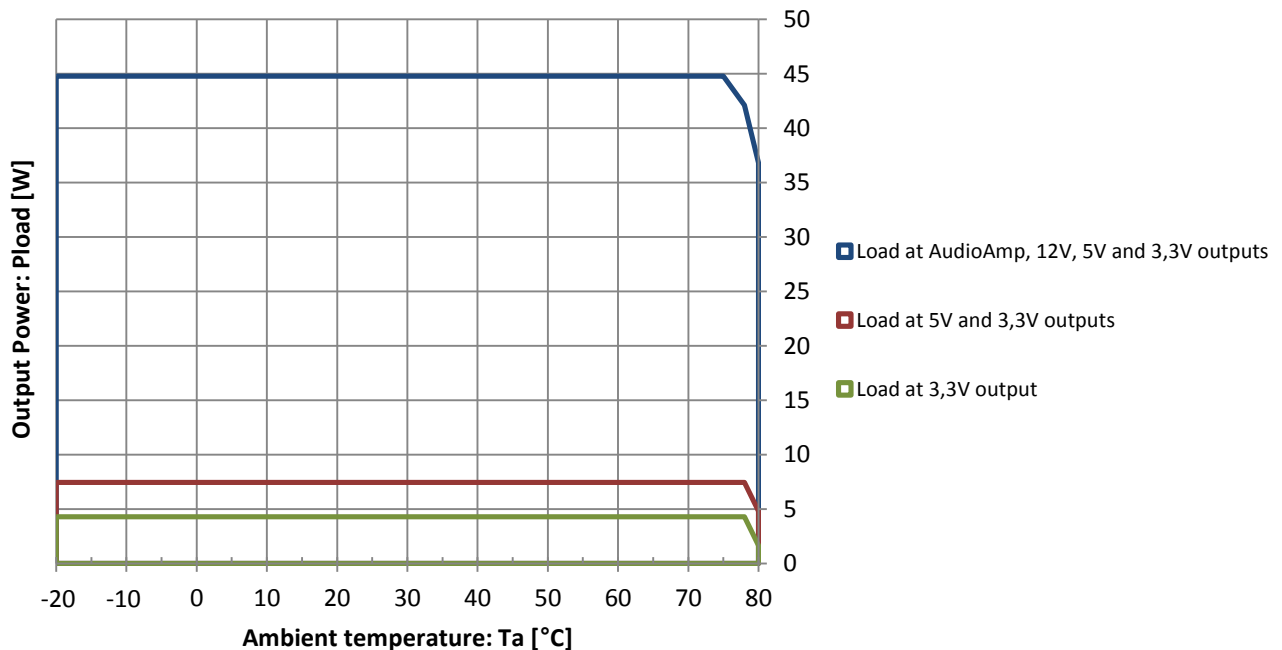

- Note (1)** Supply voltage limits are for the PrismaMEDIA-Eco, inverter supply limits must be met as well, if the inverter is to be powered through the PrismaMEDIA-Eco board.
- Note (2)** Changes with input type. Typical measurement is with VGA input (ADC active), digital inputs have ~6-8mA lower values.
- Note (3)** The maximum load at 3.3V for the ambient temperature range up to 70°C must not exceed 4.3W.
- Note (4)** The maximum total load at 5V and 3.3V for the ambient temperature range up to 70°C must not exceed 7.5W.
- Note (5)** The maximum total load at 12V, 5V and 3.3V for the ambient temperature range up to 70°C must not exceed 45W.

## 10 Connector Overview

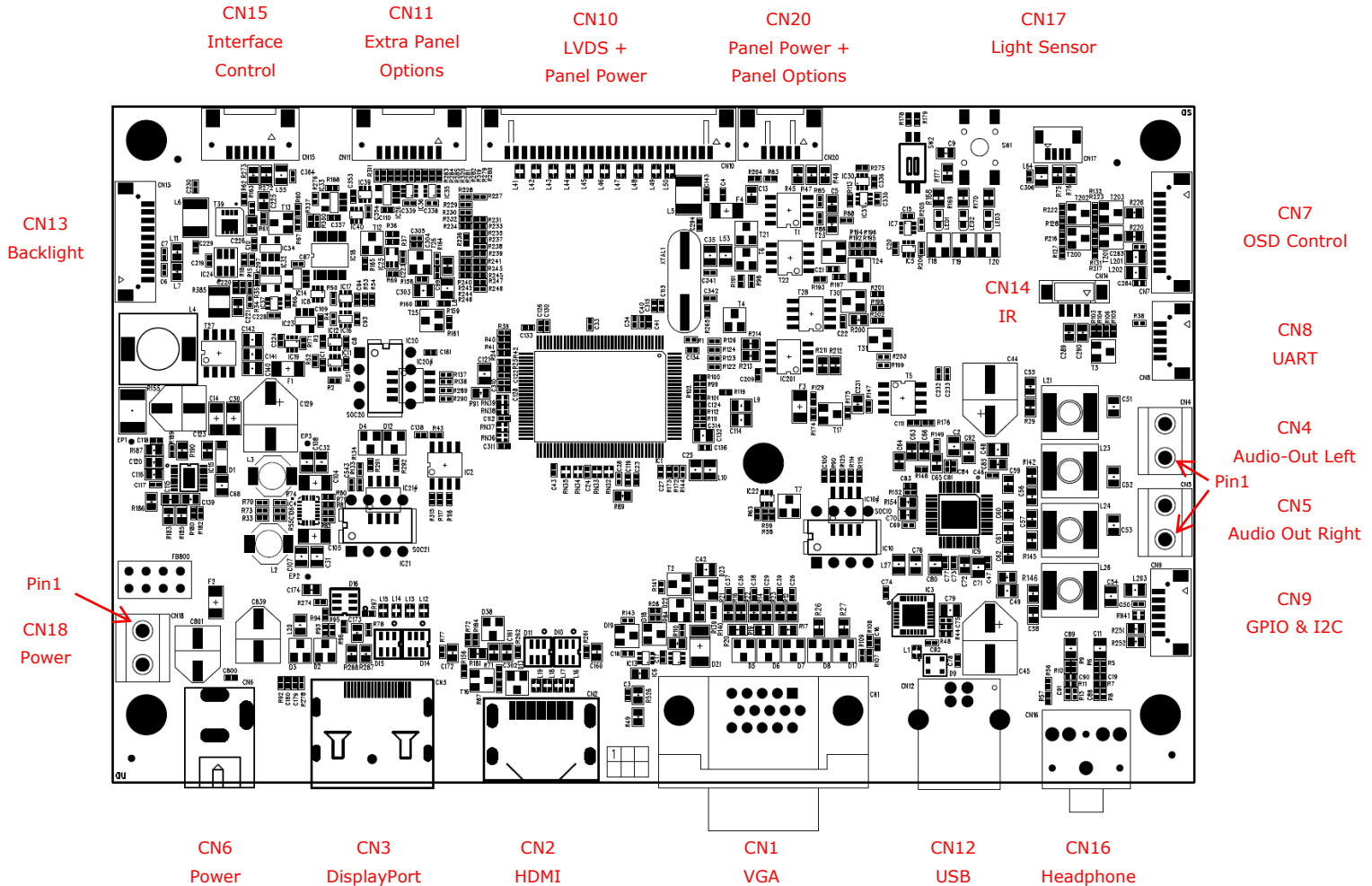

CN	DESCRIPTION	TYPE	MANUFACTURER
CN1	VGA Input	15-pin H-DSUB female	Zhenqin
CN2	HDMI Input	47151-1001	Molex
CN3	DisplayPort Input	47272-0001	Molex
CN4	Speaker left out <b>(OPTIONAL)</b>	Screw terminal block, 5mm, 2 pins	PTR
CN5	Speaker right out <b>(OPTIONAL)</b>	Screw terminal block, 5mm, 2 pins	PTR
CN6	DC Power Jack (5A)	PJ-002AH	CUI Incorporated
CN7	OSD Control	DF13-10P-1.25H	Hirose
CN8	UART/GProbe	DF13-5P-1.25V	Hirose
CN9	External GPIO/I2C	DF13-6P-1.25H	Hirose
CN10	Dual LVDS	DF14-25P-1.25H	Hirose
CN11	Ext. Panel Options (optional)	DF14-8P-1.25H	Hirose
CN12	USB Type-B <b>(OPTIONAL)</b>	USB-R-B-S-F-O-TH-R	Samtec

CN13	Backlight Power Supply	DF13-10P-1.25H	Hirose
CN14	Infrared <b>(OPTIONAL)</b>	DF13-4P-1.25V-21	Hirose
CN15	Interface Control <b>(OPTIONAL)</b>	DF14-6P-1.25H	Hirose
CN16	Headphone <b>(OPTIONAL)</b>	STX-3200-5NB	Kycon
CN17	Light Sensor <b>(OPTIONAL)</b>	501331-0407	Molex
CN18	Power Supply Input	Screw Terminal (5mm)	
CN20	Additional LVDS power <b>(Only from PR-02-211_A1, PR-01-210_A2 available)</b>	DF14-5P-1.25H	Hirose

## 11 Input Connectors

### RGB – ANALOG INPUT CONNECTOR CN1

Pin	Signal	Description
1	RED	Analog Red
2	GREEN	Analog Green
3	BLUE	Analog Blue
4	NC	Not connected
5	VGA_PLUG	Connect it to GND for cable detection
6	GND	Ground
7	GND	Ground
8	GND	Ground

Pin	Signal	Description
9	VGA_5V	Fused VCC
10	GND	Ground
11	NC	Not Connect
12	VGA_SDA	DDC Data
13	HSYNC	Horizontal Sync Input
14	VSYNC	Vertical Sync Input
15	VGA_SCL	DDC Clock

### HDMI CONNECTOR CN2

Pin	Signal	Description
1	TMDS2+	Differential TMDS Data 2+
2	GND	Ground
3	TMDS2-	Differential TMDS Data 2-
4	TMDS1+	Differential TMDS Data 1+
5	GND	Ground
6	TMDS1-	Differential TMDS Data 1-
7	TMDS0+	Differential TMDS Data 0+
8	GND	Ground
9	TMDS0-	Differential TMDS Data 0-
10	TMDSCLK+	Differential TMDS Clock+

Pin	Signal	Description
11	GND	Ground
12	TMDSCLK-	Differential TMDS Clock-
13	CEC	Consumer Electronic Control
14	Reserved	
15	HDMI_SCL	DDC Clock
16	HDMI_SDA	DDC Data
17	HDMI_PLUG	Connect it to GND for cable detection
18	HDMI_VCC	+5V
19	Hot Plug	Hot Plug Detection

### DISPLAYPORT CONNECTOR CN3

Pin	Signal	Description
1	DP3-_IN	Pair-3 negative
2	GND	Ground
3	DP3+_IN	Pair-3 positive
4	DP2-_IN	Pair-2 negative
5	GND	Ground
6	DP2+_IN	Pair-2 positive
7	DP1-_IN	Pair-1 negative
8	GND	Ground
9	DP1+_IN	Pair-1 positive
10	DP0-_IN	Pair-0 negative

Pin	Signal	Description
11	GND	Ground
12	DP0+_IN	Pair-0 positive
13	GND	Ground
14	GND	Ground
15	DPA+_IN	Aux channel positive
16	GND	Ground
17	DPA-_IN	Aux channel negative
18	HPD	Hot Plug Detect
19	Power Return	Return for +3.3V
20	+3.3V_DP	DisplayPort +3.3V

### POWER SUPPLY CONNECTOR CN6

Pin	Signal	Description
Center	+12V	12V Power supply (up to 5A)

Pin	Signal	Description
Bottom	GND	Ground

### POWER SUPPLY CONNECTOR CN18

Pin	Signal	Description
1	+12V	12V Power supply (up to 5A)

Pin	Signal	Description
2	GND	Ground

### OSD CONTROL PANEL CONNECTOR CN7

Pin	Signal	Description
1	+3.3V	+3.3V power
2	GND	Ground
3	LBADC_IN1	Low Bandwidth ADC
4	GND	Ground
5	LED_RED	Status LED red (Sleep Mode)

Pin	Signal	Description
6	LED_GREEN	Status LED green (signal good)
7	NC	Not connected
8	+3.3V	+3.3V power
9	+5V	+5V power
10	GND	Ground

### UART CONNECTOR CN8

Pin	Signal	Description
1	TX	Serial Output
2	RX	Serial Input
3	+3.3V	3.3V Power supply

Pin	Signal	Description
4	+5V	5V Power supply
5	GND	Ground

<b>USB B-TYPE CONNECTOR CN12 (OPTIONAL)</b>		
Pin	Signal	Description
1	VUSB	+5V USB inputpower
2	USBDM	-DATA

Pin	Signal	Description
3	USBDP	+DATA
4	GND	Ground

<b>INTERFACE MODULE CONNECTOR CN13</b>		
Pin	Signal	Description
1	+3.3V_SW	3.3V switched power supply
2	SCL	I2C clock
3	SDA	I2C data

Pin	Signal	Description
4	INTRFC_GPIO	+DATA
5	GND	Ground

<b>Remote control IR-amplifier CN14 (optional)</b>		
Pin	Signal	Description
1	IR	Amplified IR signal
2	+3.3V	3.3V Power supply

Pin	Signal	Description
3	+5V	5V Power supply
4	GND	Ground

<b>LIGHT SENSOR CONNECTOR CN17 (optional)</b>		
Pin	Signal	Description
1	+3.3V	+3.3V power
2	GND	Ground

Pin	Signal	Description
3	SCL	I2C clock
4	SDA	I2C data

## 12 Output Connectors

<b>SPEAKER LEFT OUT CONNECTOR CN4 (OPTIONAL)</b>		
Pin	Signal	Description
1	L-	Left audio negative

Pin	Signal	Description
2	L+	Left audio positive

<b>SPEAKER RIGHT OUT CONNECTOR CN5 (OPTIONAL)</b>		
Pin	Signal	Description
1	R-	Right audio negative

Pin	Signal	Description
2	R+	Right audio positive



LVDS CONNECTOR CN10		
Pin	Signal	Description
1	SVCC	Switched panel power supply +3.3V/ +5V/ +12V (fused)
2		
3	GND	Ground
4		
5	TXB3+	LVDS data 1st pixel
6	TXB3-	LVDS data 1st pixel
7	TXBCL+	LVDS clock 1st pixel
8	TXBCL-	LVDS clock 1st pixel
9	TXB2+	LVDS data 1st pixel
10	TXB2-	LVDS data 1st pixel
11	TXB1+	LVDS data 1st pixel
12	TXB1-	LVDS data 1st pixel
13	TXB0+	LVDS data 1st pixel

Pin	Signal	Description
14	TXB0-	LVDS data 1st pixel
15	TXA3+	LVDS data 2nd pixel
16	TXA3-	LVDS data 2nd pixel
17	TXACL+	LVDS clock 2nd pixel
18	TXACL-	LVDS clock 2nd pixel
19	TXA2+	LVDS data 2nd pixel
20	TXA2-	LVDS data 2nd pixel
21	TXA1+	LVDS data 2nd pixel
22	TXA1-	LVDS data 2nd pixel
23	TXA0+	LVDS data 2nd pixel
24	TXA0-	LVDS data 2nd pixel
25	EBKL	Enable backlight signal

Extra Panel Control Options CN11 (optional)		
Pin	Signal	Description
1	GND	Ground
2	NC	Not connected
3	NC	Not connected
4	NC	Not connected

Pin	Signal	Description
5	NC	Not connected
6	LVDS_OPT_1	+3.3V/GND selectable
7	LVDS_OPT_2	+3.3V/GND selectable
8	LVDS_OPT_3	+5V/+3.3V/GND selectable

BACKLIGHT SUPPLY CONNECTOR CN13		
Pin	Signal	Description
1	BKLT_+12V	Backlight power supply
2	GND	Ground
3	BKLT_EN	Enable backlight signal
4	BRT_ADJ	Brightness control signal
5	NC	Not connected

Pin	Signal	Description
6	NC	Not connected
7	+12V	Backlight power supply
8	+12V	
9	GND	Ground
10	GND	

INTERFACE CONNECTOR CN15 (OPTIONAL)		
Pin	Signal	Description
1	+3.3V	3.3V power supply
2	SCL	I2C clock
3	SDA	I2C data

Pin	Signal	Description
4	INT. GPIO	
5	GND	Ground
6	GND	Ground

HEADPHONE OUT CONNECTOR (3.5mm jack) CN16 (OPTIONAL)		
Pin	Signal	Description
Tip	HPL_OUT	Headphone left
Ring	HPR_OUT	Headphone right

Pin	Signal	Description
Sleeve	GND	Ground

PANEL EXTRA POWER CONNECTOR CN20 (Only from PR-02-211_A1 available Only from PR-01-210_A2 available)		
Pin	Signal	Description
1	LVDS_OPT_0	FW selectable option pin +3.3V/ +5V/ GND
2	SVCC	Panel power supply +3.3V/ +5V/ +12V
3	SVCC	

Pin	Signal	Description
4	GND	Ground
5	GND	Ground

## 13I/O Connector

There are 2 GPIOs connected to CN9, which can be configured as either input or output, using custom firmwares. There also is an I2C connection, for control of external I2C devices.

GPIO CON. CN9		
Pin	Signal	Description
1	+3.3V	3.3V power supply
2	EXT_GPIO_0	External GPIO 0
3	EXT_GPIO_1	External GPIO 1

Pin	Signal	Description
4	SCL	I2C Clock
5	SDA	I2C Data
6	GND	Ground

\*External GPIO pins are open-drain, pulled up to 3.3V by 4.7kohm resistor

## 14 Mechanical Drawing

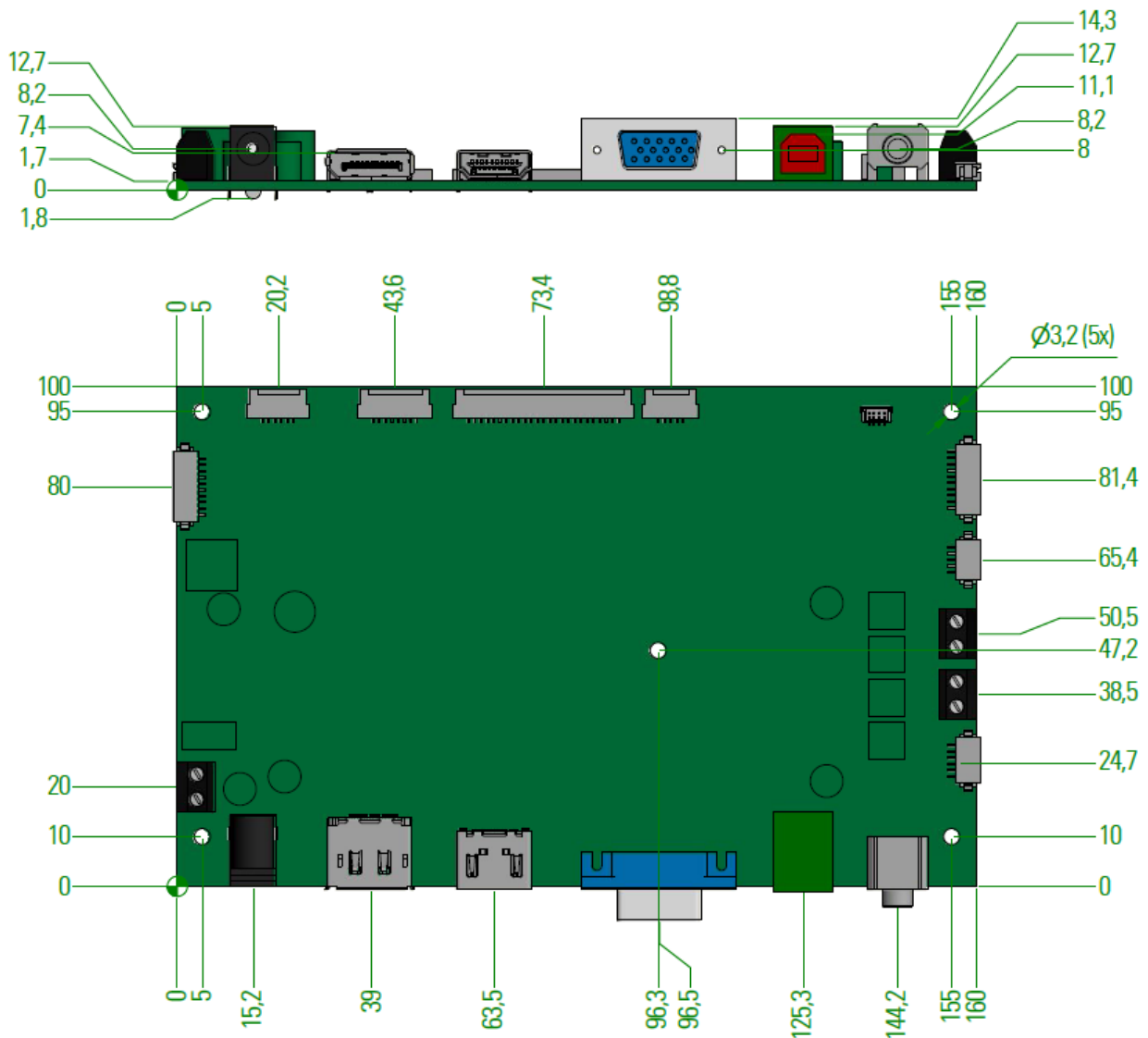

Item	Description	Remarks
Board Length	160 mm	± 0.5 mm
Board Width	100 mm	± 0.2 mm
Board Height	1.7 mm	± 0.1 mm
Total thickness	16.1 mm	-0.2 mm / +0.5 mm
Weight (PR-01-211_A2)	106 g	
Weight (PR-01-210_A3)	125 g	

## 15 Supported Panels and Backlights (Inverter/Converter)

Panels and Backlights Options	Hardware Options
Panel Voltage (SVCC)	3.3V
	5V
	12V
Pixel Per Clock	1
	2
Option Pin 0 Voltage Level (CN20, Panel_Opt)	0V
	3.3V
	5V
Option Pin 1 Logic Level (CN11, LVDS_OPT_1)	0V
	3.3V
Option Pin 2 Logic Level (CN11, LVDS_OPT_2)	0V
	3.3V
Option Pin 3 Voltage Level (CN11, LVDS_OPT_3)	0V
	3.3V
	5V
Backlight Voltage (BKLT_+12V)	12V
Backlight Control Type	PWM
	Analog
Voltage Level of PWM Signal (BRT_ADJ)	3.3V or 5V
Voltage Level (Analog) (BRT_ADJ)	0V – 5V
Voltage Level of Backlight Enable Signal (BKLT_EN)	3.3V or 5V

Our company network supports you worldwide with offices in Germany, Austria, Switzerland, Great Britain and the USA. For more information please contact:

## Headquarters

### Germany



#### FORTEC Elektronik AG

Lechwiesenstr. 9  
86899 Landsberg am Lech

Phone: +49 8191 91172-0  
E-Mail: [sales@fortecag.de](mailto:sales@fortecag.de)  
Internet: [www.fortecag.de](http://www.fortecag.de)

## Fortec Group Members

### Austria



#### FORTEC Elektronik AG

##### Office Vienna

Nuschinggasse 12  
1230 Wien

Phone: +43 1 8673492-0  
E-Mail: [office@fortec.at](mailto:office@fortec.at)  
Internet: [www.fortec.at](http://www.fortec.at)

### Germany



#### Distec GmbH

Augsburger Str. 2b  
82110 Germering

Phone: +49 89 894363-0  
E-Mail: [info@distec.de](mailto:info@distec.de)  
Internet: [www.distec.de](http://www.distec.de)

### Switzerland



#### ALTRAC AG

Bahnhofstraße 3  
5436 Würenlos

Phone: +41 44 7446111  
E-Mail: [info@altrac.ch](mailto:info@altrac.ch)  
Internet: [www.altrac.ch](http://www.altrac.ch)

### Great Britain



#### Display Technology Ltd.

5 The Oaks Business Village  
Revenge Road, Lordswood  
Chatham, Kent, ME5 8LF

Phone: +44 1634 672755  
E-Mail: [info@displaytechnology.co.uk](mailto:info@displaytechnology.co.uk)  
Internet: [www.displaytechnology.co.uk](http://www.displaytechnology.co.uk)

### USA



#### Apollo Display Technologies, Corp.

87 Raynor Avenue,  
Unit 1 Ronkonkoma,  
NY 11779

Phone: +1 631 5804360  
E-Mail: [info@apollodisplays.com](mailto:info@apollodisplays.com)  
Internet: [www.apollodisplays.com](http://www.apollodisplays.com)