

Datasheet

PrismaCOMPACT-Media

All-In-One RGB/ HDMI/DP Converter Board

For VGA – WUXGA Panels

PR-02-220_A1



Version 1.7

13.06.2017

The information contained in this document has been carefully researched and is, to the best of our knowledge, accurate. However, we assume no liability for any product failures or damages, immediate or consequential, resulting from the use of the information provided herein. Our products are not intended for use in systems in which failures of product could result in personal injury. All trademarks mentioned herein are property of their respective owners. All specifications are subject to change without notice.



Table of Contents

1	Revision History	4
2	Overview	5
3	General Features	5
4	Hardware Features	6
5	Input / Output Interfaces.....	7
6	OSD Menu and User Controls	8
6.1	OSD Control Through Keypad.....	8
6.2	OSD Control through IR Remote Control (optional)	9
7	On-Screen-Menu	9
7.1	General Features	9
7.1.1	Color Sub-Menu	10
7.2	Display Menu	11
7.3	System Menu	12
7.3.1	Input Sub-Menu	12
7.3.2	OSD Settings Sub-Menu	13
7.3.3	OSD Hotkeys:	15
7.3.4	Reset	17
7.3.5	EDID Write Protect	17
7.3.6	Auto-Brightness (Optional)	18
7.3.7	Scan Direction.....	18
8	Supported Input Modes	19
8.1	VGA.....	19
8.2	HDMI – Graphics	19
8.3	HDMI – Video.....	19
8.4	DisplayPort	20
9	Absolute Maximum Ratings	20
10	Electrical Characteristics	20
10.1	Maximal allowed power consumption for TFT Panels (V_{DISP}).....	20
10.2	Maximal allowed power consumption for backlight inverter (VBKL)	21
10.3	Thermal Derating Characteristics	21
11	Connector Overview.....	22
11.1	Input Connectors.....	22
11.2	Output Connectors.....	24



12 Mechanical Drawing	25
13 Optional Accessories	26
13.1 CP Input Board IF396.....	26
13.2 External 4+1 Button OSD Keypad	28
13.3 Single Input Cables (Power Cable, DVI, VGA, RS232/UART interface).....	30
14 Supported Panels and Backlights (Inverter/Converter)	31



1 Revision History

Date	Rev.No.	Description	Page
30.01.2013	1.0.0	Release of preliminary data sheet	
11.04.2013	1.0.1	<ul style="list-style-type: none">• Dimensions (general features) and board thickness (mech-data) added• External keypad changed from IF378 to TBD• OSD menu adjusted: Scan direction replaced advanced HW settings• Electrical characteristics table updated	3, 6, 17, 24, 27
07.06.2013	1.1.0	Define Optional Accessories chapter 15 Change OSD Control chapter 6.1	6, 24-28
18.11.2014	1.2	Applied new document template Marked Pin-1s in Pinout drawing Changed OSD captions Added Auto-brightness	19, 8-17
22.04.2015	1.3	Resolution 1280 x 800 added in chapter 7.1, 7.2 and 7.4	18
15.01.2016	1.4	Maximal allowed power consumption added in chapter 15 Thermal Derating Characteristics added in chapter 15.3 Last page updated	20 21 33
26.04.2016	1.5	Company logo updated HDMI version updated	All 5, 6
19.07.2016	1.6	Added General Features	5
13.06.2017	1.7	Changed DDC2B to DDC/CI Changed Lead-free to RoHS Changed Input / Output Picture Changed Connector Overview Chapter Number Added Weight Added Chapter 14 Supported Panels and Backlights Removed Chapter 16 "News and Updates"	5 5 7 22 25 31 32



2 Overview

The PrismaCompact-Media is a powerful graphics processing board, providing high-quality images for TFT/LCD panels. This converter supports 6/8-bit LVDS panels up to WUXGA (1920 x 1200) and can be used in a variety of systems.

3 General Features

- Zoom and shrink scaling
- Faroudja RealColor processing
- Supports VESA DDC/CI and a subset of VESA DPMS standards
- PWM or voltage controlled backlight intensity
- 12V main power input
- Four-button on-board or external OSD - keypad interface and on-screen menus allow adjustments to the system
- True High Definition 1080p on HDMI 1.4 input
- DisplayPort 1.1a input up to 2560x1600 @ 60Hz
- Analog RGB/VGA input captures 1920 x 1200 @ 60Hz
- Serial remote control capability (Remote OSD via PC) - ask sales for serial protocol paper
- RoHS
- 15.75 to 68KHz Legacy Timings
- Analog RGB Sync On Green Capable
- RS170 and RS343 Video Input Option (progressive mode only, framerate limited to panel framerate)
- Dimensions: 130mm x 70mm x 8mm (height 7mm without buttons)



4 Hardware Features

Analog RGB Input

- Supports up to 1792x1344@60Hz or 1920x1260Hz@60Hz or 1600x1200@75Hz standard modes
- Supports up to 1920x1440@60Hz or 2128x1200@ 60Hz with reduced blanking
- Captures up to 205MHz

Ultra-Reliable HDMI 1.4 Receiver

- Single Link TMDS Rx for up to 12-bit 1080p
- Captures up to 225MHz
- Direct connect to all HDMI compliant TMDS transmitters
- HDCP support

DisplayPort Receiver

- 10.8Gbps total bandwidth over 4 lanes
- 2560x1600@60Hz input support at 12-bit
- HDCP support

LVDS Interface

- Fully programmable LVDS mappings for compliance with all LVDS protocols

Auto-Configuration / Auto-Detection

- Phase and image positioning
- Input format detection

On Screen Display

- Horizontal and vertical stretch of OSD images
- 16 levels of blending

Output Format

- Single/double wide LVDS up to WUXGA 60Hz output
- Support for 8 or 6-bit panels (with high-quality dithering)



5 Input / Output Interfaces

The following drawing shows the input and output interfaces of the PrismaCompact-Media.

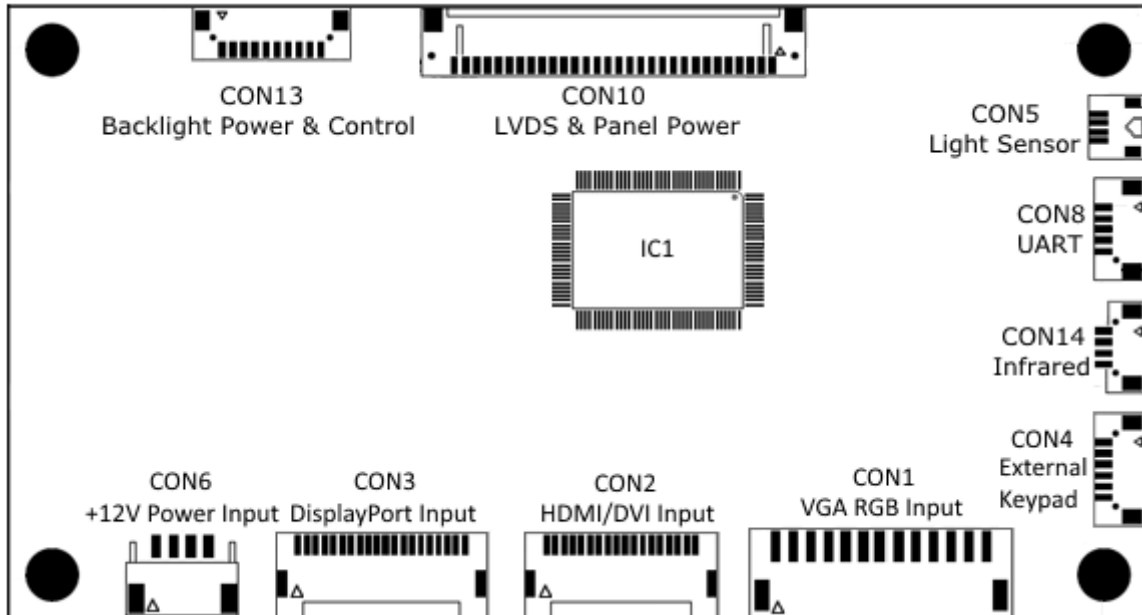



6 OSD Menu and User Controls

The OSD allows selection of input source and fine tuning of various functional parameters like brightness, contrast etc. These parameters can be adjusted via an external interface.

6.1 OSD Control Through Keypad

User can use all OSD functions with 4 buttons near the top right corner of the board. The power on/off button can also be found there.

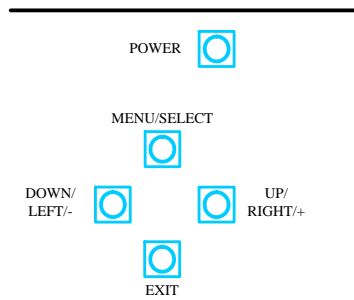

The PrismaCompact-Media will also be able usable with an external 4-button keypad. Mechanical Information of the new keypad will be found under the [optional accessories section \(15.2\)](#).

The four buttons of the OSD control can either be used to navigate within the OSD or to access various functions directly. The following two tables give you an overview about the functionality.

Status	Menu	Down / Left / -	UP / Right / +	Exit	Power
OSD is closed	Open OSD	Hotkey	Hotkey	Hotkey	
OSD is open	Select	Down	Up	Exit/Back	
Active item	Enter	Left / -	Right / +	Back	
Power is On					Power Off
Power is Off					Power On

The green/red LEDs (single package) on the external keypad of the PrismaCompact-Media show the current status of the board:

Status LEDs

Color	Meaning
Green	Normal operation
Green blink	Input search
Red	Sleep mode
No light	Power-OFF mode



6.2 OSD Control through IR Remote Control (optional)

The PrismaCompact-Media can be controlled through an optional remote controller. Please contact sales for further information.

7 On-Screen-Menu

7.1 General Features

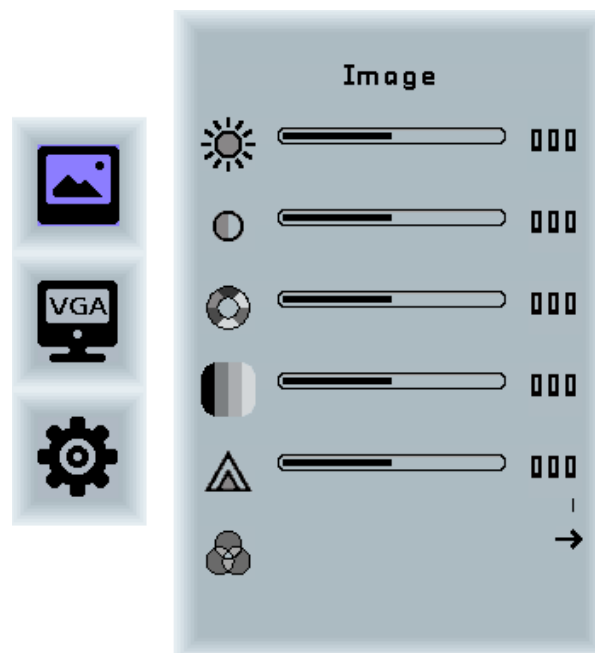

Brightness: Brightness of the image can be controlled using this function, with left and right buttons after the brightness slider is selected. This function modifies RGB data to change the brightness.

Contrast: Allows <Contrast> adjustment in the Y domain. The modification affects all color channels and all input types and is a direct multiplication of the Y data after YUV black level adjustment.

Hue: Allows <Hue> adjustment in the UV domain. The modification affects all color channels and all input types. Available if color space of input is not RGB.

Saturation: Allows <Saturation> adjustment in the UV domain. The modification affects all color channels and all input types. Available if color space of input is not RGB.

Sharpness: Allows <Sharpness> adjustment on the image.

Color: Opens the color sub-menu.



7.1.1 Color Sub-Menu



Auto: Performs auto-color adjustment.

Full color: Selects full received color space.

sRGB: Selects sRGB color space.

xycc: Selects xycc color space.

Color Temp: Allow selection of different color temperature schemes, predefined and custom. Available if color space of input is RGB.

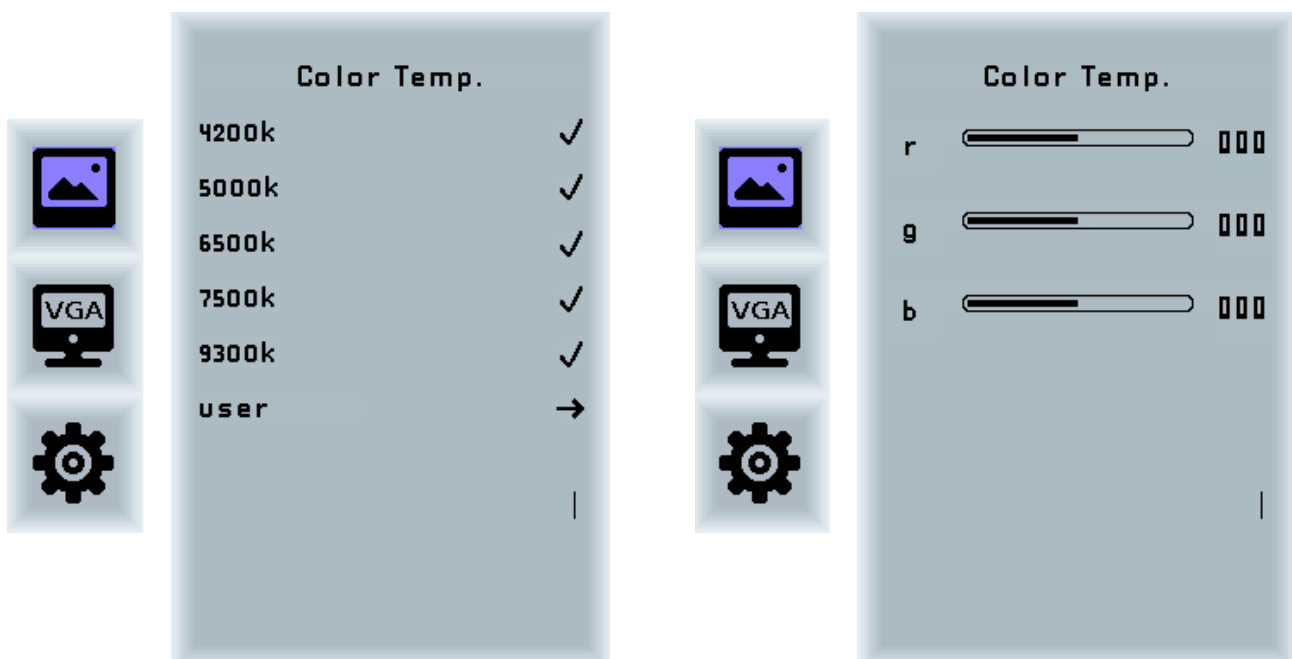



7.2 Display Menu

Available if source is VGA input.

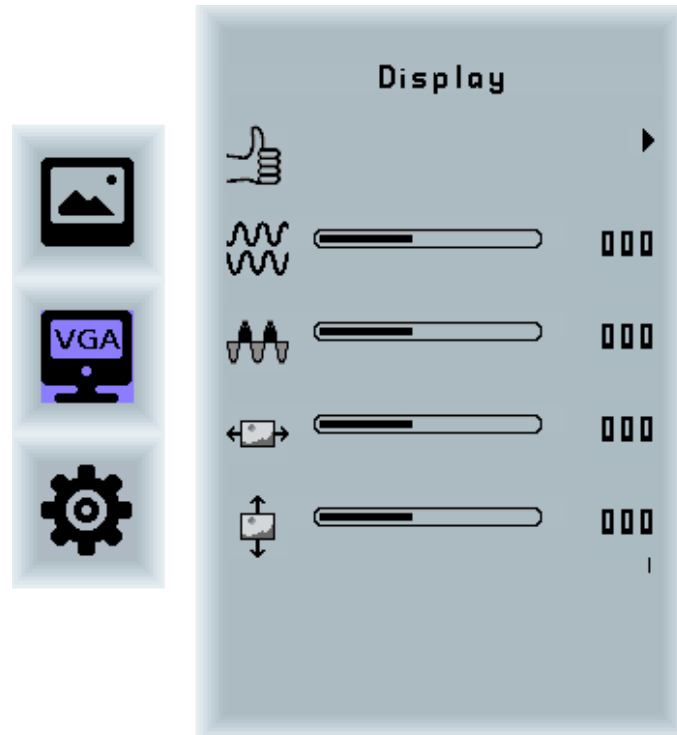

- Auto-adjust:** Performs auto-adjustment on the VGA input image.
- Phase:** This function is a slider to adjust the sampling phase of the analog interface. For optimum image quality, input pixels should be sampled at the ideal sampling points.
- Clock:** This function is a slider to adjust the sample clock of the analog interface. This is helpful for improving the image quality for non-standard display modes.
- Horizontal:** Used to alter placement of the image on the horizontal.
- Vertical:** Used to alter placement of the image on the vertical.



7.3 System Menu

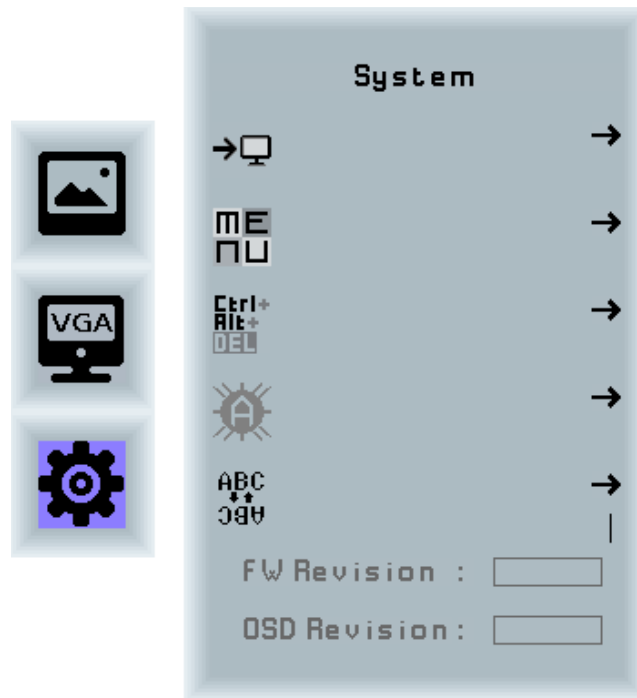

Contains input sub-menu, OSD settings sub-menu, factory reset, EDID sub-menu, scan direction sub-menu and FW/OSD revision information.

7.3.1 Input Sub-Menu

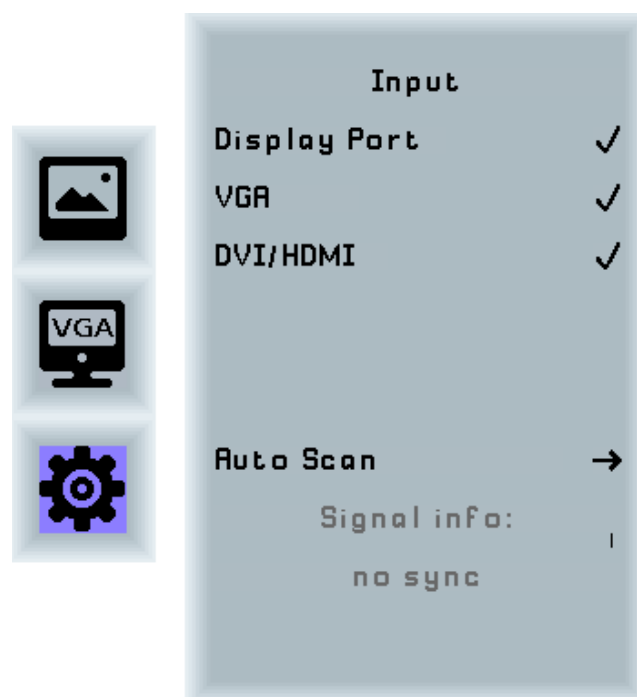

- Manual selection of input



Auto-Scan: Enable/disable input auto-scan

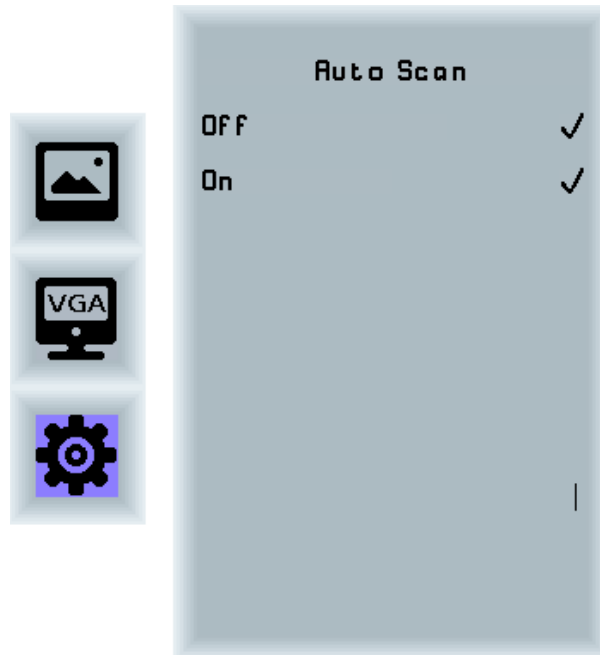

7.3.2 OSD Settings Sub-Menu

Contains timer, rotation, horizontal/vertical position adjustment and transparency.

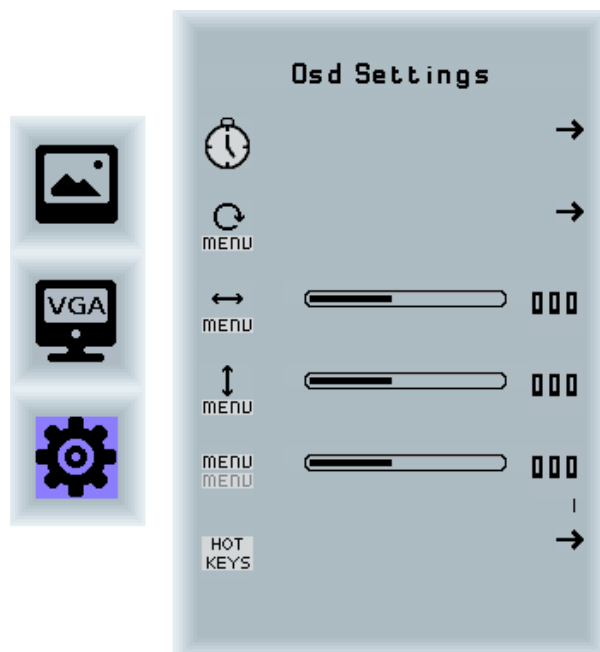



Timer: Selects how many seconds the OSD will remain active after the last use

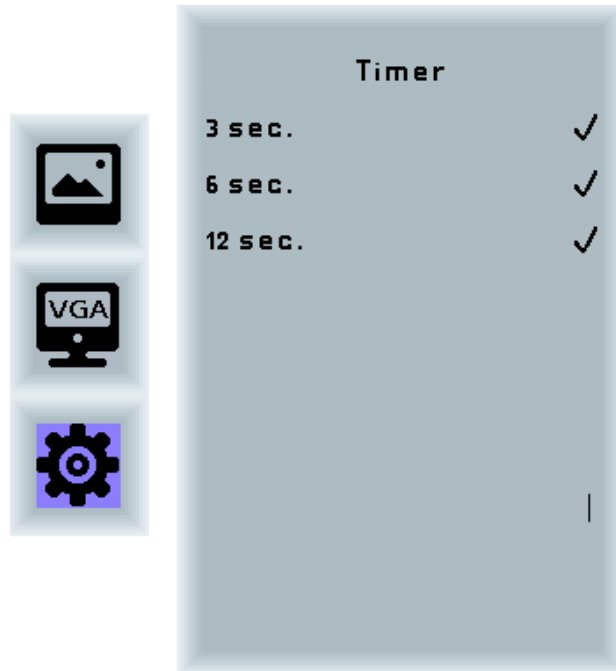

Rotation: Rotates the OSD menu

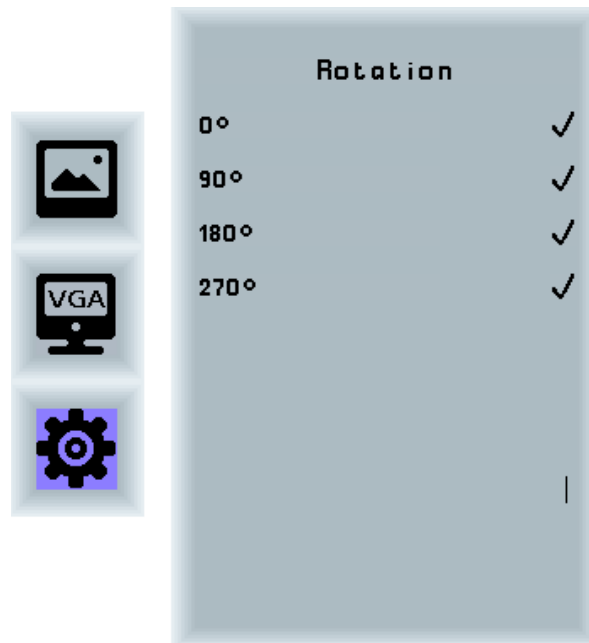

Horizontal: Used to alter placement of the OSD on the horizontal.

Vertical: Used to alter placement of the OSD on the vertical.

Transparency: Selects OSD blending with background



7.3.3 OSD Hotkeys:

Contains Left, Right, Exit key sub menus for Hotkey function selection, which are activated while the OSD menu is closed.

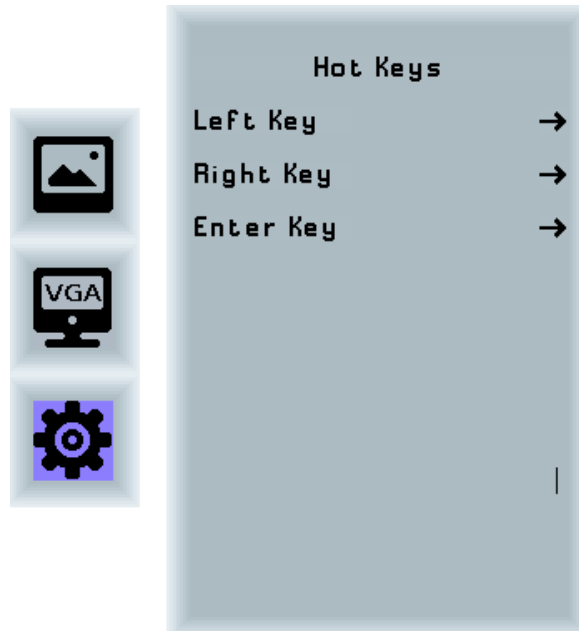

- Left key:** Assigns the left hotkey function:
- 1) Not used (default)
 - 2) Decrease brightness by 1 (over 100)
 - 3) Open the brightness slider bar





Right key: Assigns the right hotkey function:

- 1) Not used (default)
- 2) Increase brightness by 1 (over 100)
- 3) Open the contrast slider bar

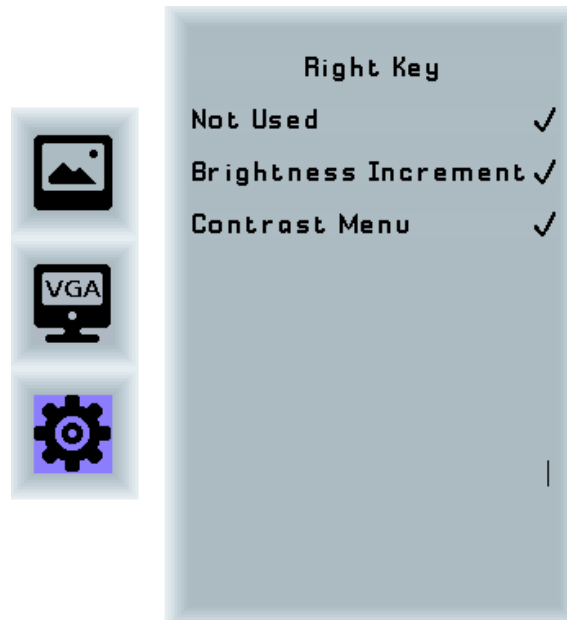

Exit key: Assigns the enter hotkey function:

- 1) Not used (default)
- 2) Open source selection menu, cycle through inputs upon further presses
- 3) (VGA only) Opens source selection menu, but if key is kept pressed for three seconds or longer, does auto-color instead of opening source menu. This function works on release of the key, unlike other OSD functions which work on press of the key.

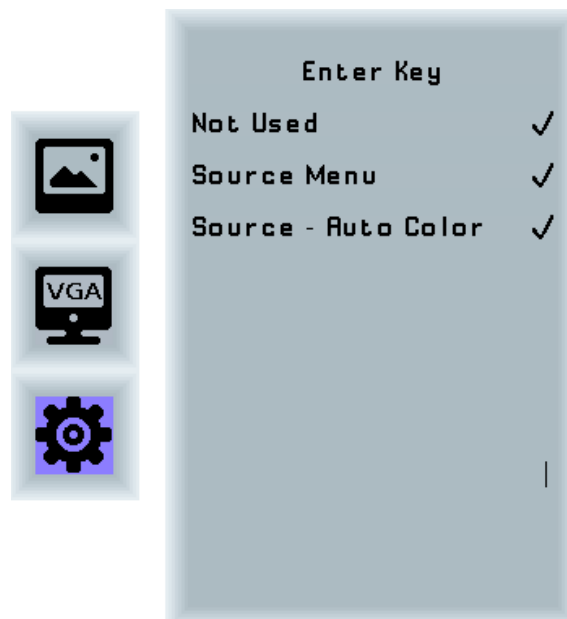

*If input is not VGA, enter hotkey with 3rd function selection acts as the 2nd function and opens the source menu upon key press.



7.3.4 Reset

Reset: Performs a factory reset and returns all settings to default values.

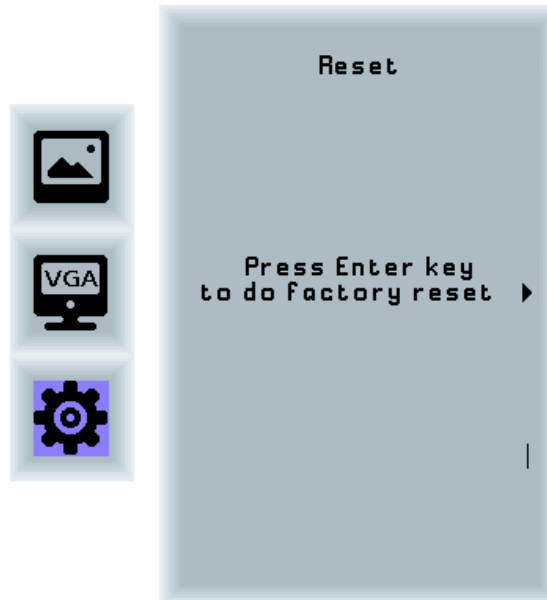

7.3.5 EDID Write Protect

This menu only exists in Firmware version below 2.0.0.

EDID Write Protect: Toggles EDID write protect on or off.





7.3.6 Auto-Brightness (Optional)

Auto-Brightness: This sub menu and corresponding icon appears only if an ambient light sensor is installed on the PrismaCompact-Media.

If this feature is enabled, brightness of the panel will be regulated according to the brightness value read from the ambient light sensor. When auto brightness feature is on, brightness slider in Image menu will be no longer selectable, however it will show the value of brightness calculated according to the ambient light sensor at a time.

This feature is available with firmware version 2.0.0 and above.

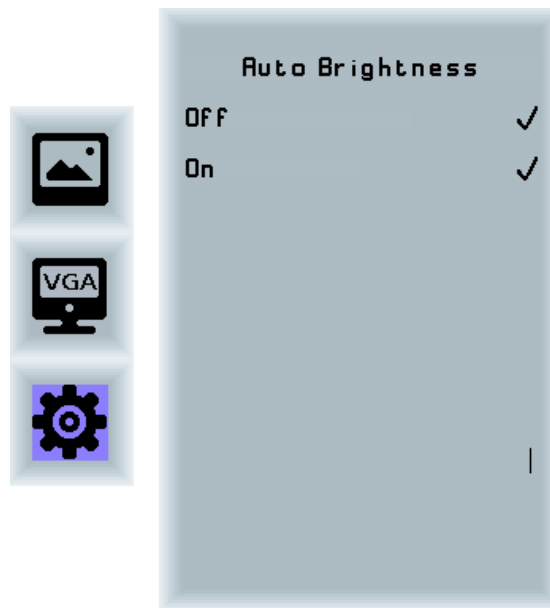

7.3.7 Scan Direction

Scan Direction: This sub-menu is displayed under the system menu only for panels that have a scan direction select pin/connection. It chooses which direction the image is displayed. The resulting direction change (vertical or horizontal or both) will depend on the panel used.





8 Supported Input Modes

The PrismaCompact-Media can support the following input modes.

8.1 VGA

The PrismaCompact-Media is equipped with one VGA connector CN1.
The factory preset supported input modes include:

Resolution	Resolution
640 x 480 @ 60 Hz (VESA)	1360 x 768 @ 60 Hz
800 x 600 @ 60 Hz (VESA)	1366 x 768 @ 60 Hz
1024 x 768 @ 60 Hz (VESA)	1368 x 768 @ 60 Hz
1280 x 768 @ 60 Hz	1600 x 1200 @ 60 Hz (VESA)
1280 x 800 @ 60 Hz	1920 x 1200 @ 60 Hz
1280 x 1024 @ 60 Hz (VESA)	1920 x 1080 @ 60 Hz

8.2 HDMI – Graphics

The PrismaCompact-Media is equipped with the HDMI connector, CN2.
The factory preset supported input modes include:

Resolution	Resolution
640 x 480 @ 60 Hz (VESA)	1360 x 768 @ 60 Hz
800 x 600 @ 60 Hz (VESA)	1366 x 768 @ 60 Hz
1024 x 768 @ 60 Hz (VESA)	1368 x 768 @ 60 Hz
1280 x 768 @ 60 Hz	1600 x 1200 @ 60 Hz (VESA)
1280 x 800 @ 60 Hz (VESA)	1920 x 1200 @ 60 Hz
1280 x 1024 @ 60 Hz (VESA)	1920 x 1080 @ 60 Hz

8.3 HDMI – Video

The factory preset supported input modes include:

Resolution	Resolution
720 x 480 @ 60	1280 x 720 @ 60
720 x 576 @ 50	1920 x 1080 @ 50
1280 x 720 @ 50	1920 x 1080 @ 60



8.4 DisplayPort

The PrismaCompact-Media is equipped with one DP connector, CN3.
The factory preset supported input modes include:

Resolution	Resolution
640 x 480 @ 60 Hz (VESA)	1366 x 768 @ 60 Hz
800 x 600 @ 60 Hz (VESA)	1368 x 768 @ 60 Hz
1024 x 768 @ 60 Hz (VESA)	1600 x 1200 @ 60 Hz (VESA)
1280 x 800 @ 60 Hz	1920 x 1200 @ 60 Hz
1280 x 1024 @ 60 Hz (VESA)	1920 x 1080 @ 60 Hz
1360 x 768 @ 60 Hz	

9 Absolute Maximum Ratings

Item	Symbol	Min.	Max.	Unit	Note
Supply Voltage	$V_{in(12V)}$	0	14	VDC	1, 2, 3
Storage Temperature	T_{St}	-35	+85	°C	
Operating Temperature	T_{Op}	-20	+80	°C	

10 Electrical Characteristics

Remark: All values are average values of repeated measurements. Other PrismaCompact-Media types or PrismaCompact-Media/panel combinations can have different electrical characteristics.

All measurements done at 25°C ambient temperature.

Item	Condition	MIN.	TYP.	MAX.	Unit	Note
Supply Voltage		11.7	12.0	12.3	VDC	1
Current Consumption (12V)	Power-OFF		15		mA	
	Sleep mode		25		mA	
	Board only		85		mA	
G170EG01V1 panel	SXGA, Moire-Y, 100% BRT		1.47		A	

10.1 Maximal allowed power consumption for TFT Panels (V_{DISP})

Item	Symbol	Min.	Max.	Unit
3.3V (5V) (V_{DISP}) Panel power	IDISP	1.3 (1.5)	A	4), 5), 6)



10.2 Maximal allowed power consumption for backlight inverter (VBKL)

Item	Symbol	Max.	Unit	Unit
+5V Backlight power on CON13	IBKL			Optional
+12V Backlight power on CON13	IBKL	2.4	A	6)

10.3 Thermal Derating Characteristics

The following graph shows the external power consumption vs. temperature characteristics of the PrismaCOMPACT-Media. The detailed limits for each output are described above.

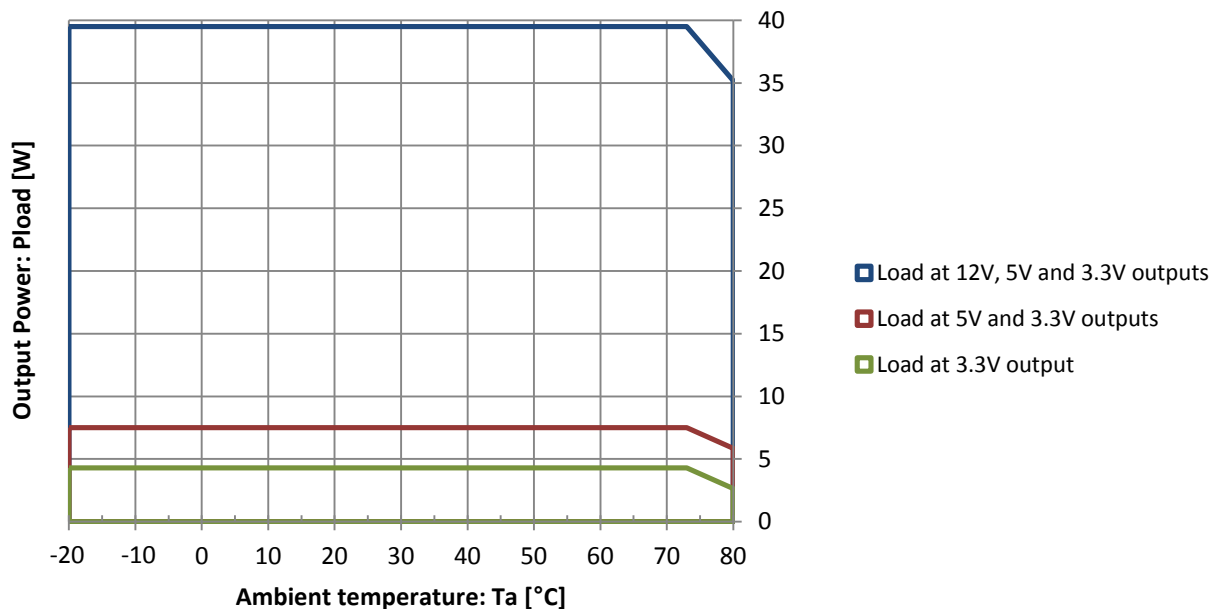

Notes:

- 1) Within operating temperature range.
- 2) Supply voltage limits are for the PrismaCompact-Media, panel/inverter supply limits must be met as well, if the panel is +12V and the inverter is to be powered through the PrismaCompact-Media board.
- 3) Permanent damage to the device may occur if maximum values are exceeded.
- 4) The 3.3V power consumption should not exceed 4.3W at the ambient temperature of 70°C.
- 5) The amount of the 5V and 3.3V power consumption should not exceed 7.5W at the ambient temperature of 70°C.
- 6) The amount of the 12V, 5V and 3.3V power consumption should not exceed 39.5W at the ambient temperature of 70°C.



11 Connector Overview

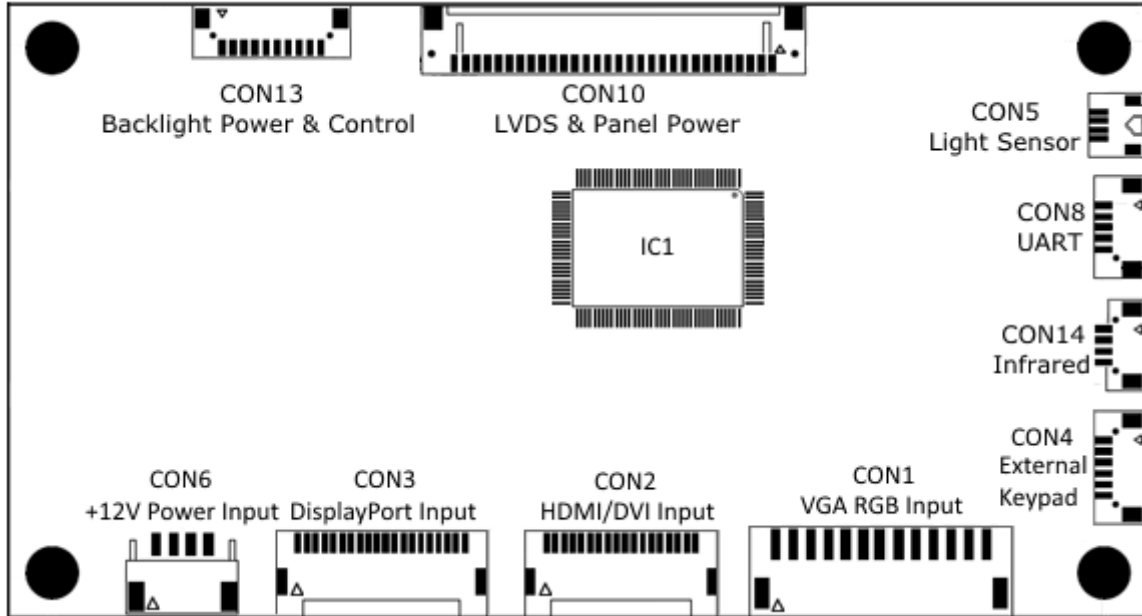

CON	DESCRIPTION	TYPE	MANUFACTURER
CON1	VGA RGB Input	S13B-PH-SM3-TB(LF)(SN)	JST
CON2	HDMI/DVI Input	2203H-18-T-R	Nexus
CON3	DisplayPort Input	2203H-20-T-R	Nexus
CON4	External Keypad	DF13-6P-1.25H (21)	Hirose
CON5	Light Sensor	501568-0407	Molex
CON6	+12V Power Input (4A max)	S4B-PH-SM3-TB(LF)(SN)	JST
CON8	UART/GProbe	DF13-5P-1.25H	Hirose
CON10	Dual LVDS & Panel Power	DF14-30P-1.25H	Hirose
CON13	Backlight Power &Control	DF13-10P-1.25H	Hirose
CON14	Infrared	DF13-4P-1.25H-21	Hirose

11.1 Input Connectors

VGA RGB – ANALOG INPUT CON1:

Pin	Signal	Description
1	VGA_HS_IN	Horizontal Sync Input
2	GND	Ground
3	VGA_VS_IN	Vertical Sync Input
4	VGA_5V	+5V from source
5	VGA_BLUE_IN	Analog Blue
6	GND	Ground
7	VGA_GREEN_IN	Analog Green

Pin	Signal	Description
8	GND	Ground
9	VGA_RED_IN	Analog Red
10	GND	Ground
11	VGA_SCL	DDC Clock
12	VGA_SDA	DDC Data
13	VGA_PLUG	Connect to DSUB15 pin-5



HDMI/DVI CONNECTOR CON2:

Pin	Signal	Description
1	HDMI_HP	Source Hot Plug Detection
2	HDMI_VCC	+5V
3	HDMI_PLUG	Sink cable plug detection*
4	HDMI_SDA	DDC Data
5	HDMI_SCL	DDC Clock
6	CEC	Optional HDMI CEC
7	HDMI_RXC-_IN	Differential TMDS Clock-
8	GND	Ground
9	HDMI_RXC+_IN	Differential TMDS Clock+

Pin	Signal	Description
10	HDMI_RX0-_IN	Differential TMDS Data 0-
11	GND	Ground
12	HDMI_RX0+_IN	Differential TMDS Data 0+
13	HDMI_RX1-_IN	Differential TMDS Data 1-
14	GND	Ground
15	HDMI_RX1+_IN	Differential TMDS Data 1+
16	HDMI_RX2-_IN	Differential TMDS Data 2-
17	GND	Ground
18	HDMI_RX2+_IN	Differential TMDS Data 2+

* Connect to standard HDMI connector pin-17 or standard DVI connector pin-15 (both are ground)

DISPLAYPORT CONNECTOR CON3:

Pin	Signal	Description
1	+3.3V_DP	DisplayPort +3.3V
2	Power Return	Return for +3.3V
3	HPD	Hot Plug Detect
4	DPA-_IN	Aux channel negative
5	GND	Ground
6	DPA+_IN	Aux channel positive
7	GND	Ground
8	GND	Ground
9	DP0+_IN	Pair-0 positive
10	GND	Ground

Pin	Signal	Description
11	DP0-_IN	Pair-0 negative
12	DP1+_IN	Pair-1 positive
13	GND	Ground
14	DP1-_IN	Pair-1 negative
15	DP2+_IN	Pair-2 positive
16	GND	Ground
17	DP2-_IN	Pair-2 negative
18	DP3+_IN	Pair-3 positive
19	GND	Ground
20	DP3-_IN	DP3-_IN

External Keypad OSD CONNECTOR CON4:

Pin	Signal	Description
1	LBADC_IN1	Low Bandwidth ADC
2	GND	Ground
3	LED_RED	Status LED red

Pin	Signal	Description
4	LED_GREEN	Status LED green (signal good)
5	GND	Ground
6	+3.3V	+3.3V power

LIGHT SENSOR CONNECTOR CON5 (optional):

Pin	Signal	Description
1	+3.3V	+3.3V power
2	GND	Ground

Pin	Signal	Description
3	SCL	I2C clock
4	SDA	I2C data

Power Input POWER SUPPLY CONNECTOR CON6:

Pin	Signal	Description
1	GND	Power return
2	GND	Power return

Pin	Signal	Description
3	+12V	12V supply (4A max)
4	+12V	12V supply (4A max)



UART CONNECTOR CON8:

Pin	Signal	Description
1	TX	Serial Output
2	RX	Serial Input
3	+3.3V	3.3V Power supply

Pin	Signal	Description
4	+5V	5V Power supply
5	GND	Ground

Infrared Remote control CON14:

Pin	Signal	Description
1	IR	Amplified IR signal
2	+3.3V	3.3V Power supply

Pin	Signal	Description
3	+5V	5V Power supply
4	GND	Ground

As described optional items are currently not integrated in the firmware

11.2 Output Connectors

LVDS/Options/Panel Power/CONNECTOR CON10:

Pin	Signal	Description
1	SVCC	Switched panel power supply +3.3V/ +5V
2		
3	GND	Ground
4	TXB3+	LVDS data 1st pixel
5	TXB3-	LVDS data 1st pixel
6	GND	Ground
7	TXBCL+	LVDS clock 1st pixel
8	TXBCL-	LVDS clock 1st pixel
9	GND	Ground
10	TXB2+	LVDS data 1st pixel
11	TXB2-	LVDS data 1st pixel
12	TXB1+	LVDS data 1st pixel
13	TXB1-	LVDS data 1st pixel
14	TXB0+	LVDS data 1st pixel
15	TXB0-	LVDS data 1st pixel

Pin	Signal	Description
16	GND	Ground
17	TXA3+	LVDS data 2nd pixel
18	TXA3-	LVDS data 2nd pixel
19	GND	Ground
20	TXACL+	LVDS clock 2nd pixel
21	TXACL-	LVDS clock 2nd pixel
22	GND	Ground
23	TXA2+	LVDS data 2nd pixel
24	TXA2-	LVDS data 2nd pixel
25	TXA1+	LVDS data 2nd pixel
26	TXA1-	LVDS data 2nd pixel
27	TXA0+	LVDS data 2nd pixel
28	TXA0-	LVDS data 2nd pixel
29	LVDS_OPT_0	Firmware selected 0V/3.3V
30	LVDS_OPT_1	Firmware selected 0V/3.3V

Backlight Power / Control CONNECTOR CON13:

Pin	Signal	Description
1	+12V	Backlight power supply
2	GND	Ground
3	BKLT_EN	Enable backlight signal
4	BRT_ADJ	Brightness control signal
5	NC	Optional 5V backlight supply

Pin	Signal	Description
6	NC	Optional 5V backlight supply
7	+12V	Backlight power supply
8	+12V	
9	GND	Ground
10	GND	



12 Mechanical Drawing

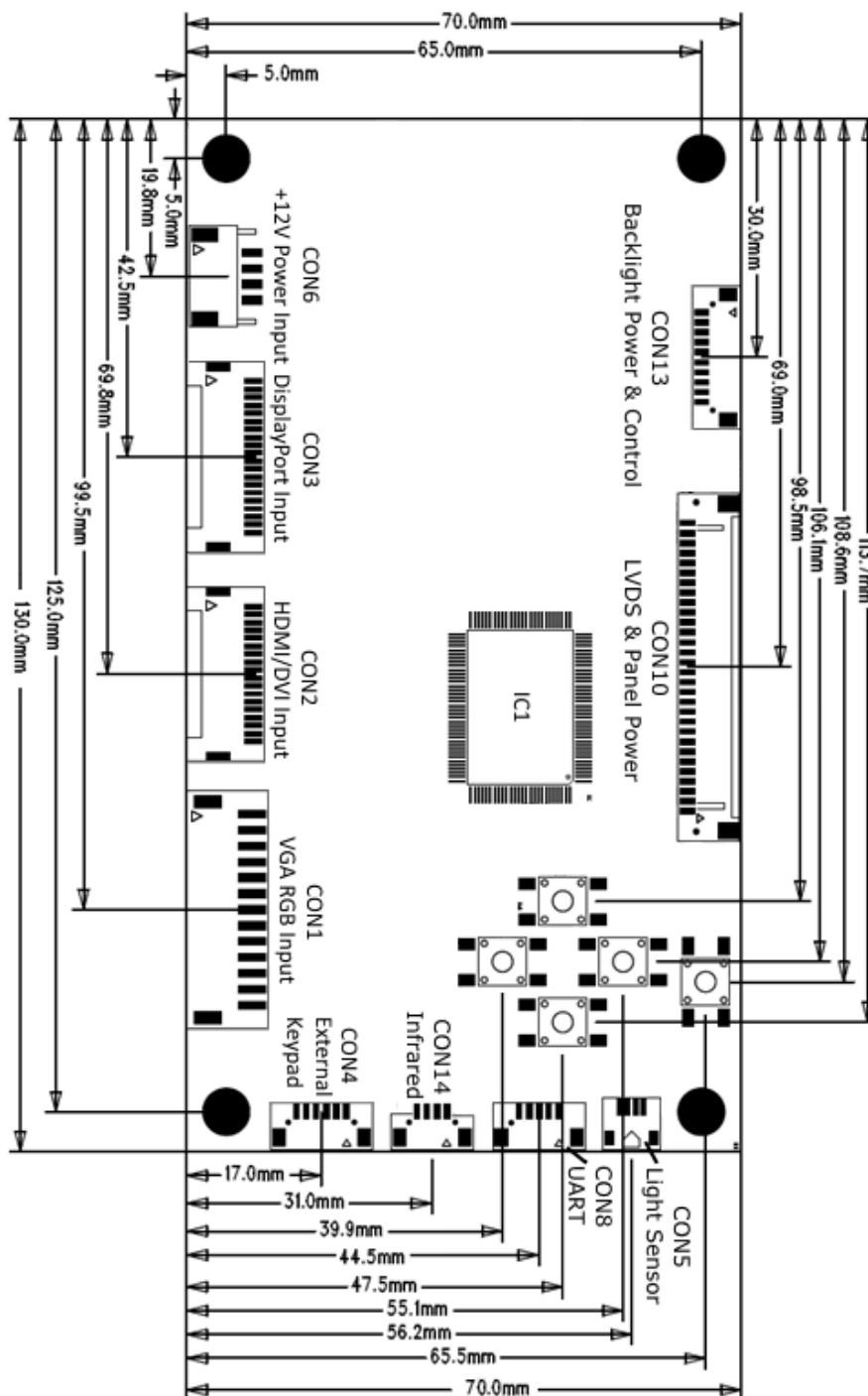

Board thickness (bottom of PCB to top of highest component) = 8mm with buttons, 7mm without buttons.

ITEM	DESCRIPTION	REMARKS
Length	130.0mm	± 0.2mm
Width	70.0mm	± 0.2mm
Weight	40g	



13 Optional Accessories

13.1 CP Input Board IF396

Customers can either make their own connections to the pin header connectors, or if they prefer a ready solution, they can use the input board IF396 and the existing cables between the two boards. The IF396 has standard connectors for power (DC power jack with 2mm pin), DisplayPort, DVI, VGA (DSUB-15), USB (B-type) and RS232 (DSUB-9).

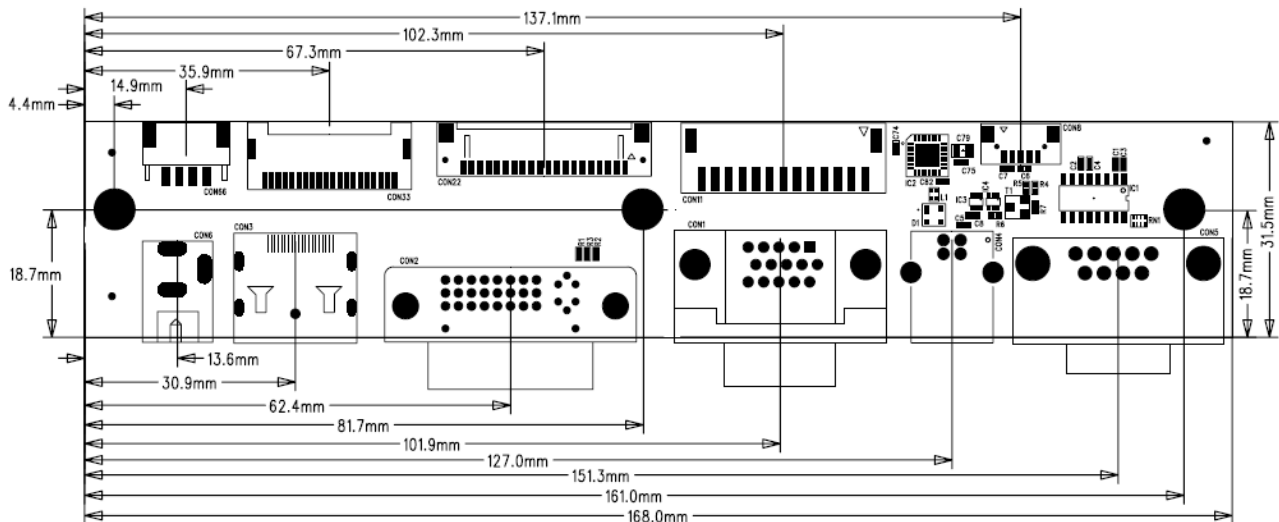
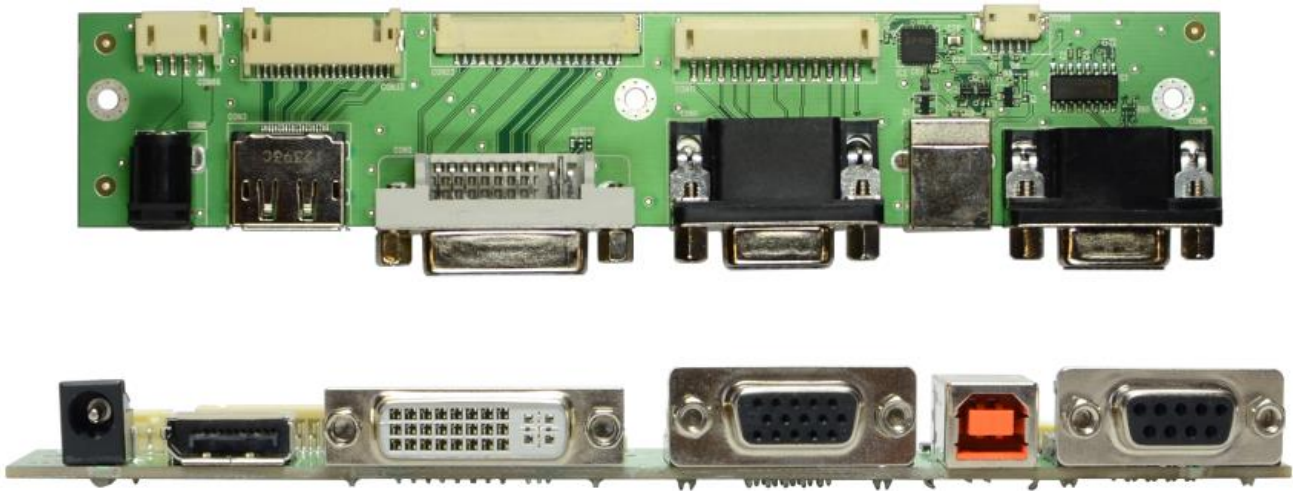

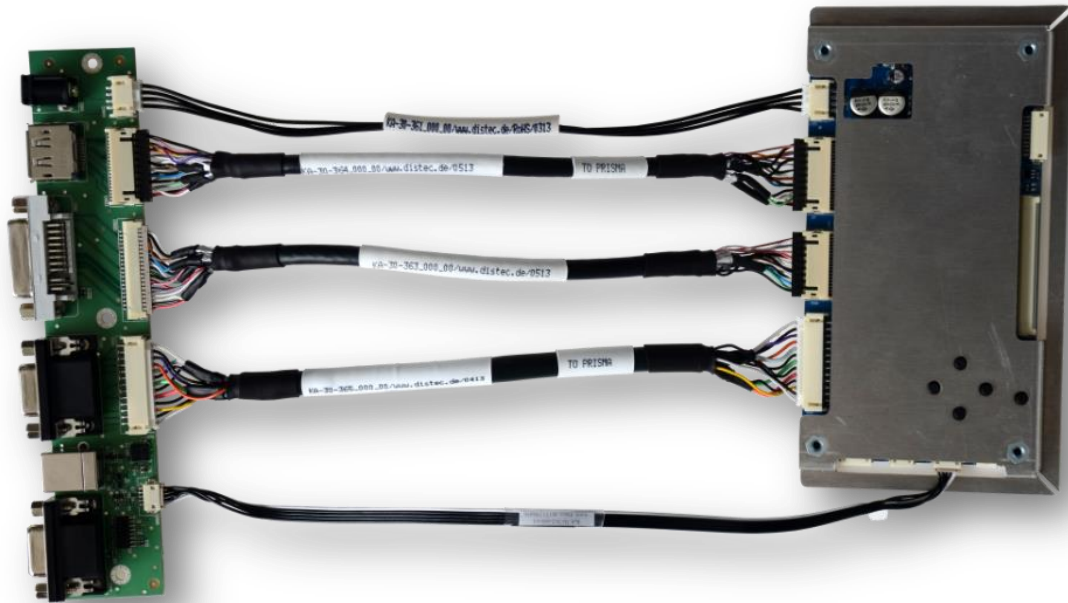

Order number:

KI-90-008 Kit CP-Input Board IF396 incl. cables

Kit including the following components

- ZU-02-396 IF396-00 RDDP-UR Input Board P-C Media
- KA-30-365 Cable RGB IF396/PrismaCompactMedia 20cm
- KA-30-363 Cable DVI IF396/PrismaCompactMedia 20cm
- KA-30-364 Cable DP IF396/PrismaCompactMedia 20cm
- KA-30-361 Cable POW IF396/PrismaCompactMedia 20cm
- KA-30-362 Cable UART IF396/PrismaCompactMedia 25cm



13.2 External 4+1 Button OSD Keypad

The IF398 is a universal OSD Board for all DataDisplay-Group Prisma Artista TFT-Controller families.

It's based on 4 Button OSD menu concepts for an easy, intuitive use without leaving fingers from the buttons, one power button and a status LED.

The PCB layout is symmetrical, mounting holes and buttons have the same distance together.

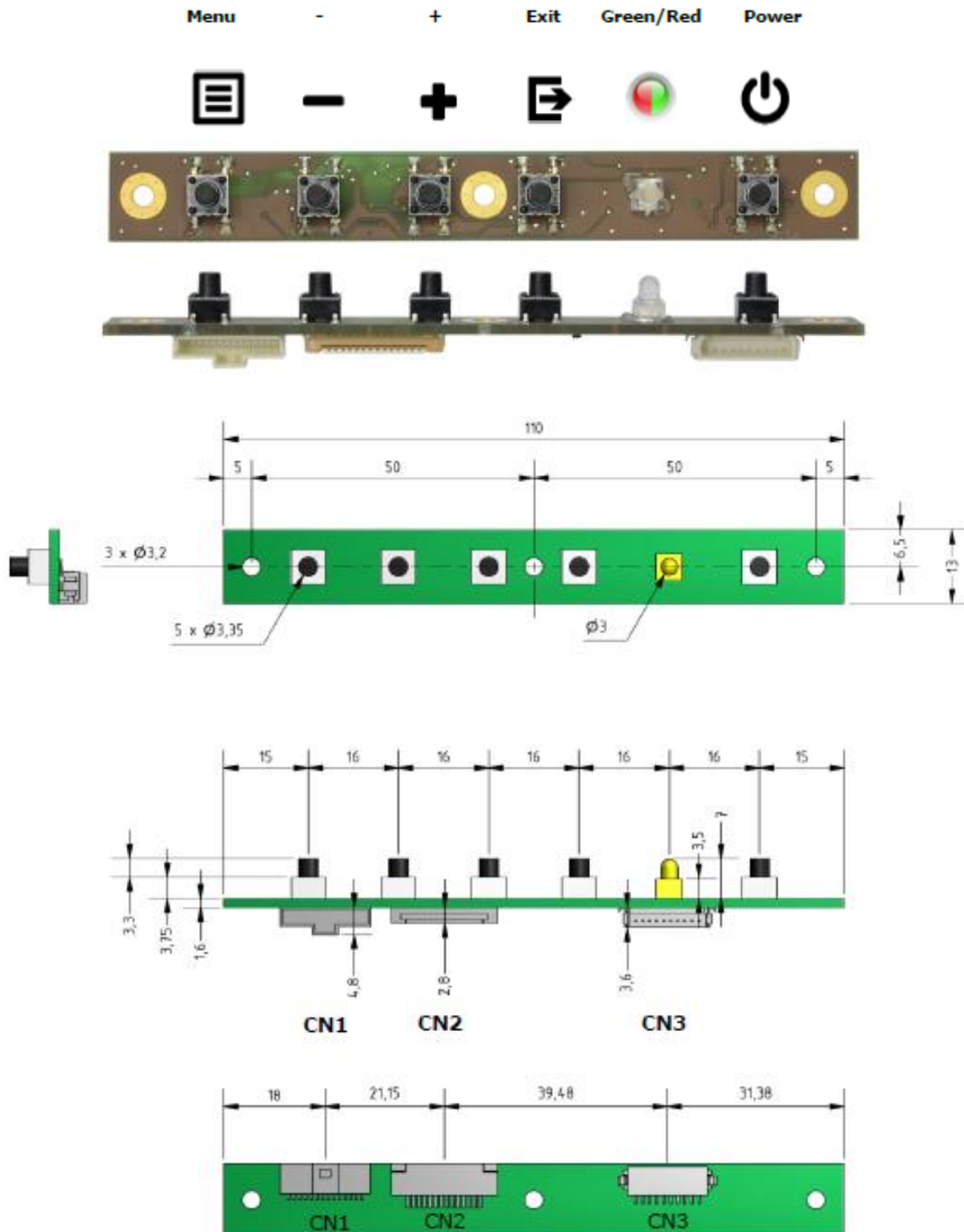

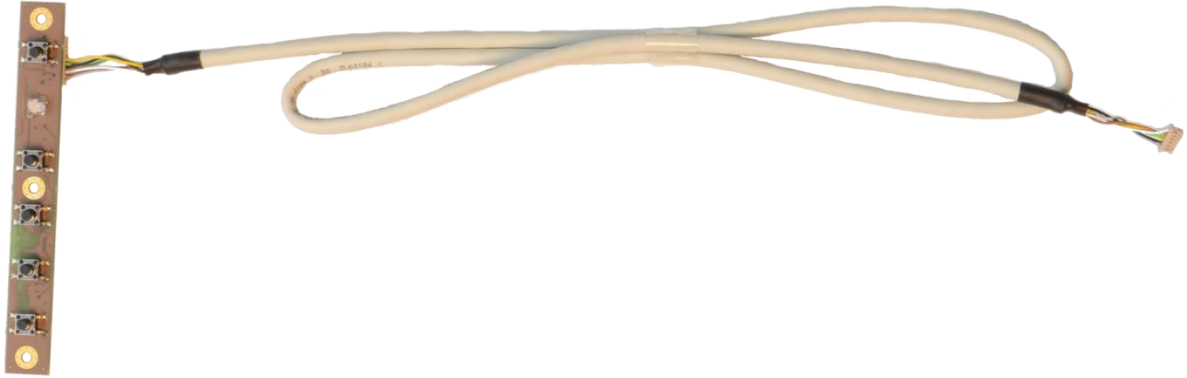

Order number

External 4+1 Button OSD Keypad:

ZU-02-398 IF398-00-OSD-Board-Universal
KA-30-394 Cable OSD IF398/PrismaCompactMedia 80cm



13.3 Single Input Cables (Power Cable, DVI, VGA, RS232/UART interface)

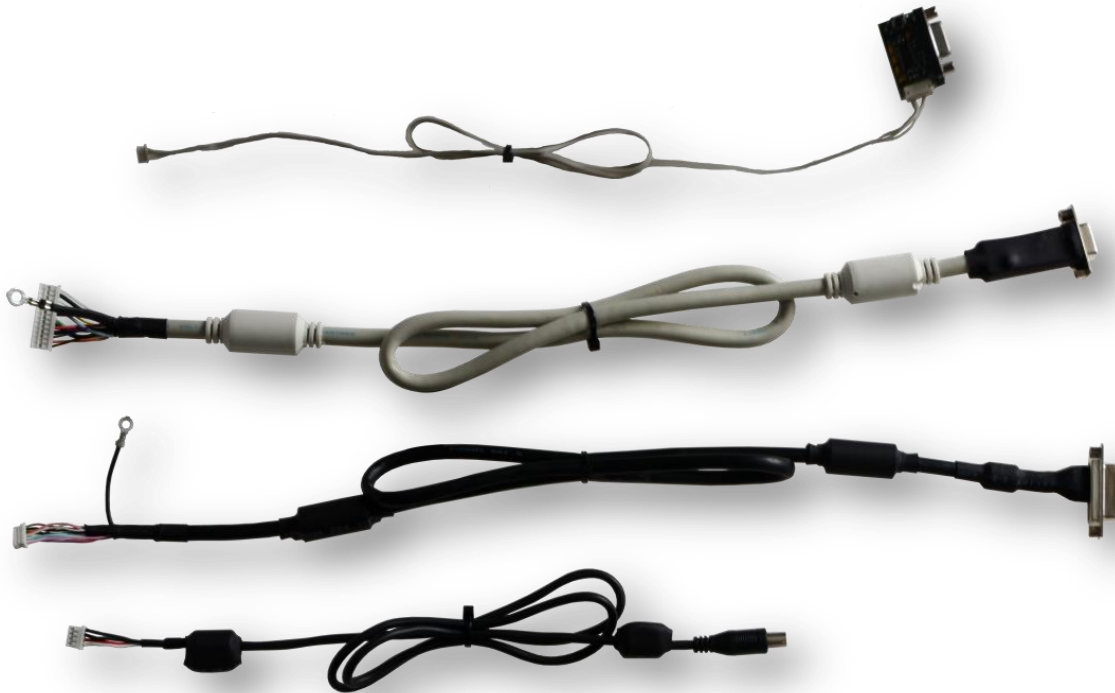

Order numbers

RS232 interface + cable for Remote Control and Firmware update:

ZU-02-370 IF370-00-R10programmingadap.Pris./Art.NET
KA-30-101 Cable Service/Debug ArtistaNET/Pris 80cm

VGA Cable:

KA-03-027 VGA Cable LTM150XI/170EI female 80cm

DVI Cable:

KA-30-382 Cable DVI-D Female / PCompactMedia 80cm

Power Supply Cable:

KA-30-030 Power Supply Cable DI170/190S01 80cm



14 Supported Panels and Backlights (Inverter/Converter)

Panels and Backlights Options (Note 1)	Hardware Options
Panel Voltage	3.3V
	5V
Pixel Per Clock	1
	2
Option Pin 0 Voltage Level	0V
	3.3V
Option Pin 1 Voltage Level	0V
	3.3V
Backlight Voltage	12V
Backlight Control Type	Analog
	PWM
Voltage Level of PWM Signal	3.3V
	5V
Analog Voltage Level Range	0V - 5V
Voltage Level of Backlight Enable Signal	3.3V
	5V

Note 1: This converter supports 6/8-bit LVDS panels up to WUXGA (1920 x 1200) and can be used in a variety of systems.

Our company network supports you worldwide with offices in Germany, Great Britain, Turkey and the USA.
For more information please contact:

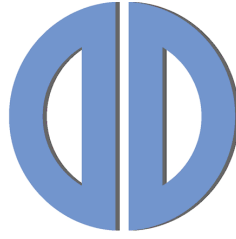

DATA DISPLAY GROUP

A **FORTEC** GROUP MEMBER

Distec GmbH

Augsburger Str. 2b
82110 Germering
Germany

Phone: +49 (0)89 / 89 43 63-0
Fax: +49 (0)89 / 89 43 63-131
E-Mail: info@datadisplay-group.de
Internet: www.datadisplay-group.de

FORTEC Elektronik AG

Lechwiesenstr. 9
86899 Landsberg am Lech
Germany

Phone: +49 (0)8191 / 911 72-0
Fax: +49 (0)8191 / 217 70
E-Mail: sales@fortecag.de
Internet: www.fortecag.de

Display Technology Ltd.

5 The Oaks Business Village
Revenge Road, Lordswood
Chatham, Kent, ME5 8LF
United Kingdom

Phone: +44 (0)1634 / 67 27 55
Fax: +44 (0)1634 / 67 27 54
E-Mail: info@displaytechnology.co.uk
Internet: www.datadisplay-group.com

Apollo Display Technologies, Corp.

87 Raynor Avenue,
Unit 1 Ronkonkoma,
NY 11779

United States of America
Phone: +1 631 / 580-43 60
Fax: +1 631 / 580-43 70
E-Mail: info@apolloDisplays.com
Internet: www.apolloDisplays.com

Sales Partner:

DATA DISPLAY BİLİŞİM TEKNOLOJİLERİ İÇ VE DIŞ TİCARET LİMİTED ŞİRKETİ

Barbaros Mh. Ak Zambak Sk. A Blok D:143
34376 Ataşehir / İstanbul
Turkey

Phone: +90 (0)216 / 688 04 68
Fax: +90 (0)216 / 688 04 69
E-Mail: info@data-display.com.tr
Internet: www.data-display.com.tr